

# Liquid Freezer II 420

Multi Compatible All-In-One CPU Water Cooler



## General Specifications

Socket Compatibility	Intel® 1200, 115X, 2011-3*, 2066* *Square ILM AMD® AM4, AM3(+)
Fan	3 x 140 mm P14 PWM-Fan
TIM	ARCTIC MX-4 included
Noise Level	0.4 Sone @ max. rpm
Dimensions	148 mm (L) x 149.5 mm (W) x 166 mm (H)
Total Weight	1977 g

## Fan Specifications

Speed	200-1700 rpm
rpm Control	Pulse Width Modulation
Noise Level	0.3 Sone
Connector	4-Pin Connector
Bearing	Fluid Dynamic Bearing
Current Voltage	0.12 A/ 12 V DC
Static Pressure	2.4 mm H <sub>2</sub> O
Airflow	72.8 cfm
Dimensions	140 mm (L) x 27 mm (W) x 140 mm (H)

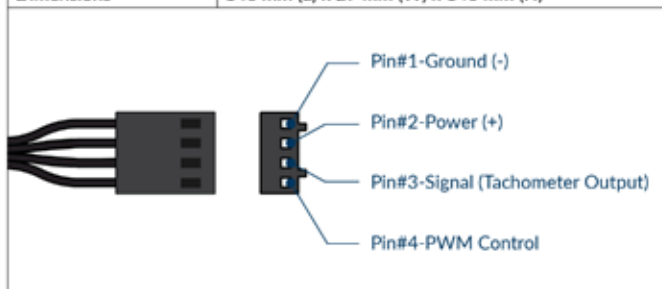

## Shipping Information

Box Dimensions	473 mm (L) x 155 mm (W) x 170 mm (H)
Gross Weight	2728 g
SKU	ACFRE00092A
EAN	4895213702812
UPC	840033400619

## Tubing

Material	Fiber Sleeved Rubber Tubing
Feature	Integrated Y-Splitter for Radiator Fans
Tube Length	450 mm
Tube Diameter	Outer 12.4 mm Inner 6.0 mm

## Radiator Specifications

Material	Aluminum
Dimensions (w/o tubes)	458 mm (L) x 138 mm (W) x 38 mm (H)

## Pump/Cold Plate

VRM-Fan	40 mm, 1000-3000 rpm (Controlled by PWM)
Pump	800-2000 rpm (Controlled by PWM)
Power Consumption	1.0 W-2.7 W (Pump and VRM Fan)
Cold Plate	Copper, Micro Skived Fin
Connector	4-Pin Connector
rpm readout	Radiator Fan only
Dimensions (w/o tubes)	78 mm (L) x 98 mm (W) x 53 mm (H)

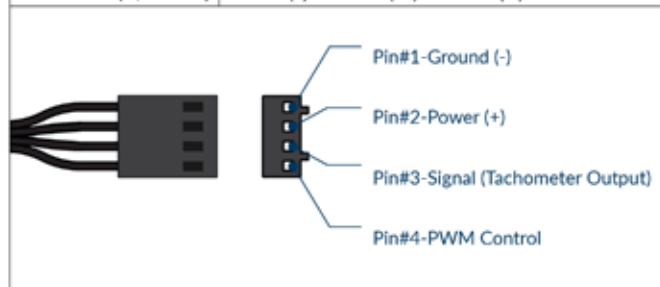

# Liquid Freezer II 420

Multi Compatible All-In-One CPU Water Cooler

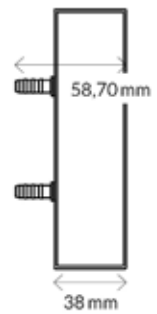
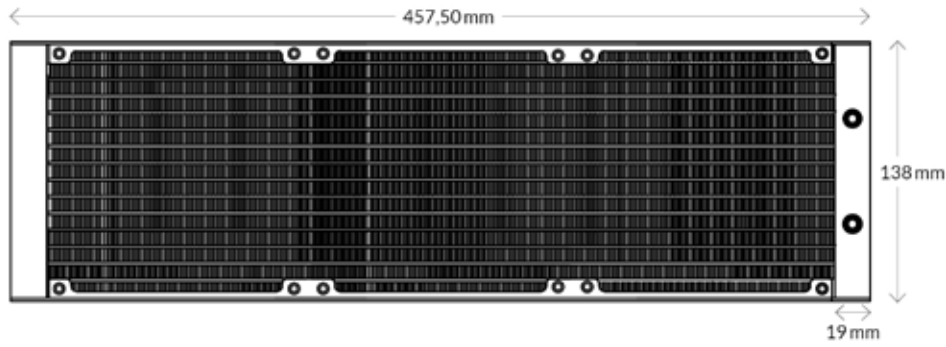
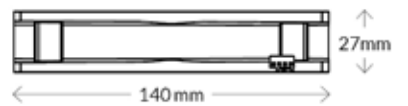
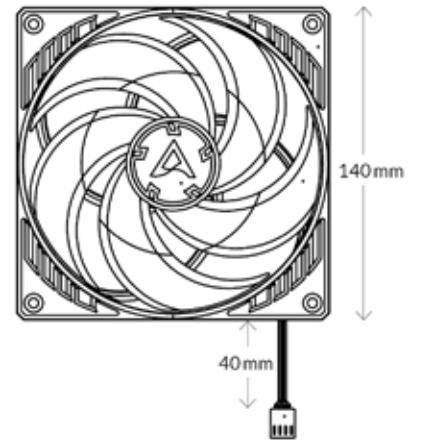
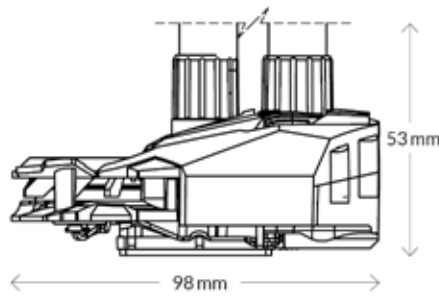
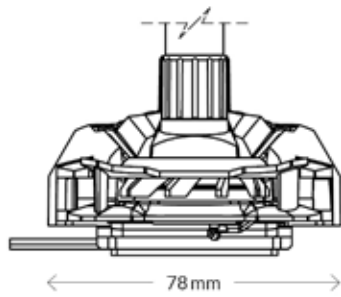
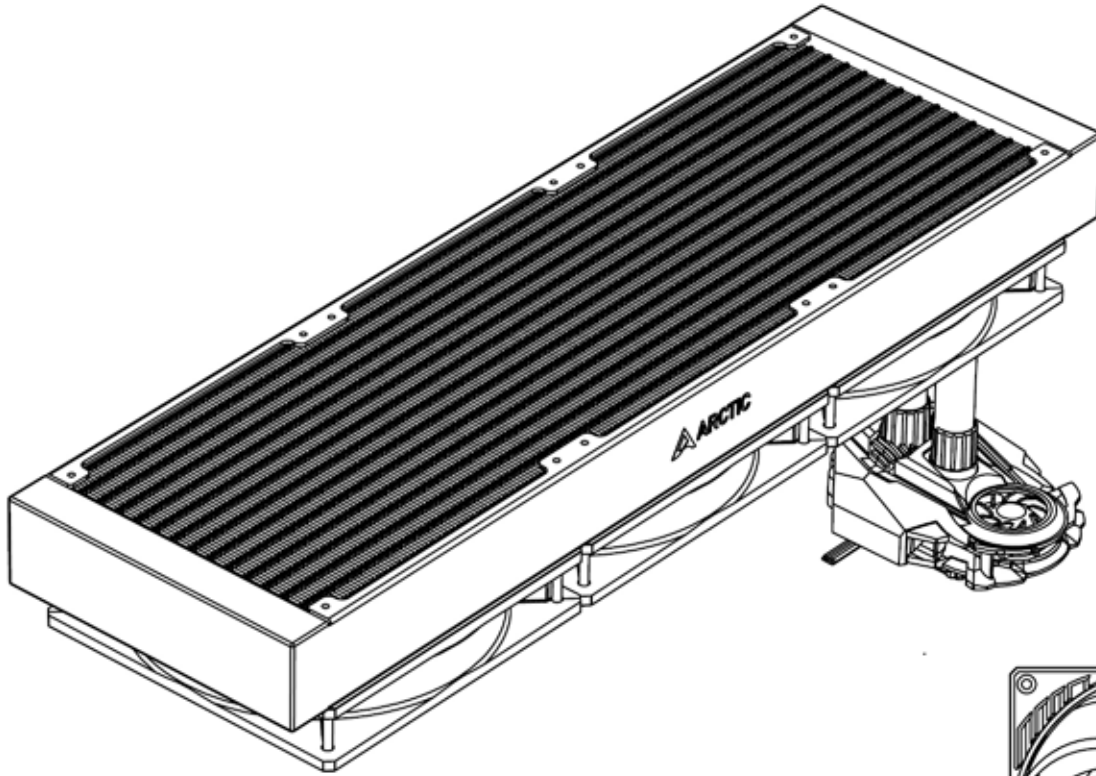

Product Information



Manual