

Dell Precision 5680

Owner's Manual

Notes, cautions, and warnings

 **NOTE:** A NOTE indicates important information that helps you make better use of your product.

 **CAUTION:** A CAUTION indicates either potential damage to hardware or loss of data and tells you how to avoid the problem.

 **WARNING:** A WARNING indicates a potential for property damage, personal injury, or death.

Chapter 1: Views of Dell Precision 5680	7
Right	7
Left	7
Top	8
Front	9
Bottom	10
Service Tag	10
Battery charge and status light	11
Chapter 2: Set up your Dell Precision 5680	12
Chapter 3: Specifications of Dell Precision 5680	14
Dimensions and weight	14
Processor	14
Chipset	15
Operating system	15
Memory	15
External ports	16
Internal slots	16
Wireless module	16
Audio	17
Storage	17
Media-card reader	18
Keyboard	18
Camera	19
Haptics trackpad	19
Power adapter	20
Battery	20
Display	21
Fingerprint reader	22
Sensor	23
GPU—Integrated	23
GPU—Discrete	23
Multiple display support matrix	23
Hardware security	24
Smart-card reader	24
Contactless smart-card reader	24
Contacted smart-card reader	26
Operating and storage environment	26
Dell Optimizer	27
Color, material, and finish	28
Chapter 4: Working inside your computer	29
Safety instructions	29

Before working inside your computer.....	29
Safety precautions.....	30
Electrostatic discharge—ESD protection.....	30
ESD field service kit	31
Transporting sensitive components.....	32
After working inside your computer.....	32
BitLocker.....	32
Recommended tools.....	32
Screw list.....	33
Major components of Dell Precision 5680.....	34

Chapter 5: Removing and installing Customer Replaceable Units (CRUs)..... 37

Secure Digital (SD) Card.....	37
Removing the SD card.....	37
Installing the SD card.....	38

Chapter 6: Removing and installing Field Replaceable Units (FRUs)..... 40

Base cover.....	40
Removing the base cover.....	40
Installing the base cover.....	43
Solid-state drive.....	45
Removing the M.2 2230 solid-state drive.....	45
Installing the M.2 2230 solid-state drive.....	46
Removing the M.2 2280 solid-state drive.....	48
Installing the M.2 2280 solid-state drive.....	48
VPU card.....	49
Removing the VPU card.....	49
Installing the VPU card.....	50
Battery.....	52
Rechargeable Li-ion battery precautions.....	52
Removing the battery.....	52
Installing the battery.....	54
System fan.....	56
Removing the left fan.....	56
Installing the left fan.....	56
Removing the right fan.....	57
Installing the right fan.....	58
Heat sink.....	59
Removing the heat sink	59
Installing the heat sink.....	61
Display assembly.....	62
Removing the display assembly.....	62
Installing the display assembly.....	65
SD-card reader daughterboard.....	68
Removing the SD-card reader daughterboard.....	68
Installing the SD-card reader daughterboard.....	69
USH and SD-card reader daughterboard.....	70
Removing the USH and SD-card reader daughterboard.....	70
Installing the USH and SD-card reader daughterboard.....	72

Smart-card reader.....	73
Removing the smart-card reader.....	73
Installing the smart-card reader.....	75
GPU card.....	77
Removing the GPU card.....	77
Installing the GPU card.....	80
Dummy GPU card.....	83
Removing the dummy GPU card.....	83
Installing the dummy GPU card.....	84
System board.....	86
Removing the system board.....	86
Installing the system board.....	92
Speakers.....	97
Removing the speakers.....	97
Installing the speakers.....	98
Haptics trackpad FPC.....	100
Removing the touchpad FPC.....	100
Installing the touchpad FPC.....	102
SD card reader daughterboard FPC.....	104
Removing the SD card reader daughterboard FPC.....	104
Installing the SD card reader daughterboard FPC.....	105
USH and SD card reader daughterboard FPC.....	106
Removing the USH and SD card reader daughterboard FPC.....	106
Installing the USH and SD card reader daughterboard FPC.....	108
Wireless Local Area Network (WLAN) Antennas.....	109
Removing the WLAN antenna module.....	109
Installing the WLAN antenna module.....	111
Power button with fingerprint reader assembly.....	113
Removing the power button with fingerprint reader assembly	113
Installing the power button with fingerprint reader assembly	114
Palm-rest assembly.....	116
Removing the palm-rest assembly.....	116
Installing the palm-rest assembly.....	117
Chapter 7: Software.....	119
Operating system.....	119
Drivers and downloads.....	119
Chapter 8: BIOS setup.....	120
Entering BIOS setup program.....	120
Navigation keys.....	120
One time boot menu.....	120
System setup options.....	121
Updating the BIOS.....	132
Updating the BIOS in Windows.....	132
Updating the BIOS in Linux and Ubuntu.....	132
Updating the BIOS using the USB drive in Windows.....	132
Updating the BIOS from the F12 One-Time boot menu.....	133
System and setup password.....	134

Assigning a system setup password.....	134
Deleting or changing an existing system setup password.....	134
Clearing BIOS (System Setup) and System passwords.....	135
Clearing Chassis Intrusion Alerts.....	135
Chapter 9: Troubleshooting.....	138
Handling swollen rechargeable Li-ion batteries.....	138
Locate the Service Tag or Express Service Code of your Dell computer	138
Dell SupportAssist Pre-boot System Performance Check diagnostics.....	139
Running the SupportAssist Pre-Boot System Performance Check.....	139
Built-in self-test (BIST).....	139
M-BIST.....	139
LCD Power rail test (L-BIST).....	140
LCD Built-in Self Test (BIST).....	140
System diagnostic lights.....	141
Recovering the operating system.....	142
Backup media and recovery options.....	142
Wi-Fi power cycle.....	142
Drain residual flea power (perform hard reset).....	142
Chapter 10: Getting help and contacting Dell.....	144

Views of Dell Precision 5680

Right



1. SD-card slot
2. USB 3.2 Gen 2 Type-C port with DisplayPort 1.4 Alt Mode
3. Wedge-shaped lock slot

Left



1. HDMI 2.0b port
2. 3.5 mm audio jack
3. Two Thunderbolt 4 (USB Type-C) ports
4. Smartcard reader (optional)

Top



1. Left and right microphones
2. Power button with fingerprint reader
3. Haptics Trackpad

Front

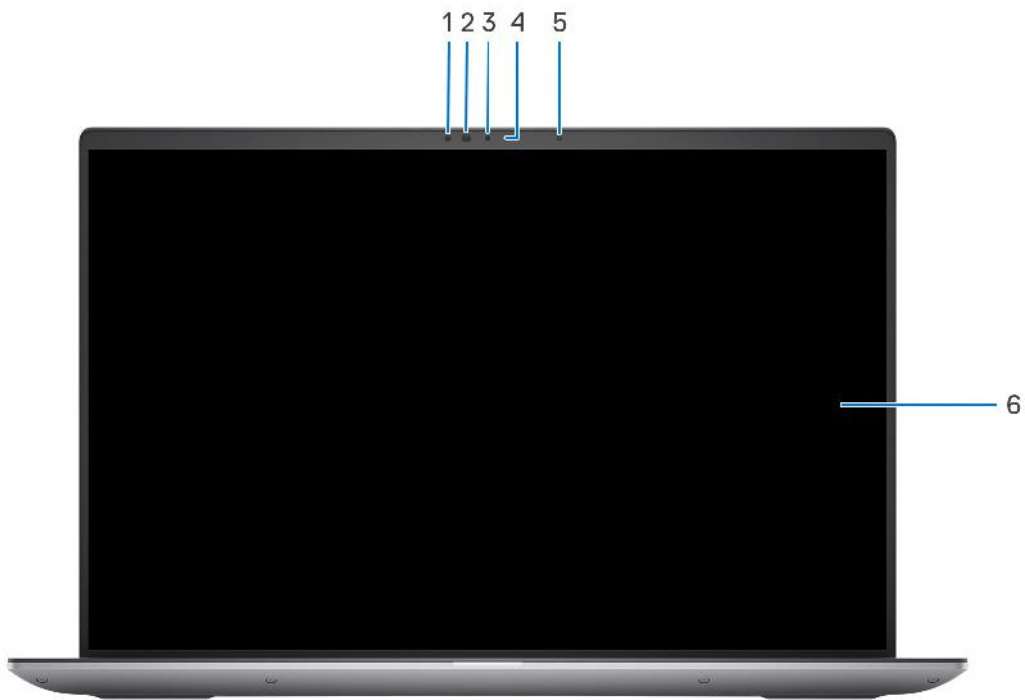

1. IR sensor
2. IR LED
3. Camera
4. Camera-status light
5. Ambient Light Sensor
6. LCD panel

Bottom

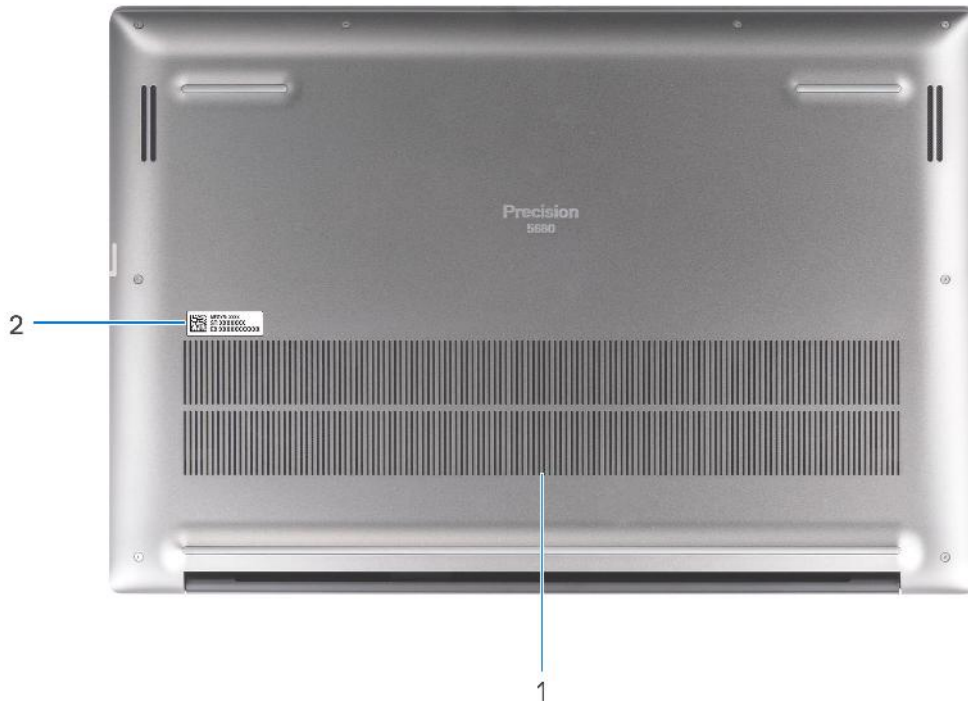

1. Air vents
2. Service Tag location

Service Tag

The service tag is a unique alphanumeric identifier that allows Dell service technicians to identify the hardware components in your computer and access warranty information.

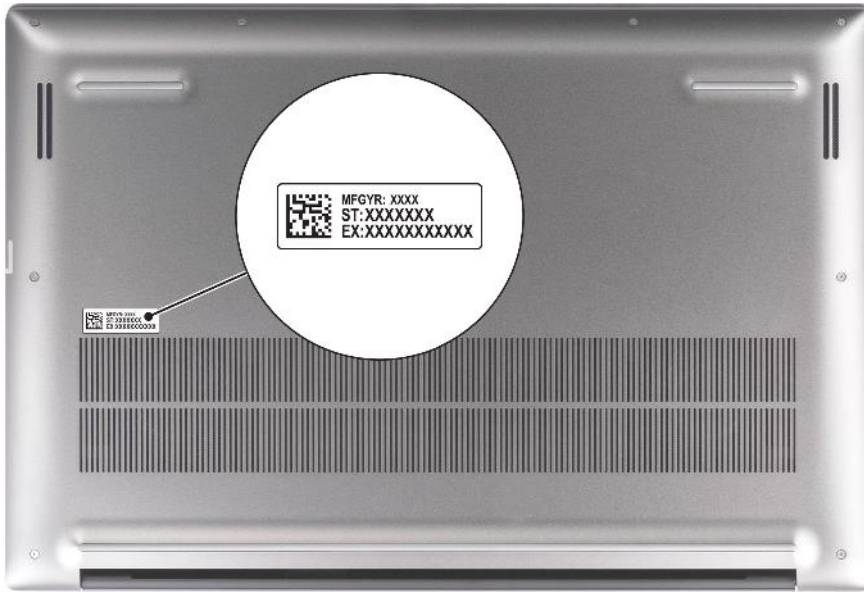

Battery charge and status light

The following table lists the battery charge and status light behavior of your Dell Precision 5680.

Table 1. Battery charge and status light behavior

Power Source	LED Behavior	System Power State	Battery Charge Level
AC Adapter	Off	S0 - S5	Fully Charged
AC Adapter	Solid White	S0 - S5	< Fully Charged
Battery	Off	S0 - S5	11-100%
Battery	Solid Amber (590+/-3 nm)	S0 - S5	< 10%

- S0 (ON) - System is turned on.
- S4 (Hibernate) - The system consumes the least power compared to all other sleep states. The system is almost at an OFF state, expect for a trickle power. The context data is written to hard drive.
- S5 (OFF) - The system is in a shutdown state.

Set up your Dell Precision 5680

About this task

NOTE: The images in this document may differ from your computer depending on the configuration you ordered.

Steps

1. Connect the power adapter and press the power button.



NOTE: To conserve battery power, the battery might enter power saving mode. Connect the power adapter and press the power button to turn on the computer.

2. Finish operating system setup.

For Ubuntu:

Follow the on-screen instructions to complete the setup. For more information about installing and configuring Ubuntu, search in the Knowledge Base Resource at www.dell.com/support.





For Windows:

Follow the on-screen instructions to complete the setup. When setting up, Dell recommends that you:

- Connect to a network for Windows updates.
 - NOTE:** If connecting to a secured wireless network, enter the password for the wireless network access when prompted.
- If connected to the internet, sign-in with or create a Microsoft account. If not connected to the internet, create an offline account.
- On the **Support and Protection** screen, enter your contact details.

3. Locate and use Dell apps from the Windows Start menu—Recommended.

Table 2. Locate Dell apps

Resources	Description
	<p>Dell Product Registration Register your computer with Dell.</p>
	<p>Dell Help & Support Access help and support for your computer.</p>
	<p>SupportAssist SupportAssist is the smart technology that keeps your computer running at its best by optimizing settings, detecting issues, removing viruses and notifies when you need to make system updates. SupportAssist proactively checks the health of your system's hardware and software. When an issue is detected, the necessary system state information is sent to Dell to begin troubleshooting. SupportAssist is preinstalled on most of the Dell devices running Windows operating system. For more information, see SupportAssist for Home PCs User's Guide on www.dell.com/serviceabilitytools.</p> <p>NOTE: In SupportAssist, click the warranty expiry date to renew or upgrade your warranty.</p>
	<p>Dell Update Updates your computer with critical fixes and latest device drivers as they become available. For more information on using Dell Update, search in the Knowledge Base Resource at www.dell.com/support.</p>
	<p>Dell Digital Delivery Download software applications, which are purchased but not preinstalled on your computer. For more information on using Dell Digital Delivery, search in the Knowledge Base Resource at www.dell.com/support.</p>

Specifications of Dell Precision 5680

Dimensions and weight

The following table lists the height, width, depth, and weight of your Dell Precision 5680.

Table 3. Dimensions and weight

Description	Values
Height:	
Front height	26.17 mm (1.03 in.)
Rear height	26.17 mm (1.03 in.)
Width	353.68 mm (13.92 in.)
Depth	240.27 mm (9.45 in.)
Weight  NOTE: The weight of your computer depends on the configuration ordered and manufacturing variability.	1.905 kg (4.20 lb)

Processor

The following table lists the details of the processors supported by your Dell Precision 5680.

Table 4. Processor

Description	Option one	Option two	Option three	Option four
Processor type	13 th Generation Intel Core i5-13600H vPro Enterprise	13 th Generation Intel Core i7-13700H vPro Essential	13 th Generation Intel Core i7-13800H vPro Enterprise	13 th Generation Intel Core i9-13900H vPro Enterprise
Processor wattage	45 W	45 W	45 W	45 W
Processor core count	12	14	14	14
Processor thread count	16	20	20	20
Processor speed	Up to 4.80 GHz	Up to 5.0 GHz	Up to 5.2 GHz	Up to 5.4 GHz
Processor cache	18 MB	24 MB	24 MB	24 MB
Integrated graphics	Intel Iris X ^e Graphics	Intel Iris X ^e Graphics	Intel Iris X ^e Graphics	Intel Iris X ^e Graphics

Chipset

The following table lists the details of the chipset supported by your Dell Precision 5680.

Table 5. Chipset

Description	Values
Chipset	Intel PCH
Processor	13 th Generation Intel Core i5/i7/i9
DRAM bus width	128-bit
Flash EPROM	64 MB
PCIe bus	Up to Gen 4.0

Operating system

Your Dell Precision 5680 supports the following operating systems:

- Windows 11 Home, 64-bit
- Windows 11 Pro, 64-bit
- Windows 11 Pro for Workstation, 64-bit
- Windows 11 Pro for Education, 64-bit
- Windows 11 Enterprise, 64-bit
- Ubuntu 22.04 LTS, 64-bit

Memory

The following table lists the memory specifications of your Dell Precision 5680.

Table 6. Memory specifications

Description	Values
Memory slots	Integrated on system board  NOTE: The memory is not replaceable or upgradeable. If memory has error, the system board must be replaced.
Memory type	Dual-channel LPDDR5
Memory speed	6400 MT/s or 6000 MT/s
Maximum memory configuration	64 GB
Minimum memory configuration	16 GB
Memory size per slot	16 GB, 32 GB, 64 GB
Memory configurations supported	<ul style="list-style-type: none">• 16 GB LPDDR5 at 6400 MT/s, integrated, dual channel• 32 GB LPDDR5 at 6000 MT/s, integrated, dual channel• 64 GB LPDDR5 at 6000 MT/s, integrated, dual channel

External ports

The following table lists the external ports on your Dell Precision 5680.

Table 7. External ports

Description	Values
USB ports	<ul style="list-style-type: none"> One USB 3.2 Gen 2 Type-C port with DisplayPort 1.4 Alt Mode Two Thunderbolt 4 ports (USB Type-C)
Audio port	One 3.5 mm audio jack
Video port/ports	One HDMI 2.0b port
Media-card reader	One SD-card slot
Power-adapter port	Two Thunderbolt 4 ports (USB Type-C)
Security-cable slot	One wedge-shaped lock slot

Internal slots

The following table lists the internal slots of your Dell Precision 5680.

Table 8. Internal slots

Description	Values
M.2	<ul style="list-style-type: none"> Two M.2 2230/2280 slot for solid-state drive/Intel Optane <p>NOTE: To learn more about the features of different types of M.2 cards, search in the Knowledge Base Resource at www.dell.com/support.</p>

Wireless module

The following table lists the Wireless Local Area Network (WLAN) module that is supported on your Dell Precision 5680.

Table 9. Wireless module specifications

Description	Values
Model number	Intel AX211
Transfer rate	Up to 2400 Mbps
Frequency bands supported	2.4 GHz/5 GHz/6 GHz
Wireless standards	<ul style="list-style-type: none"> Wi-Fi 802.11a/b/g Wi-Fi 4 (WiFi 802.11n) Wi-Fi 5 (WiFi 802.11ac) Wi-Fi 6E (WiFi 802.11ax)
Encryption	<ul style="list-style-type: none"> 64-bit/128-bit WEP AES-CCMP TKIP

Table 9. Wireless module specifications (continued)

Description	Values
Bluetooth wireless card	Bluetooth 5.3
	i NOTE: The version of the Bluetooth wireless card may vary depending on the operating system that is installed on your computer.

Audio

The following table lists the audio specifications of your Dell Precision 5680.

Table 10. Audio specifications

Description	Values
Audio controller	Realtek ALC711-VD
Stereo conversion	Supported
Internal audio interface	High definition audio interface
External audio interface	One 3.5 mm audio jack
Number of speakers	<ul style="list-style-type: none"> 2 x Woofers 2 x Tweeters
Internal-speaker amplifier	Supported
External volume controls	Keyboard shortcut controls
Speaker output:	
Average speaker output	<ul style="list-style-type: none"> Woofers: 2 x 2 W Tweeters: 2 x 2 W
Peak speaker output	<ul style="list-style-type: none"> Woofers: 2 x 2.5 W Tweeters: 2 x 2.5 W
Subwoofer output	Supported
Microphone	Dual-array microphones in camera assembly

Storage

This section lists the storage options on your Dell Precision 5680.

Your Precision 5680 supports one of the following storage configurations:

- 2 x M.2 2230/M.2 2280, solid-state drive
- 2 x M.2 2280, Opal Self-Encrypting solid-state drive

The primary drive of your computer varies with the storage configuration.

Table 11. Storage specifications

Storage type	Interface type	Capacity
M.2 2230, Class 35 solid-state drive	PCIe NVMe Gen 4	256 GB

Table 11. Storage specifications (continued)

Storage type	Interface type	Capacity
M.2 2280, Class 40 solid-state drive	PCIe NVMe Gen 4	Up to 4 TB
M.2 2280, Class 40 solid-state drive, Opal Self-Encrypting solid-state drive	PCIe NVMe Gen 4	Up to 1 TB

Media-card reader

The following table lists the media cards supported by your Dell Precision 5680.

Table 12. Media-card reader specifications

Description	Values
Media-card type	One SD card slot
Media-cards supported	<ul style="list-style-type: none"> Secure Digital (SD) Secure Digital High Capacity (SDHC) Secure Digital Extended Capacity (SDXC)
<p> NOTE: The maximum capacity supported by the media-card reader varies depending on the standard of the media card installed in your computer.</p>	

Keyboard

The following table lists the keyboard specifications of your Dell Precision 5680.

Table 13. Keyboard specifications

Description	Values
Keyboard type	Backlit keyboard
Keyboard layout	QWERTY
Number of keys	<ul style="list-style-type: none"> United States and Canada: 79 keys United Kingdom: 80 keys Japan: 83 keys
Keyboard size	X=19.05 mm key pitch Y=18.05 mm key pitch
Keyboard shortcuts	<p>Some keys on your keyboard have two symbols on them. These keys can be used to type alternate characters or to perform secondary functions. To type the alternate character, press Shift and the desired key. To perform secondary functions, press Fn and the desired key.</p> <p> NOTE: You can define the primary behavior of the function keys (F1–F12) changing Function Key Behavior in BIOS setup program.</p>

Camera

The following table lists the camera specifications of your Dell Precision 5680.

Table 14. Camera specifications

Description		Values
Number of cameras		One
Camera type		FHD IR camera with narrow FHD+IR w/ XYZ ALS (MIPI), Dual-array microphones
Camera location		Front camera
Camera sensor type		Intel Camera Sensing Technology (ExpressSign-in 2.0)
Camera resolution:		
	Still image	0.90 megapixel
	Video	1920 x 1080 FHD at 30 fps
Infrared camera resolution:		
	Still image	0.23 megapixel
	Video	640 x 360 at 15 fps
Diagonal viewing angle:		
	Camera	78 degrees
	Infrared camera	78 degrees

Haptics trackpad

The following table lists the touchpad specifications of your Dell Precision 5680.

Table 15. Touchpad specifications

Description		Values
Touchpad resolution:		300 dpi
Touchpad dimensions:		
	Horizontal	136 mm (5.35 in.)
	Vertical	85 mm (3.34 in.)
Touchpad gestures		For more information about touchpad gestures available on Windows, see the Microsoft knowledge base article at support.microsoft.com .

Power adapter

The following table lists the power adapter specifications of your Dell Precision 5680.

Table 16. Power adapter specifications

Description	Option one	Option two
Type	100 W Pecos AC adapter, USB-C	165 W ERP AC adapter, USB-C
Input voltage	100 VAC—240 VAC	100 VAC—240 VAC
Input frequency	50 Hz-60 Hz	50 Hz–60 Hz
Input current (maximum)	1.7 A	2.2 A
Output current (continuous)	<ul style="list-style-type: none"> ● 20 V/5 A ● 15 V/3 A ● 9 V/3 A ● 5 V/3 A 	<ul style="list-style-type: none"> ● 28 V/5.893 A ● 20 V/6.5 A ● 15 V/3 A ● 9 V/3 A ● 5 V/3 A
Rated output voltage	20 VDC/15 VDC/9 VDC/5 VDC	5 VDC/9 VDC/15 VDC/20 VDC/28 VDC
Temperature range:		
Operating	0 °C to 40 °C (32 °F to 104 °F)	0 °C to 40 °C (32 °F to 104 °F)
Storage	-40 °C to 70 °C (-40 °F 158 °F)	-40 °C to 70 °C (-40 °F 158 °F)
 CAUTION: Operating and storage temperature ranges may differ among components, so operating or storing the device outside these ranges may impact the performance of specific components.		

Battery

The following table lists the battery specifications of your Dell Precision 5680.

Table 17. Battery specifications

Description	Option one	Option two	Option three	Option four
Battery type	4-cell, 66 Whr lithium-ion battery	6-cell, 99.5 Whr lithium-ion battery	4-cell 66 Whr lithium-ion LcL battery	6-cell 99.5 Whr lithium-ion LcL battery
Battery voltage	15.4 VDC (Nominal)	11.55 VDC (Nominal)	15.4 VDC (Nominal)	11.55 VDC (Nominal)
Battery weight (maximum)	0.264 kg (0.58 lb)	0.363 kg (0.8 lb)	0.264 kg (0.58 lb)	0.363 kg (0.8 lb)
Battery dimensions:				
Height	7.66 mm (0.30 in.)	7.66 mm (0.30 in.)	7.66 mm (0.30 in.)	7.66 mm (0.30 in.)
Width	302 mm (11.89 in.)	302 mm (11.89 in.)	302 mm (11.89 in.)	302 mm (11.89 in.)
Depth	85.4 mm (3.36 in.)	85.4 mm (3.36 in.)	85.4 mm (3.36 in.)	85.4 mm (3.36 in.)
Temperature range:				

Table 17. Battery specifications (continued)

Description		Option one	Option two	Option three	Option four
	Operating	<ul style="list-style-type: none"> Charge: 0°C to 50°C (32°F to 122°F) Discharge: 0°C to 60°C (32°F to 140°F) 	<ul style="list-style-type: none"> Charge: 0°C to 50°C (32°F to 122°F) Discharge: 0°C to 60°C (32°F to 140°F) 	<ul style="list-style-type: none"> Charge: 0°C to 50°C (32°F to 122°F) Discharge: 0°C to 60°C (32°F to 140°F) 	<ul style="list-style-type: none"> Charge: 0°C to 50°C (32°F to 122°F) Discharge: 0°C to 60°C (32°F to 140°F)
	Storage	-20°C to 65°C (-4°F to 149°F)	-20°C to 65°C (-4°F to 149°F)	-20°C to 65°C (-4°F to 149°F)	-20°C to 65°C (-4°F to 149°F)
Battery operating time		Varies depending on operating conditions and can significantly reduce under certain power-intensive conditions.	Varies depending on operating conditions and can significantly reduce under certain power-intensive conditions.	Varies depending on operating conditions and can significantly reduce under certain power-intensive conditions.	Varies depending on operating conditions and can significantly reduce under certain power-intensive conditions.
Battery charging time (approximate) ⓘ NOTE: Control the charging time, duration, start and end time, and so on using the Dell Power Manager application. For more information on the Dell Power Manager see, <i>Me and My Dell</i> on www.dell.com .		<ul style="list-style-type: none"> From 0% up to 35% in as little as 20 minutes (ExpressCharge Boost) 2 hours (Express charge) 3 hours (Standard charge) 	<ul style="list-style-type: none"> From 0% up to 35% in as little as 20 minutes (ExpressCharge Boost) 2 hours (Express charge) 3 hours (Standard charge) 	<ul style="list-style-type: none"> 2 hours (Express charge) 3 hours (Standard charge) 	<ul style="list-style-type: none"> 2 hours (Express charge) 3 hours (Standard charge)
Coin-cell battery		No	No	No	No
<p>⚠ CAUTION: Operating and storage temperature ranges may differ among components, so operating or storing the device outside these ranges may impact the performance of specific components.</p> <p>⚠ CAUTION: Dell recommends that you charge the battery regularly for optimal power consumption. If your battery charge is completely depleted, connect the power adapter, turn on your computer, and then restart your computer to reduce the power consumption.</p>					

Display

The following table lists the display specifications of your Dell Precision 5680.

Table 18. Display specifications

Description	Option one	Option two
Display type	16-inch, FHD+, non-touch, 60Hz, anti-glare, 500 nits WLED, Low Blue Light	16-inch OLED, touch, 60Hz, anti-smudge, 400 nits WLED
Touch options	No	Yes
Display-panel technology	WLED with Low Blue Light	OLED with Low Blue Light
Display-panel dimensions (active area):		

Table 18. Display specifications (continued)

Description		Option one	Option two
	Height	22.17 mm (0.87 in.)	22.17 mm (0.87 in.)
	Width	344.68 mm (13.57 in.)	344.45 mm (13.56 in.)
	Diagonal	406.4 mm (16 in.)	406.4 mm (16 in.)
Display-panel native resolution		1920 x 1200	3840 x 2400
Luminance (typical)		500 nits	400 nits
Megapixels		2.3	9.2
Color gamut		DCI-P3 100%	DCI-P3 100%
Pixels Per Inch (PPI)		142	283
Contrast ratio (min.)		1300:1	100000:1
Response time (max.)		30 ms	1 ms typ.
Refresh rate		60 Hz	60 Hz
Horizontal view angle		+/- 85 degrees	+/- 85 degrees typical
Vertical view angle		+/- 85 degrees	+/- 85 degrees typical
Pixel pitch		0.18 mm	0.09 mm
Power consumption (maximum)		6.32 W	11.14 W
Anti-glare vs glossy finish		Anti-glare	Anti-smudge

Fingerprint reader

The following table lists the fingerprint-reader specifications of your Dell Precision 5680.

NOTE: The fingerprint reader is located on the power button.

Table 19. Fingerprint reader specifications

Description	Values
Fingerprint-reader sensor technology	Capacitive
Fingerprint-reader sensor resolution	500 dpi
Fingerprint-reader sensor pixel size	108 x 88

Sensor

The following table lists the sensor of your Dell Precision 5680.

Table 20. Sensor

Sensor support
Accelerometer for adaptive thermal

GPU—Integrated

The following table lists the specifications of the integrated Graphics Processing Unit (GPU) supported by your Dell Precision 5680.

Table 21. GPU—Integrated

Controller	Memory size	Processor
Intel Iris X ^e Graphics	Shared system memory	13 th Generation Intel Core i5/i7/i9 processors

GPU—Discrete

The following table lists the specifications of the discrete Graphics Processing Unit (GPU) supported by your Dell Precision 5680.

Table 22. GPU—Discrete

Controller	Memory size
NVIDIA RTX A1000 6GB Laptop GPU	6 GB
NVIDIA RTX 2000 Ada Generation Laptop GPU	8 GB
NVIDIA RTX 3500 Ada Generation Laptop GPU	12 GB
NVIDIA RTX 4000 Ada Generation Laptop GPU	12 GB
NVIDIA RTX 5000 Ada Generation Laptop GPU	16 GB
NVIDIA GeForce RTX 4090 Laptop GPU	16 GB

Multiple display support matrix

The following table lists the multiple display support matrix for your Dell Precision 5680.

Table 23. Multiple display support matrix

Graphics Card	Supported external displays
Intel Iris X ^e Graphics	Yes, supported on USB-C, TBT and HDMI port.
NVIDIA RTX A1000 6GB Laptop GPU	Yes, supported on the right side USB-C port only.
NVIDIA RTX 2000 Ada Generation Laptop GPU	Yes, supported on the right side USB-C port only.
NVIDIA RTX 3500 Ada Generation Laptop GPU	Yes, supported on the right side USB-C port only.
NVIDIA RTX 4000 Ada Generation Laptop GPU	Yes, supported on the right side USB-C port only.
NVIDIA RTX 5000 Ada Generation Laptop GPU	Yes, supported on the right side USB-C port only.

Table 23. Multiple display support matrix (continued)

Graphics Card	Supported external displays
NVIDIA GeForce RTX 4090 Laptop GPU	Yes, supported on the right side USB-C port only.

Hardware security

The following table lists the hardware security of your Dell Precision 5680.

Table 24. Hardware security

Hardware security
Hardware TPM 2.0 discrete
Wedge-shaped lock slot
FIPS 140-2 certification for TPM
TCG Certification for TPM (Trusted Computing Group)
ControlVault 3 Advanced Authentication with FIPS 140-2 Level 3 Certification
Contacted Smart Card and Control Vault 3
Contactless Smart Card, NFC, and Control Vault 3
Statement of Non-Volatility

Smart-card reader

Contactless smart-card reader

This section lists the contactless smart-card reader specifications of your Dell Precision 5680.

Table 25. Contactless smart-card reader specifications

Title	Description	Dell ControlVault 3 contactless smart-card reader with NFC
Felica Card Support	Reader and software capable of supporting Felica contactless cards	Yes
ISO 14443 Type A Card Support	Reader and software capable of supporting ISO 14443 Type A contactless cards	Yes
ISO 14443 Type B Card Support	Reader and software capable of supporting ISO 14443 Type B contactless cards	Yes
ISO/IEC 21481	Reader and software capable of supporting ISO/IEC 21481 compliant contactless cards and tokens	Yes
ISO/IEC 18092	Reader and software capable of supporting ISO/IEC 21481 compliant contactless cards and tokens	Yes
ISO 15693 Card Support	Reader and software capable of supporting ISO15693 contactless cards	Yes
NFC Tag Support	Supports reading and processing of NFC compliant tag information	Yes

Table 25. Contactless smart-card reader specifications (continued)

Title	Description	Dell ControlVault 3 contactless smart-card reader with NFC
NFC Reader Mode	Support for NFC Forum Defined Reader mode	Yes
NFC Writer Mode	Support for NFC Forum Defined Writer mode	Yes
NFC Peer-to-Peer Mode	Support for NFC Forum Defined Peer to Peer mode	Yes
EMVCo Compliant	Compliant with EMVCO smart card standards as posted to www.emvco.com	Yes
EMVCo Certified	Formally certified based on EMVCO smart card standards	Yes
NFC Proximity OS Interface	Enumerates NFP (Near Field Proximity) device for OS to utilize	Yes
PC/SC OS interface	Personal Computer/Smart Card specification for integration of hardware readers into personal computer environments	Yes
CCID driver compliance	Common driver support for Integrated Circuit Card Interface Device for OS level drivers	Yes
Windows Certified	Device certified by Microsoft WHCK	Yes
Dell ControlVault support	Device connects to Dell ControlVault for usage and processing	Yes
FIDO2 compliance	Dell ControlVault 3 Smart-card reader is compliant with the FIDO SPEC	Yes

 **NOTE:** 125 Khz proximity cards are not supported.

Table 26. Supported cards

Manufacturer	Card
HID	jCOP readertest3 A card (14443a)
	1430 1L
	DESFire D8H
	iClass (Legacy)
	iClass SEOS
NXP/Mifare	Mifare DESFire 8K White PVC Cards
	Mifare Classic 1K White PVC Cards
	NXP Mifare Classic S50 ISO Card
G&D	idOnDemand - SCE3.2 144K
	SCE6.0 FIPS 80K Dual+ 1 K Mifare
	SCE6.0 nonFIPS 80K Dual+ 1 K Mifare
	SCE6.0 FIPS 144K Dual + 1K Mifare
	SCE6.0 nonFIPS 144K Dual + 1 K Mifare
	SCE7.0 FIPS 144K

Table 26. Supported cards (continued)

Manufacturer	Card
Oberthur	idOnDemand - OCS5.2 80K
	ID-One Cosmo 64 RSA D V5.4 T=0 card

Contacted smart-card reader

The following table lists the contacted smart-card reader specifications of your Dell Precision 5680.

Table 27. Contacted smart-card reader specifications

Title	Description	Dell ControlVault 3 smart-card reader
ISO 7816 -3 Class A Card Support	Reader capable of reading 5V powered smart mcard	Yes
ISO 7816 -3 Class B Card Support	Reader capable of reading 3V powered smart card	Yes
ISO 7816 -3 Class C Card support	Reader capable of reading 1.8V powered smart card	Yes
ISO 7816-1 Compliant	Specification for the reader	Yes
ISO 7816 -2 Compliant	Specification for smart card device physical characteristics (size, location of connection points, etc.)	Yes
T=0 support	Cards support character level transmission	Yes
T=1 support	Cards support block level transmission	Yes
EMVCo Compliant	Compliant with EMVCo (for electronic payment standards) smart card standards as posted to www.emvco.com	Yes
EMVCo Certified	Formally certified based on EMVCO smart card standards	Yes
PC/SC OS interface	Personal Computer/Smart Card specification for integration of hardware readers into personal computer environments	Yes
CCID driver compliance	Common driver support for Integrated Circuit Card Interface Device for OS level drivers.	Yes
Windows Certified	Device certified by WHCK	Yes
FIPS 201 (PIV/HSPD-12) Compliant via GSA	Device compliant with FIPS 201/PIV/HSPD-12 requirements	Yes
FIDO2 compliance	Dell ControlVault 3 Smart-card reader is compliant with the FIDO SPEC	Yes

Operating and storage environment

This table lists the operating and storage specifications of your Dell Precision 5680.

Airborne contaminant level: G1 as defined by ISA-S71.04-1985

Table 28. Computer environment

Description	Operating	Storage
Temperature range	0°C to 35°C (32°F to 95°F)	-40°C to 65°C (-40°F to 149°F)
Relative humidity (maximum)	10% to 90% (non-condensing)	0% to 95% (non-condensing)
Vibration (maximum)*	0.66 GRMS	1.30 GRMS
Shock (maximum)	110 G†	160 G†
Altitude range	-15.2 m to 3048 m (-49.87 ft to 10000 ft)	-15.2 m to 10668 m (-49.87 ft to 35000 ft)
 CAUTION: Operating and storage temperature ranges may differ among components, so operating or storing the device outside these ranges may impact the performance of specific components.		

* Measured using a random vibration spectrum that simulates user environment.

† Measured using a 2 ms half-sine pulse.

Dell Optimizer

This section details the Dell Optimizer specifications of your Dell Precision 5680.

Dell Optimizer is a software application that intelligently optimizes the performance of your system by using artificial intelligence and machine learning. Dell Optimizer dynamically configures your system settings to optimize the performance of your applications. It improves the productivity, performance, and user experience through system usage analysis and learning.

On Dell Precision 5680 with Dell Optimizer, the following features are supported:

- Improves user experience through computer usage analysis and learning
- Faster application launch and seamless application transition
- Intelligent battery run-time extension
- Optimized Audio for best meeting experience
- Locks computer when walks away for enhanced security
- Faster computer wake-on-user approach
- Intelligently shows alerts
- Updates automatically to minimize disruption

For more information about configuring and using these features, refer [Dell Optimizer documentation](#).

Color, material, and finish

This section details the color, material, and finish (CMF) specifications of your Dell Precision 5680.



Table 29. CMF specifications

A Cover (Top)	<ul style="list-style-type: none"> Aluminum/Extrusion + CNC + Insert Molded + Beadblast Anodized Titan Gray PMS Cool Gray 9C
B Cover (Hinge up)	<ul style="list-style-type: none"> PC UV Molding +CNC + Back Printing Match to Apollo
C Cover (Palmrest)	<ul style="list-style-type: none"> Plastic PC 50%GFC Bonded MgAl Frame + CNC Drilled speaker Holes Dell Standard Black, Resin PMS 19-4205 TPG Apollo, Velvet
D Cover (Bottom)	<ul style="list-style-type: none"> Aluminum/Extrusion + CNC + Insert Molded + Beadblast Anodized Titan Gray PMS Cool Gray 9C











NOTE: Titan Gray, Dull – Cool Gray 9C = RGB 117 120 123 HEX/HTML 75787B CMYK 30 22 17 57

NOTE: Apollo –19-4205 TPG RGB 64 65 69 HEX/HTML 404145 CMYK NA

Working inside your computer



Safety instructions

Use the following safety guidelines to protect your computer from potential damage and to ensure your personal safety. Unless otherwise noted, each procedure included in this document assumes that you have read the safety information that shipped with your computer.

-  **WARNING:** Before working inside your computer, read the safety information that is shipped with your computer. For more safety best practices, see the Regulatory Compliance home page at www.dell.com/regulatory_compliance.
-  **WARNING:** Disconnect your computer from all power sources before opening the computer cover or panels. After you finish working inside the computer, replace all covers, panels, and screws before connecting your computer to an electrical outlet.
-  **CAUTION:** To avoid damaging the computer, ensure that the work surface is flat, dry, and clean.
-  **CAUTION:** To avoid damaging the components and cards, handle them by their edges, and avoid touching the pins and the contacts.
-  **CAUTION:** You should only perform troubleshooting and repairs as authorized or directed by the Dell technical assistance team. Damage due to servicing that is not authorized by Dell is not covered by your warranty. See the safety instructions that is shipped with the product or at www.dell.com/regulatory_compliance.
-  **CAUTION:** Before touching anything inside your computer, ground yourself by touching an unpainted metal surface, such as the metal at the back of the computer. While you work, periodically touch an unpainted metal surface to dissipate static electricity which could harm internal components.
-  **CAUTION:** When you disconnect a cable, pull it by its connector or its pull tab, not the cable itself. Some cables have connectors with locking tabs or thumbscrews that you must disengage before disconnecting the cable. When disconnecting cables, keep them evenly aligned to avoid bending the connector pins. When connecting cables, ensure that the ports and the connectors are correctly oriented and aligned.
-  **CAUTION:** Press and eject any installed card from the media-card reader.
-  **CAUTION:** Exercise caution when handling rechargeable Li-ion batteries in laptops. Swollen batteries should not be used and should be replaced and disposed properly.
-  **NOTE:** The color of your computer and certain components may appear differently than shown in this document.

Before working inside your computer

Steps

1. Save and close all open files and exit all open applications.
2. Shut down your computer. For Windows operating system, click **Start** >  **Power** > **Shut down**.
 -  **NOTE:** If you are using a different operating system, see the documentation of your operating system for shut-down instructions.
3. Disconnect your computer and all attached devices from their electrical outlets.
4. Disconnect all attached network devices and peripherals, such as keyboard, mouse, and monitor from your computer.

5. Remove any media card and optical disk from your computer, if applicable.
6. Enter the service mode, if you are able to power on your computer.

Service Mode

Service Mode is used to cut-off power, without disconnecting battery cable from system board prior conducting repairs in the computer.

CAUTION: If you are unable to turn on the computer to put it into Service Mode or the computer does not support Service Mode then proceed to disconnect the battery cable. To disconnect the battery cable, follow the steps in [Removing the battery](#).

NOTE: Ensure that your computer is shut down and the AC adapter is disconnected.

- a. Hold **** key on the keyboard and press the power button for 3 seconds or until the Dell logo appears on the screen.
- b. Press any key to continue.
- c. If the AC adapter is not disconnected, a message prompting you to remove the AC adapter appears on the screen. Remove the AC adapter and then press any key to continue the **Service Mode** procedure. The **Service Mode** procedure automatically skips the following step if the **Owner Tag** of the computer is not set up in advance by the user.
- d. When the ready-to-proceed message appears on the screen, press any key to proceed. The computer emits three short beeps and shuts down immediately.
- e. Once the computer shuts down, it has successfully entered Service Mode.

NOTE: If you are unable to power on your computer or unable to enter service mode skip this process.

Safety precautions

The safety precautions chapter details the primary steps to be taken before performing any disassembly instructions.

Observe the following safety precautions before you perform any installation or break/fix procedures involving disassembly or reassembly:

- Turn off the system and all attached peripherals.
- Disconnect the system and all attached peripherals from AC power.
- Disconnect all network cables, telephone, and telecommunications lines from the system.
- Use an ESD field service kit when working inside any notebook to avoid electrostatic discharge (ESD) damage.
- After removing any system component, carefully place the removed component on an anti-static mat.
- Wear shoes with non-conductive rubber soles to reduce the chance of getting electrocuted.

Standby power

Dell products with standby power must be unplugged before you open the case. Systems that incorporate standby power are essentially powered while turned off. The internal power enables the system to be remotely turned on (wake on LAN) and suspended into a sleep mode and has other advanced power management features.

Unplugging, pressing, and holding the power button for 15 seconds should discharge residual power in the system board.

Bonding

Bonding is a method for connecting two or more grounding conductors to the same electrical potential. This is done through the use of a field service electrostatic discharge (ESD) kit. When connecting a bonding wire, ensure that it is connected to bare metal and never to a painted or non-metal surface. The wrist strap should be secure and in full contact with your skin, and ensure that you remove all jewelry such as watches, bracelets, or rings prior to bonding yourself and the equipment.

Electrostatic discharge—ESD protection

ESD is a major concern when you handle electronic components, especially sensitive components such as expansion cards, processors, memory DIMMs, and system boards. Very slight charges can damage circuits in ways that may not be obvious, such as intermittent problems or a shortened product life span. As the industry pushes for lower power requirements and increased density, ESD protection is an increasing concern.

Due to the increased density of semiconductors used in recent Dell products, the sensitivity to static damage is now higher than in previous Dell products. For this reason, some previously approved methods of handling parts are no longer applicable.

Two recognized types of ESD damage are catastrophic and intermittent failures.

- **Catastrophic** – Catastrophic failures represent approximately 20 percent of ESD-related failures. The damage causes an immediate and complete loss of device functionality. An example of catastrophic failure is a memory DIMM that has received a static shock and immediately generates a "No POST/No Video" symptom with a beep code emitted for missing or nonfunctional memory.
- **Intermittent** – Intermittent failures represent approximately 80 percent of ESD-related failures. The high rate of intermittent failures means that most of the time when damage occurs, it is not immediately recognizable. The DIMM receives a static shock, but the tracing is merely weakened and does not immediately produce outward symptoms related to the damage. The weakened trace may take weeks or months to melt, and in the meantime may cause degradation of memory integrity, intermittent memory errors, etc.

The more difficult type of damage to recognize and troubleshoot is the intermittent (also called latent or "walking wounded") failure.

Perform the following steps to prevent ESD damage:

- Use a wired ESD wrist strap that is properly grounded. The use of wireless anti-static straps is no longer allowed; they do not provide adequate protection. Touching the chassis before handling parts does not ensure adequate ESD protection on parts with increased sensitivity to ESD damage.
- Handle all static-sensitive components in a static-safe area. If possible, use anti-static floor pads and workbench pads.
- When unpacking a static-sensitive component from its shipping carton, do not remove the component from the anti-static packing material until you are ready to install the component. Before unwrapping the anti-static packaging, ensure that you discharge static electricity from your body.
- Before transporting a static-sensitive component, place it in an anti-static container or packaging.

ESD field service kit

The unmonitored Field Service kit is the most commonly used service kit. Each Field Service kit includes three main components: anti-static mat, wrist strap, and bonding wire.

Components of an ESD field service kit

The components of an ESD field service kit are:

- **Anti-Static Mat** – The anti-static mat is dissipative and parts can be placed on it during service procedures. When using an anti-static mat, your wrist strap should be snug and the bonding wire should be connected to the mat and to any bare metal on the system being worked on. Once deployed properly, service parts can be removed from the ESD bag and placed directly on the mat. ESD-sensitive items are safe in your hand, on the ESD mat, in the system, or inside a bag.
- **Wrist Strap and Bonding Wire** – The wrist strap and bonding wire can be either directly connected between your wrist and bare metal on the hardware if the ESD mat is not required, or connected to the anti-static mat to protect hardware that is temporarily placed on the mat. The physical connection of the wrist strap and bonding wire between your skin, the ESD mat, and the hardware is known as bonding. Use only Field Service kits with a wrist strap, mat, and bonding wire. Never use wireless wrist straps. Always be aware that the internal wires of a wrist strap are prone to damage from normal wear and tear, and must be checked regularly with a wrist strap tester in order to avoid accidental ESD hardware damage. It is recommended to test the wrist strap and bonding wire at least once per week.
- **ESD Wrist Strap Tester** – The wires inside of an ESD strap are prone to damage over time. When using an unmonitored kit, it is a best practice to regularly test the strap prior to each service call, and at a minimum, test once per week. A wrist strap tester is the best method for doing this test. If you do not have your own wrist strap tester, check with your regional office to find out if they have one. To perform the test, plug the wrist-strap's bonding-wire into the tester while it is strapped to your wrist and push the button to test. A green LED is lit if the test is successful; a red LED is lit and an alarm sounds if the test fails.
- **Insulator Elements** – It is critical to keep ESD sensitive devices, such as plastic heat sink casings, away from internal parts that are insulators and often highly charged.
- **Working Environment** – Before deploying the ESD Field Service kit, assess the situation at the customer location. For example, deploying the kit for a server environment is different than for a desktop or portable environment. Servers are typically installed in a rack within a data center; desktops or portables are typically placed on office desks or cubicles. Always look for a large open flat work area that is free of clutter and large enough to deploy the ESD kit with additional space to accommodate the type of system that is being repaired. The workspace should also be free of insulators that can cause an ESD event. On the work area, insulators such as Styrofoam and other plastics should always be moved at least 12 inches or 30 centimeters away from sensitive parts before physically handling any hardware components

- **ESD Packaging** – All ESD-sensitive devices must be shipped and received in static-safe packaging. Metal, static-shielded bags are preferred. However, you should always return the damaged part using the same ESD bag and packaging that the new part arrived in. The ESD bag should be folded over and taped shut and all the same foam packing material should be used in the original box that the new part arrived in. ESD-sensitive devices should be removed from packaging only at an ESD-protected work surface, and parts should never be placed on top of the ESD bag because only the inside of the bag is shielded. Always place parts in your hand, on the ESD mat, in the system, or inside an anti-static bag.
- **Transporting Sensitive Components** – When transporting ESD sensitive components such as replacement parts or parts to be returned to Dell, it is critical to place these parts in anti-static bags for safe transport.

ESD protection summary

It is recommended to use the traditional wired ESD grounding wrist strap and protective anti-static mat at all times when servicing Dell products. In addition, it is critical to keep sensitive parts separate from all insulator parts while performing service and that they use anti-static bags for transporting sensitive components.

Transporting sensitive components

When transporting ESD sensitive components such as replacement parts or parts to be returned to Dell, it is critical to place these parts in anti-static bags for safe transport.

After working inside your computer

About this task

 **CAUTION:** Leaving stray or loose screws inside your computer may severely damage your computer.

Steps

1. Replace all screws and ensure that no stray screws remain inside your computer.
2. Connect any external devices, peripherals, or cables you removed before working on your computer.
3. Replace any media cards, discs, or any other parts that you removed before working on your computer.
4. Connect your computer and all attached devices to their electrical outlets.
 -  **NOTE:** To exit service mode, ensure to connect the AC adapter to the power-adapter port on your computer.
5. Press the power button to turn on the computer. Your computer will automatically return to normal functioning mode.

BitLocker

 **CAUTION:** If BitLocker is not suspended before updating the BIOS, the next time you reboot the system it will not recognize the BitLocker key. You will then be prompted to enter the recovery key to progress, and the system will ask for this on each reboot. If the recovery key is not known this can result in data loss or an unnecessary operating system reinstall. For more information about this subject, see Knowledge Article: [updating the BIOS on Dell systems with BitLocker enabled](#).

The installation of the following components triggers BitLocker:

- Hard disk drive or solid state drive
- System board

Recommended tools

The procedures in this document may require the following tools:

- Phillips screwdriver #0
- Phillips screwdriver #1
- Torx #5 (T5) screwdriver

- Plastic scribe

Screw list

- i** **NOTE:** When removing screws from a component, it is recommended to note the screw type, the quantity of screws, and then place them in a screw storage box. This is to ensure that the correct number of screws and correct screw type is restored when the component is replaced.
- i** **NOTE:** Some computers have magnetic surfaces. Ensure that the screws are not left attached to such surfaces when replacing a component.
- i** **NOTE:** Screw color may vary with the configuration ordered.

Table 30. Screw list

























Component	Screw type	Quantity	Screw image
Base cover	M2x3 (T5 Torx screw)	8	
M.2 2230 Solid-state drive	M2x2	2	
M.2 2280 Solid-state drive	M2x2	1	
VPU card	M2x2	2	
Battery	M2x4	6	
Left fan	M2x4	2	
Right fan	M2x4	2	
Heatsink	Captive screws	7	
Display hinges	M2.5x5	8	
Display FPC cable	M1.4x4 (T5 Torx screw)	2	
Display FPC cover	M1.4x4 (T5 Torx screw)	2	
SD card reader daughterboard	M2x1.5	3	
USH and SD card reader daughterboard	M2x1.5	4	
Smart-card reader	M1.6x1.7	2	

Table 30. Screw list (continued)

Component	Screw type	Quantity	Screw image
GPU card FPC	M1.4x4 (T5 Torx screw)	4	
GPU card bridge	M1.6x4.5	4	
PC bridge bracket	M2x4	2	
GPU card	M2x4	2	
Dummy GPU card	M2x4	2	
System board	M2x4	9	
Speakers	M1.6x1.8	4	
Touchpad FPC	M1.4x1.2	2	
SD card reader daughterboard FPC/USH and SD card reader daughterboard FPC	M1.4x1.2	2	
WLAN antennas	Captive screws	4	
Power button with fingerprint reader	M1.6x2	3	

Major components of Dell Precision 5680

The following image shows the major components of Dell Precision 5680.

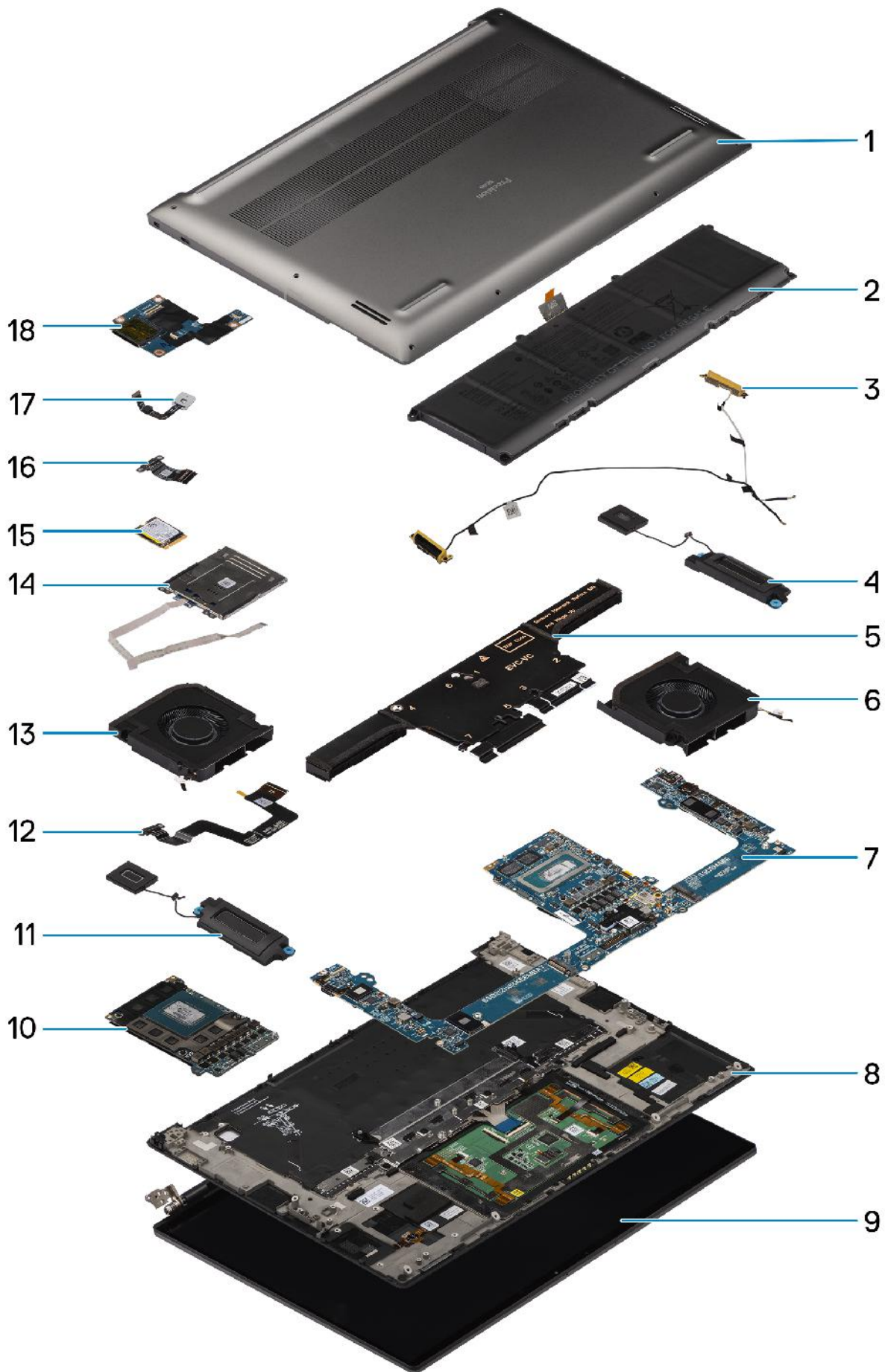

1. Base cover
2. Battery
3. WLAN antennas
4. Left speaker
5. Heatsink
6. Left fan
7. System board
8. Palm-rest and keyboard assembly
9. Display assembly
10. GPU card
11. Right speaker
12. Touchpad FPC cable
13. Right fan
14. Smart-card reader
15. Solid-state drive
16. USH and SD card reader daughterboard FPC/SD card reader daughterboard FPC
17. Power button with fingerprint reader
18. USH and SD card reader daughterboard

 **NOTE:** Dell provides a list of components and their part numbers for the original system configuration purchased. These parts are available according to warranty coverages purchased by the customer. Contact your Dell sales representative for purchase options.

Removing and installing Customer Replaceable Units (CRUs)

The replaceable components in this chapter are Customer Replaceable Units (CRUs).

CAUTION: Customers can replace only the Customer Replaceable Units (CRUs) following the safety precautions and replacement procedures.

NOTE: The images in this document may differ from your computer depending on the configuration you ordered.

Secure Digital (SD) Card

Removing the SD card

Prerequisites

Follow the procedure in [Before working inside your computer](#).

NOTE: Ensure that your computer is in Service Mode. For more information see, step 6 in [Before working inside your computer](#).

About this task

The following image indicates the location and provides a visual representation of the SD card removal procedure.



Steps

1. Push the SD card to eject it from the slot.
2. Remove the SD card from the computer.

Installing the SD card

Prerequisites

If you are replacing a component, remove the existing component before performing the installation procedure.

About this task

The following image provides a visual representation of the SD card installation procedure.



Steps

Insert the SD card into its slot until it click into place.

Next steps

1. Follow the procedure in [After working inside your computer.](#)

Removing and installing Field Replaceable Units (FRUs)

The replaceable components in this chapter are Field Replaceable Units (FRUs).

CAUTION: The information in this section is intended for authorized service technicians only.

CAUTION: To avoid any potential damage to the component or loss of data, ensure that an authorized service technician replaces the Field Replaceable Units (FRUs).

CAUTION: Dell Technologies recommends that this set of repairs, if needed, to be conducted by trained technical repair specialists.

CAUTION: As a reminder, your warranty does not cover damages that may occur during the courses of FRU repairs that are not authorized by Dell Technologies.

NOTE: The images in this document may differ from your computer depending on the configuration you ordered.

Base cover

Removing the base cover

Prerequisites

1. Follow the procedure in [Before working inside your computer](#).

NOTE: Ensure that your computer is in Service Mode. For more information see, step 6 in [Before working inside your computer](#).

2. Remove the [SD card](#).

About this task

CAUTION: The information in this removal section is intended for authorized service technicians only.

The following images indicate the location and provide a visual representation of the base cover removal procedure.



8x
M2x3

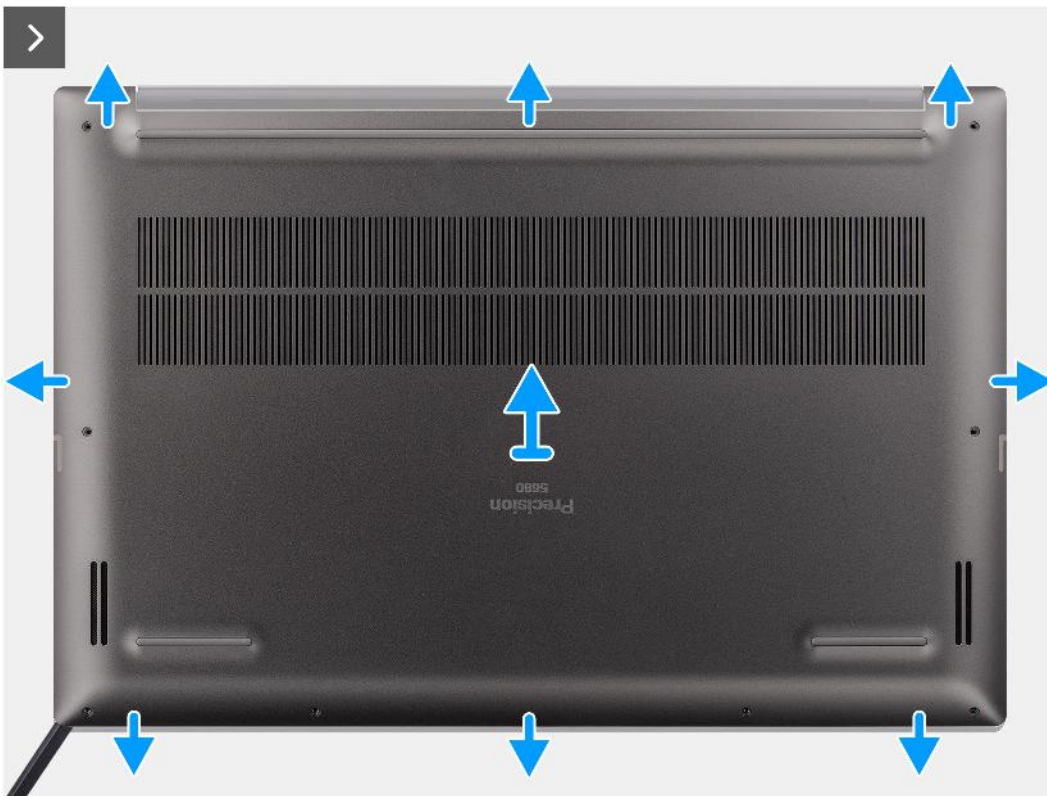

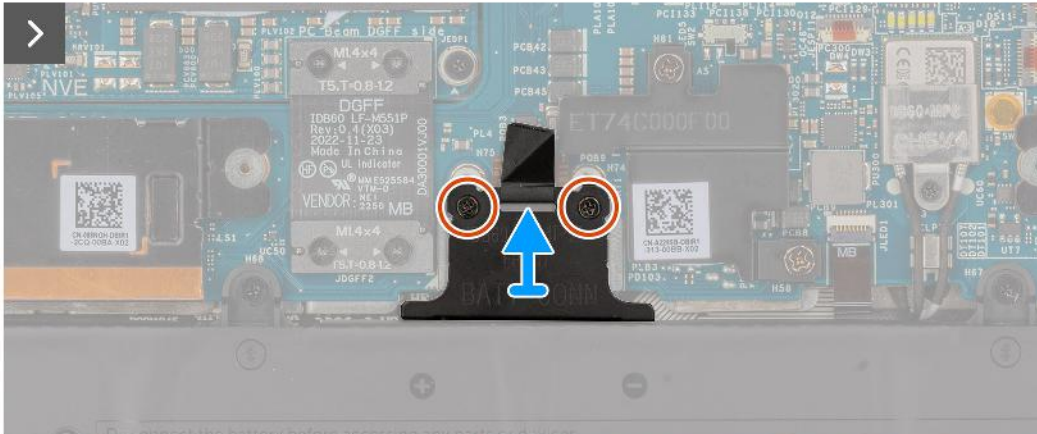

Steps

1. Remove the eight (M2x3) T5 Torx screws that secure the base cover to the computer.
2. Using a plastic scribe, pry open the base cover starting from the SD-card slot on the base cover.
 - ⚠ **CAUTION:** Do not fully insert the plastic scribe into the SD-card slot before prying. Only pry the edge of base cover nearest to the SD-card slot opening.
 - ⚠ **CAUTION:** Do not pry up from the top side (near the vents) of the base cover as this may cause damage to the rear side of the cover.
3. Work your way around the bottom, left and right sides of the base cover.
4. Lift the bottom of the base cover and push it towards the rear of the system to remove it from the computer.
 - ⚠ **CAUTION:** Do not grasp from the rear vents and lift the base cover directly upwards to remove it, as this may cause damage to the rear side of the cover.
5. Loosen the two captive screws that secure the battery connector bracket in place.
6. Disconnect the battery FPC cable from the connector on the system board.
 - 📌 **NOTE:** Pull the pull tab vertically to disconnect the battery FPC cable.

Installing the base cover

Prerequisites

If you are replacing a component, remove the necessary component before the installation procedure.

About this task

CAUTION: The information in this installation section is intended for authorized service technicians only.

The following images indicate the location and provide a visual representation of the base cover installation procedure.



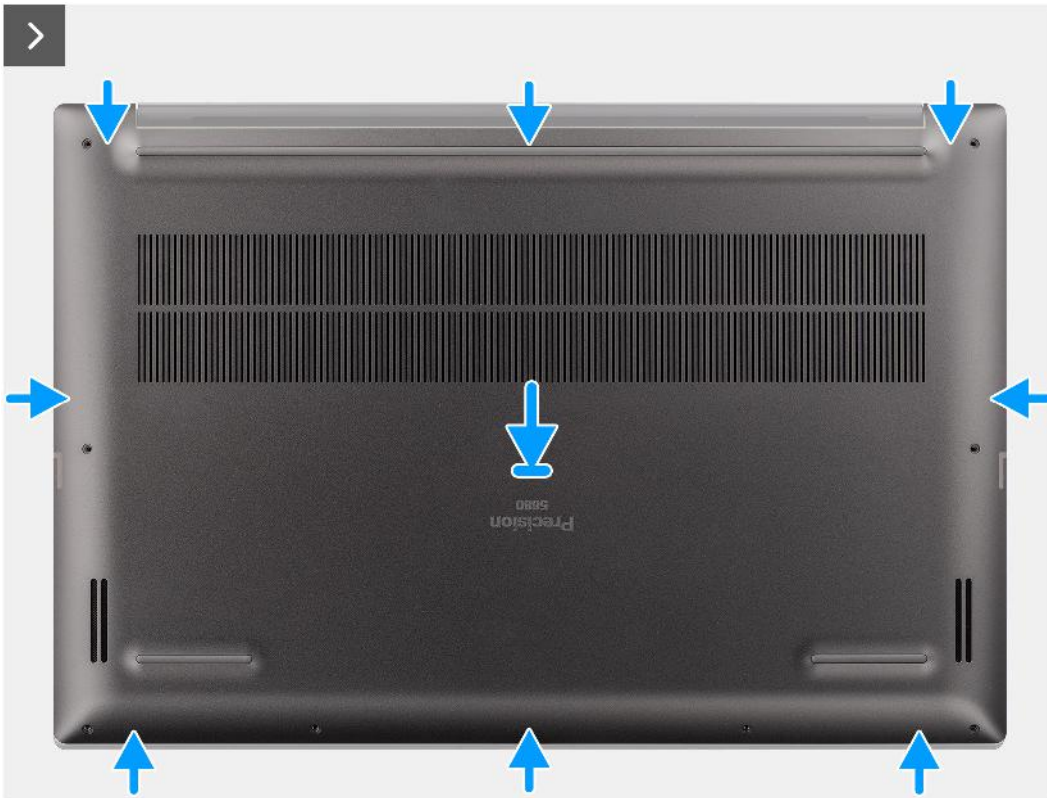

8x
M2x3



Steps

1. Connect the battery FPC cable to the connector on the system board.
2. Tighten the two captive screws to secure the battery connector bracket in place.
3. Align and place the base cover on the palm-rest assembly, and snap the base cover into place.
4. Replace the eight (M2x3) T5 Torx screws to secure the base cover to the computer.

Next steps

1. Install the [SD card](#).
2. Follow the procedure in [After working inside your computer](#).

Solid-state drive

Removing the M.2 2230 solid-state drive

Prerequisites

1. Follow the procedure in [Before working inside your computer](#).

 **NOTE:** Ensure that your computer is in Service Mode. For more information see, step 6 in [Before working inside your computer](#).

2. Remove the [SD card](#).
3. Remove the [base cover](#).

About this task

 **CAUTION:** The information in this removal section is intended for authorized service technicians only.

The following images indicate the location of the solid-state drive and provide a visual representation of the removal procedure.

 **NOTE:** The following procedure is applicable for models shipped with an M.2 2230 solid-state drive in the SSD1 and/or SSD2 slot.

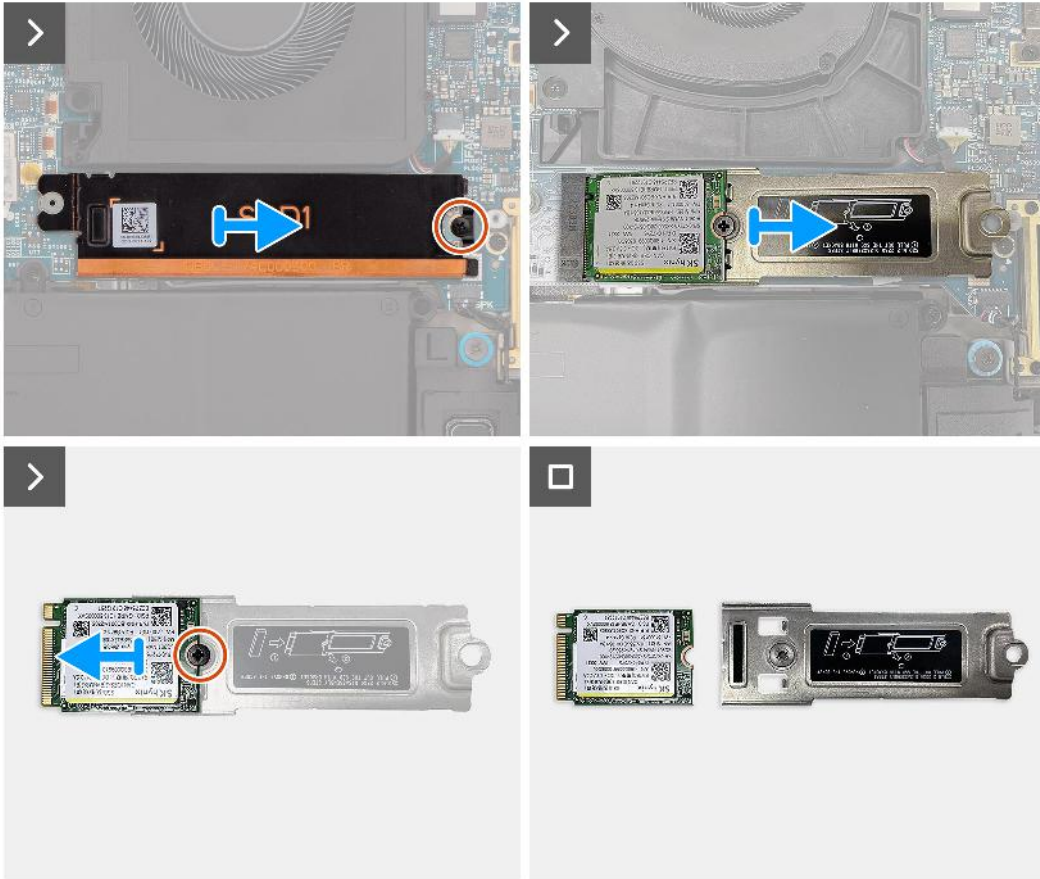
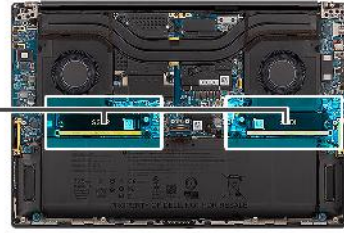

Steps

1. Remove the single (M2x2) screw that secures the solid-state drive thermal plate in place.
2. Remove the solid-state drive thermal plate from the system board.
3. Remove the M.2 2230 solid-state drive with the solid-state drive bracket from the system board.
4. Remove the single (M2x2) screw that secures the M.2 2230 solid-state drive to the solid-state drive bracket.
5. Remove the M.2 2230 solid-state drive from the solid-state drive bracket.

Installing the M.2 2230 solid-state drive

Prerequisites

If you are replacing a component, remove the existing component before performing the installation procedure.

About this task

CAUTION: The information in this installation section is intended for authorized service technicians only.

The following image indicates the location of the solid-state drive and provides a visual representation of the installation procedure.

NOTE: The following procedure is applicable for models shipped with an M.2 2230 solid-state drive in the SSD1 and/or SSD2 slot.

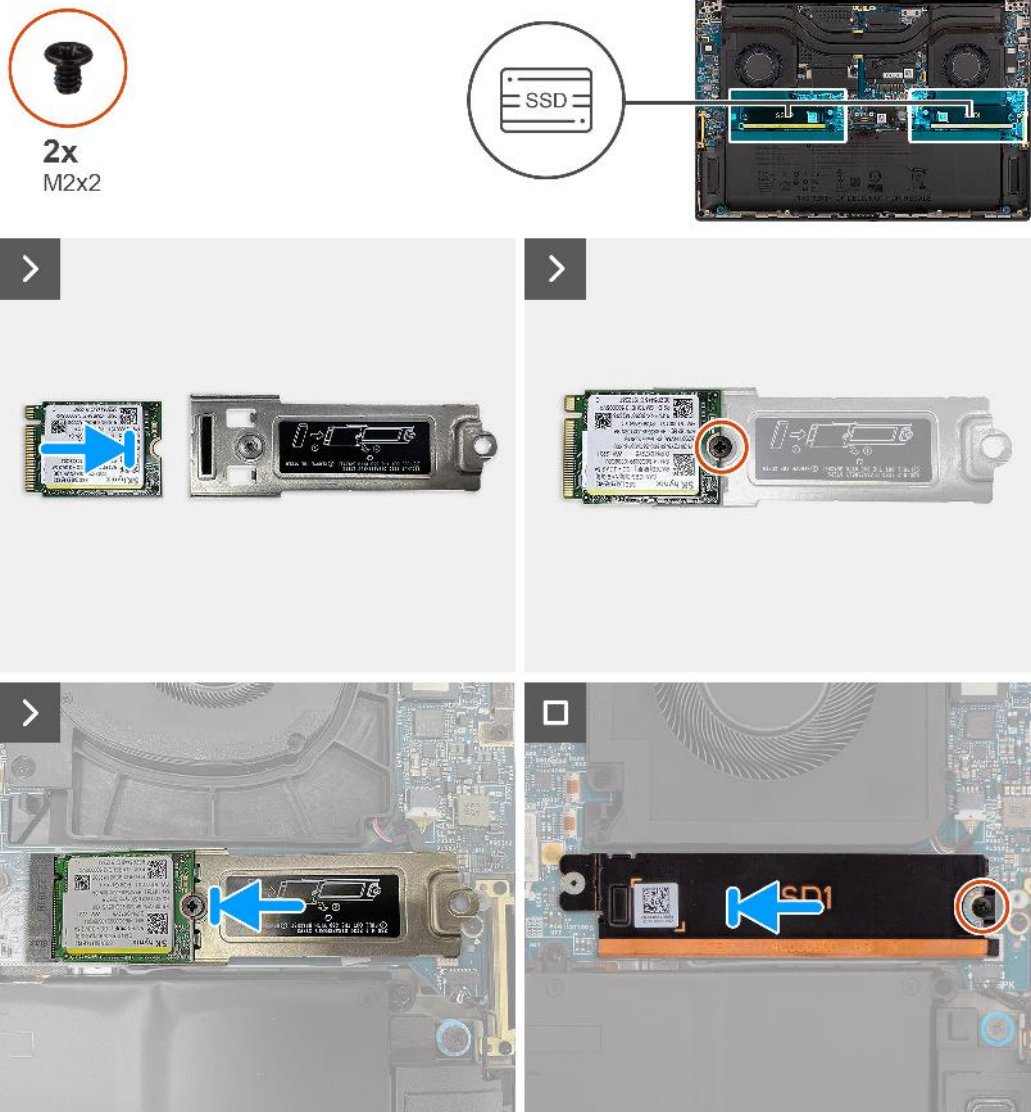

Steps

1. Align the screw hole on the M.2 2230 solid-state drive with the screw hole on the solid-state drive bracket.
2. Replace the single (M2x2) screw to secure the M.2 2230 solid-state drive to the solid-state drive bracket.
3. Align the notch on the solid-state drive with the tab on the M.2 card connector.
4. Slide the M.2 2230 solid-state drive with the solid-state drive bracket into the M.2 card connector on the system board.
5. Align and place the solid-state drive thermal plate in place.
6. Replace the single (M2x2) screw to secure the solid-state drive thermal plate to the system board.

Next steps

1. Install the [base cover](#).
2. Install the [SD card](#).
3. Follow the procedure in [After working inside your computer](#).

Removing the M.2 2280 solid-state drive

Prerequisites

1. Follow the procedure in [Before working inside your computer](#).

NOTE: Ensure that your computer is in Service Mode. For more information see, step 6 in [Before working inside your computer](#).

2. Remove the [SD card](#).
3. Remove the [base cover](#).

About this task

CAUTION: The information in this removal section is intended for authorized service technicians only.

The following images indicate the location of the solid-state drive and provide a visual representation of the removal procedure.

NOTE: The following procedure is applicable for models shipped with an M.2 2280 solid-state drive in the SSD1 and/or SSD2 slot.

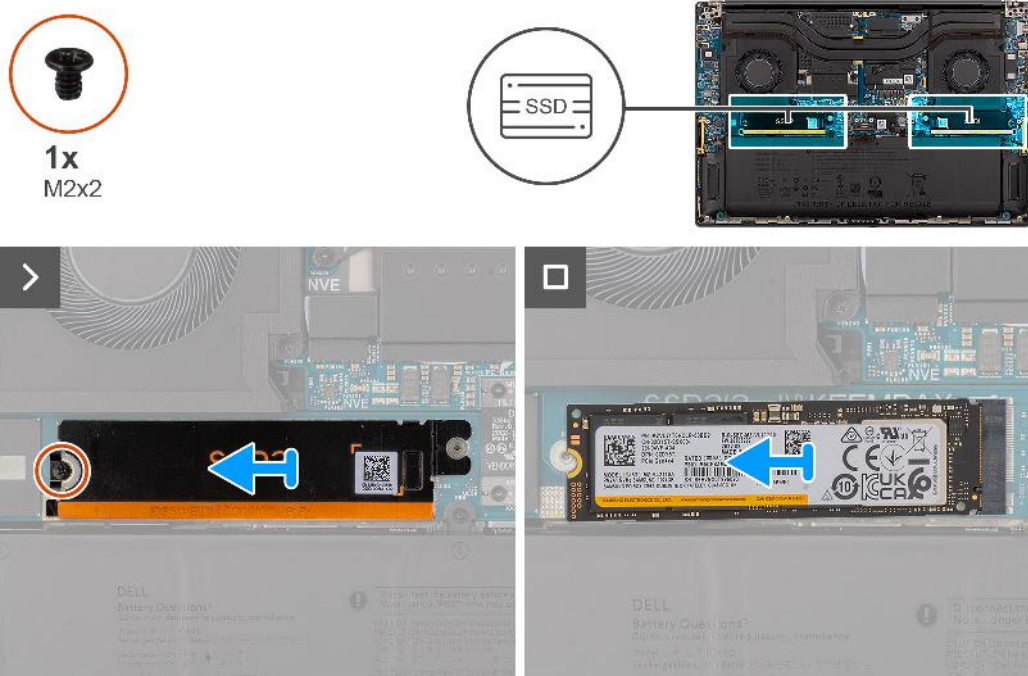

Steps

1. Remove the single (M2x2) screw that secures the solid-state drive thermal plate in place.
2. Remove the solid-state drive thermal plate from the system board.
3. Remove the M.2 2230 solid-state drive from the system board.

Installing the M.2 2280 solid-state drive

Prerequisites

If you are replacing a component, remove the existing component before performing the installation procedure.

About this task

CAUTION: The information in this installation section is intended for authorized service technicians only.

The following image indicates the location of the solid-state drive and provides a visual representation of the installation procedure.

NOTE: The following procedure is applicable for models shipped with an M.2 2280 solid-state drive in the SSD1 and/or SSD2 slot.

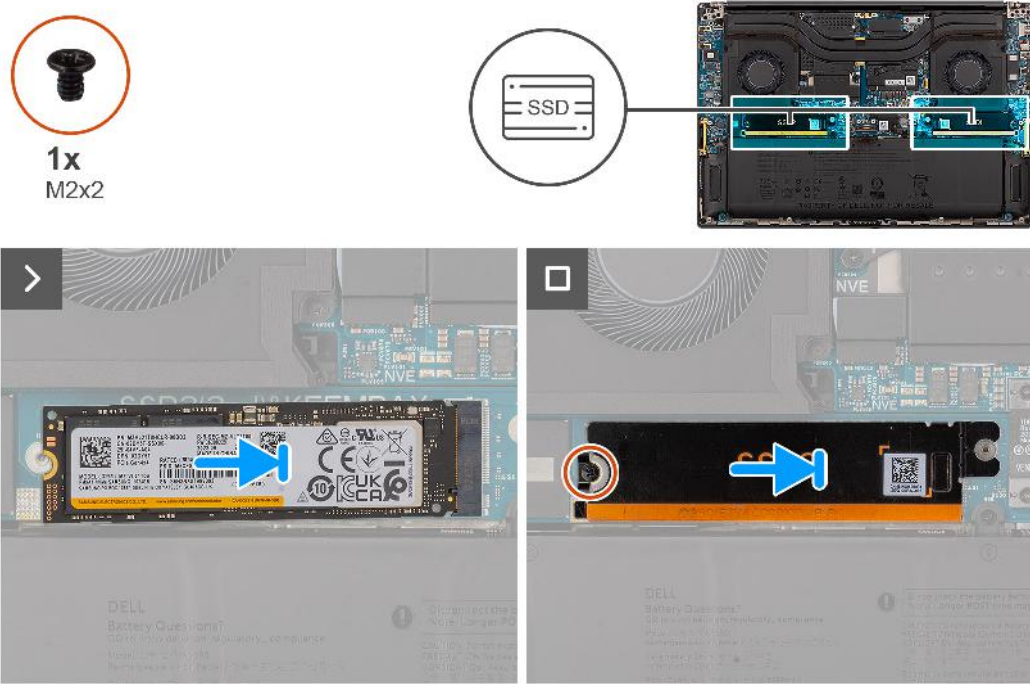

Steps

1. Align the notch on the solid-state drive with the tab on the M.2 card connector.
2. Slide the M.2 2280 solid-state drive into the M.2 card connector on the system board.
3. Align and place the solid-state drive thermal plate in place.
4. Replace the single (M2x2) screw to secure the solid-state drive thermal plate to the system board.

Next steps

1. Install the [base cover](#).
2. Install the [SD card](#).
3. Follow the procedure in [After working inside your computer](#).

VPU card

Removing the VPU card

Prerequisites

1. Follow the procedure in [Before working inside your computer](#).

NOTE: Ensure that your computer is in Service Mode. For more information see, step 6 in [Before working inside your computer](#).

2. Remove the [SD card](#).
3. Remove the [base cover](#).

NOTE: The following procedure is applicable for models shipped with a VPU card in the SSD2 slot only.

About this task

CAUTION: The information in this removal section is intended for authorized service technicians only.

The following image indicates the location of the VPU card and provides a visual representation of the removal procedure.



2x
M2x2

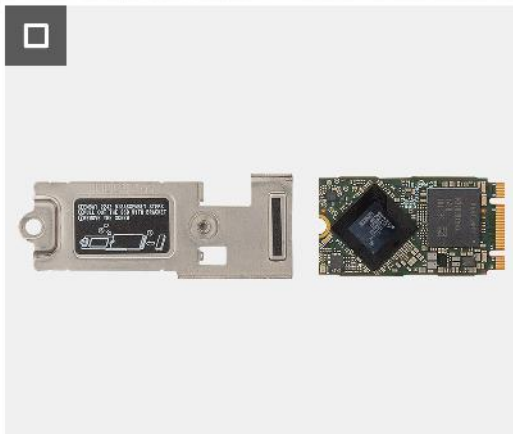
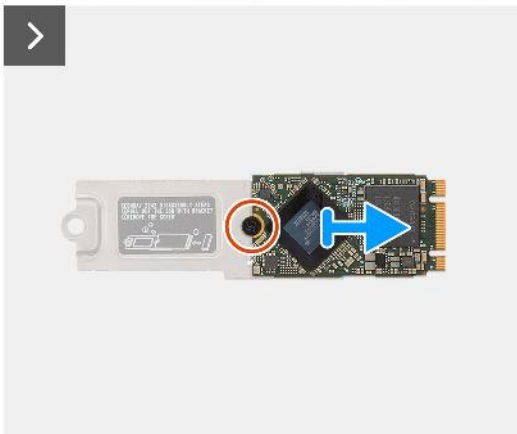
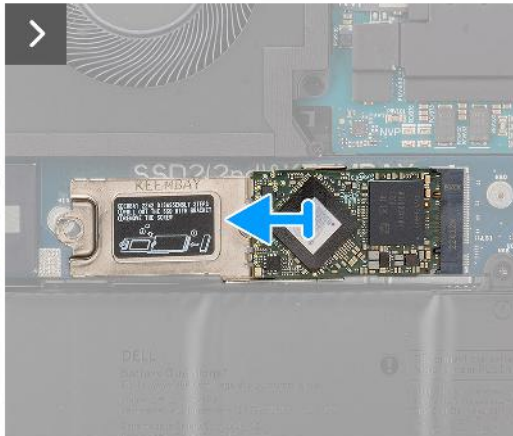
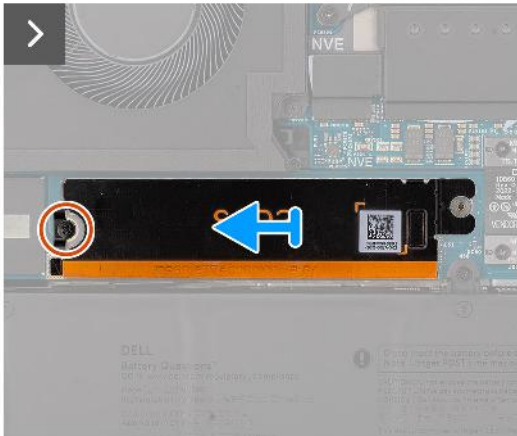

Steps

1. Remove the single (M2x2) screw that secures the VPU card thermal plate in place.
2. Remove the VPU card thermal plate from the system board.
3. Remove the VPU card with VPU card bracket from the system board.
4. Remove the single (M2x2) screw that secures the VPU card to the VPU card bracket.
5. Remove the VPU card from the VPU card bracket.

Installing the VPU card

Prerequisites

If you are replacing a component, remove the existing component before performing the installation procedure.

About this task

⚠ CAUTION: The information in this installation section is intended for authorized service technicians only.

The following image indicates the location of the VPU card and provides a visual representation of the installation procedure.

i NOTE: The following procedure is applicable for models shipped with a VPU card in the SSD2 slot only.



2x
M2x2

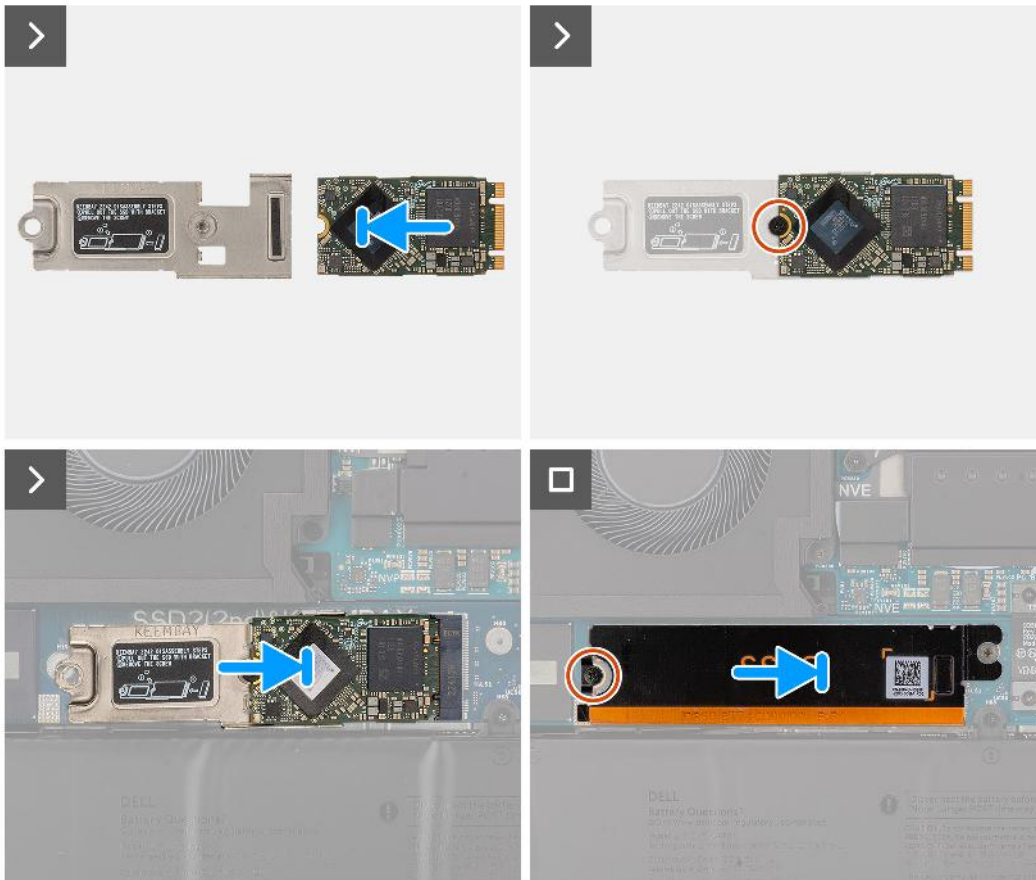

Steps

1. Align the screw hole on the VPU card with the screw hole on the VPU card bracket.
2. Replace the single (M2x2) screw to secure the VPU card to the VPU card bracket.
3. Align and place the VPU card with the VPU card bracket on the system board.
4. Align and place the VPU card thermal plate in place.
5. Replace the single (M2x2) screw to secure the VPU card thermal plate on the system board.

Next steps

1. Install the [base cover](#).
2. Install the [SD card](#).
3. Follow the procedure in [After working inside your computer](#).

Battery

Rechargeable Li-ion battery precautions

⚠ CAUTION:

- Exercise caution when handling rechargeable Li-ion batteries.
- Discharge the battery completely before removing it. Disconnect the AC power adapter from the system and operate the computer solely on battery power—the battery is fully discharged when the computer no longer turns on when the power button is pressed.
- Do not crush, drop, mutilate, or penetrate the battery with foreign objects.
- Do not expose the battery to high temperatures, or disassemble battery packs and cells.
- Do not apply pressure to the surface of the battery.
- Do not bend the battery.
- Do not use tools of any kind to pry on or against the battery.
- Ensure any screws during the servicing of this product are not lost or misplaced, to prevent accidental puncture or damage to the battery and other system components.
- If the battery gets stuck inside your computer as a result of swelling, do not try to release it as puncturing, bending, or crushing a rechargeable Li-ion battery can be dangerous. In such an instance, contact Dell technical support for assistance. See www.dell.com/contactdell.
- Always purchase genuine batteries from www.dell.com or authorized Dell partners and resellers.
- Swollen batteries should not be used and should be replaced and disposed properly. For guidelines on how to handle and replace swollen rechargeable Li-ion batteries, see [Handling swollen rechargeable Li-ion batteries](#).

Removing the battery

Prerequisites

1. Follow the procedure in [Before working inside your computer](#).
 - ⓘ **NOTE:** Ensure that your computer is in Service Mode. For more information see, step 6 in [Before working inside your computer](#).
2. Remove the [SD card](#).
3. Remove the [base cover](#).
 - ⓘ **NOTE:** If battery was disconnected from system board for service, there will be a delay during system boot-up as the system will undergo RTC battery reset.

About this task

⚠ **CAUTION:** The information in this removal section is intended for authorized service technicians only.

The following images indicate the location of the battery and provide a visual representation of the removal procedure.



6x
M2x4

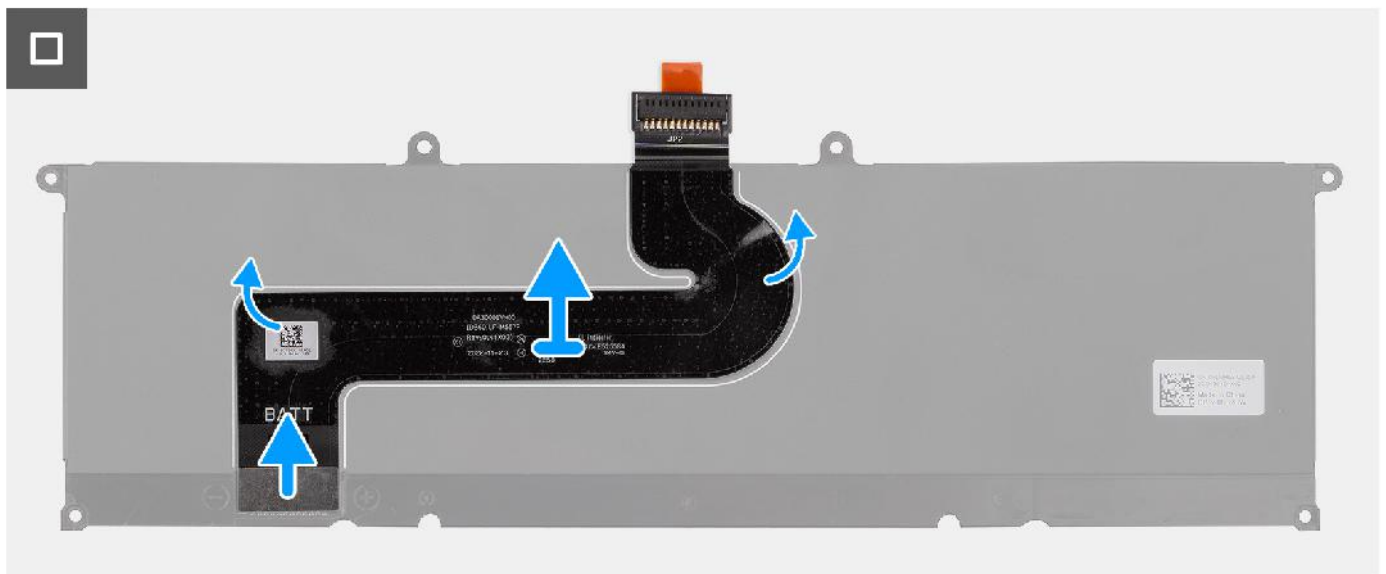
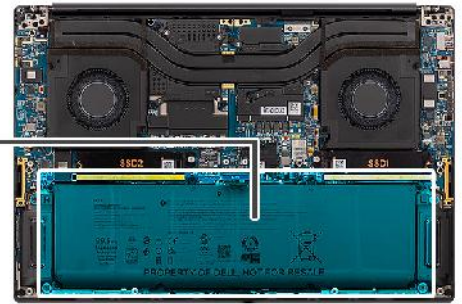
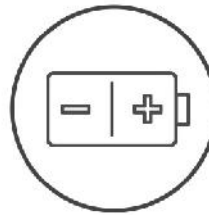

Steps

1. Remove the six (M2x4) screws that secure the battery to the palm-rest assembly.
2. Lift the battery away from the computer.
3. Peel off the battery FPC cable from the battery.
4. Disconnect and remove the battery FPC cable from the connector on the battery.

 **NOTE:** Pull the pull tab vertically to disconnect the battery FPC cable.

NOTE: When system battery is disconnected or completely discharged, the system date and time will be reset. When the system is power on under this condition, it will take slightly more time before the Dell logo is displayed, followed by the Time-of-day not set message. Select BIOS-Setup in the caution screen to configure the date and time.

Installing the battery

Prerequisites

If you are replacing a component, remove the existing component before performing the installation procedure.

About this task

CAUTION: The information in this installation section is intended for authorized service technicians only.

The following image indicates the location of the battery and provides a visual representation of the installation procedure.

NOTE: If battery was disconnected from system board for service, there will be a delay during system boot-up as the system will undergo RTC battery reset.



6x
M2x4

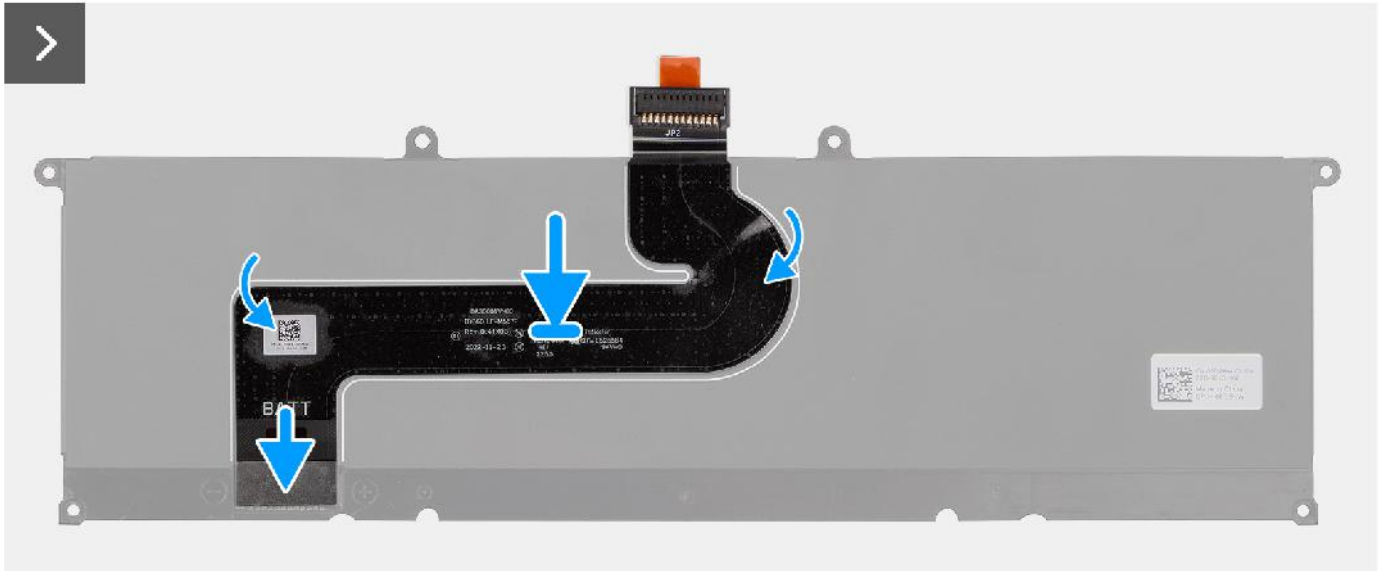
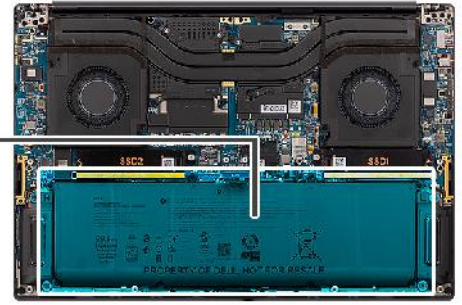
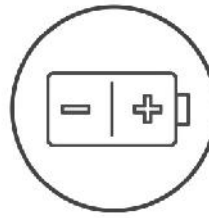

Steps

1. Connect the battery FPC cable to the connector on the battery.
2. Adhere the battery FPC cable on the battery.
3. Align and place the battery into the slot on the chassis.
4. Replace the six (M2x4) screws to secure the battery to the palm-rest assembly.

Next steps

1. Install the [base cover](#).

2. Install the [SD card](#).
3. Follow the procedure in [After working inside your computer](#).

System fan

Removing the left fan

Prerequisites

1. Follow the procedure in [Before working inside your computer](#).
 - NOTE:** Ensure that your computer is in Service Mode. For more information see, step 6 in [Before working inside your computer](#).
2. Remove the [SD card](#).
3. Remove the [base cover](#).

About this task

CAUTION: The information in this removal section is intended for authorized service technicians only.

The following images indicate the location of the left fan and provide a visual representation of the removal procedure.

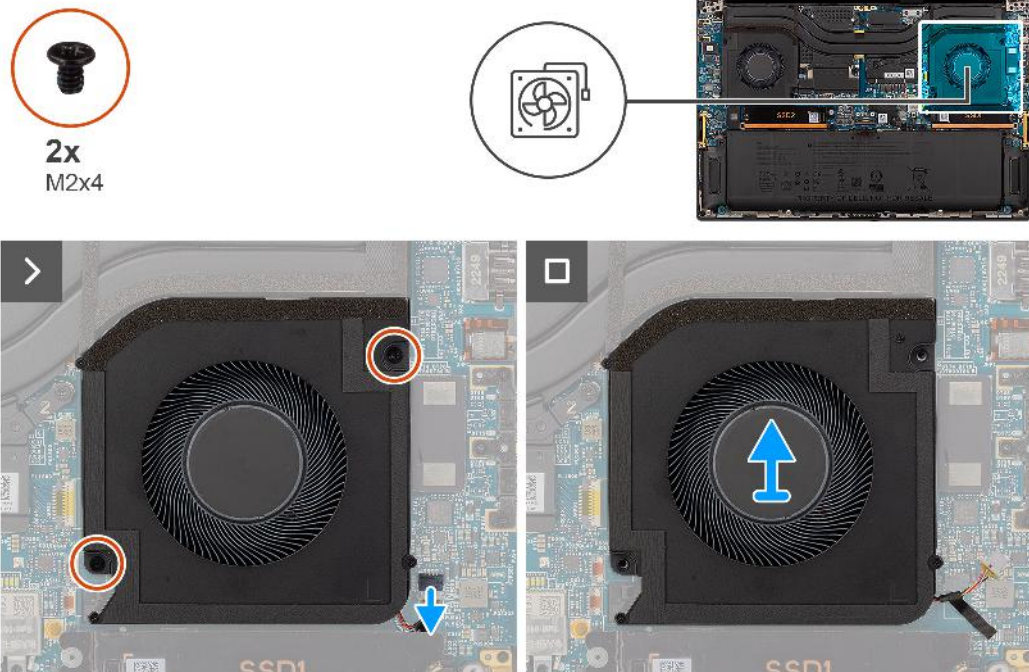

Steps

1. Disconnect the left-fan cable from the connector on the system board.
2. Remove the two (M2x4) screws that secure the left fan to the palm-rest assembly.
3. Lift the left fan from the outside and remove it from the palm-rest assembly.

Installing the left fan

Prerequisites

If you are replacing a component, remove the existing component before performing the installation procedure.

About this task

CAUTION: The information in this installation section is intended for authorized service technicians only.

The following image indicates the location of the left fan and provides a visual representation of the installation procedure.

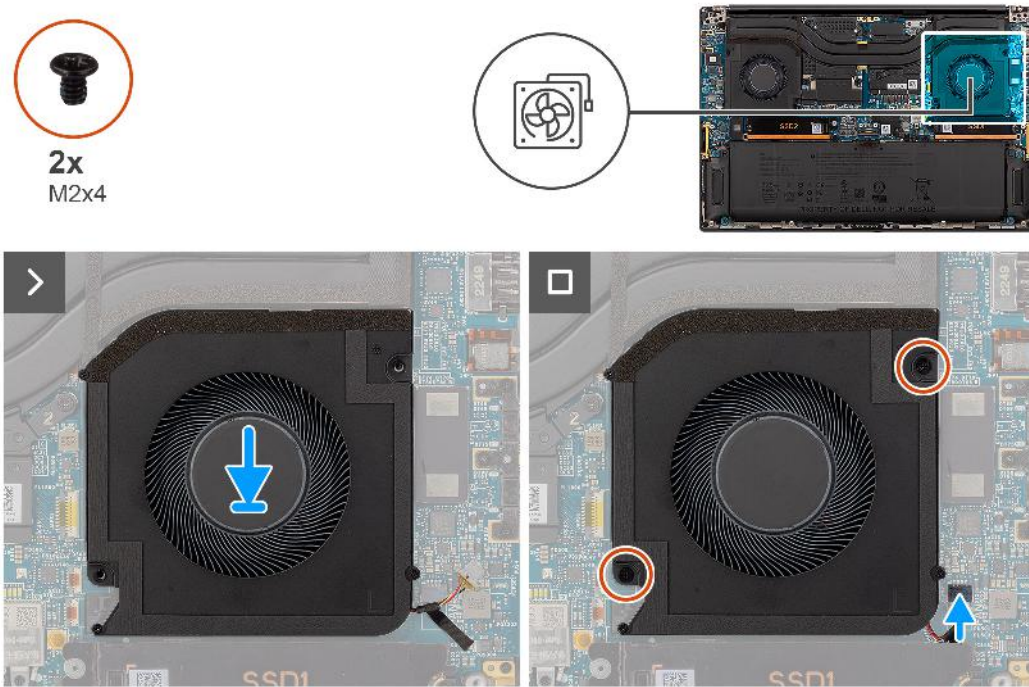

Steps

1. Align and place the left-fan onto the palm-rest assembly.
2. Replace the two (M2x4) screws to secure the left fan to the palm-rest assembly.
3. Connect the left fan cable to the connector on the system board.

Next steps

1. Install the [base cover](#).
2. Install the [SD card](#).
3. Follow the procedure in [After working inside your computer](#).

Removing the right fan

Prerequisites

1. Follow the procedure in [Before working inside your computer](#).
NOTE: Ensure that your computer is in Service Mode. For more information see, step 6 in [Before working inside your computer](#).
2. Remove the [SD card](#).
3. Remove the [base cover](#).

About this task

CAUTION: The information in this removal section is intended for authorized service technicians only.

The following images indicate the location of the right fan and provide a visual representation of the removal procedure.



2x
M2x4

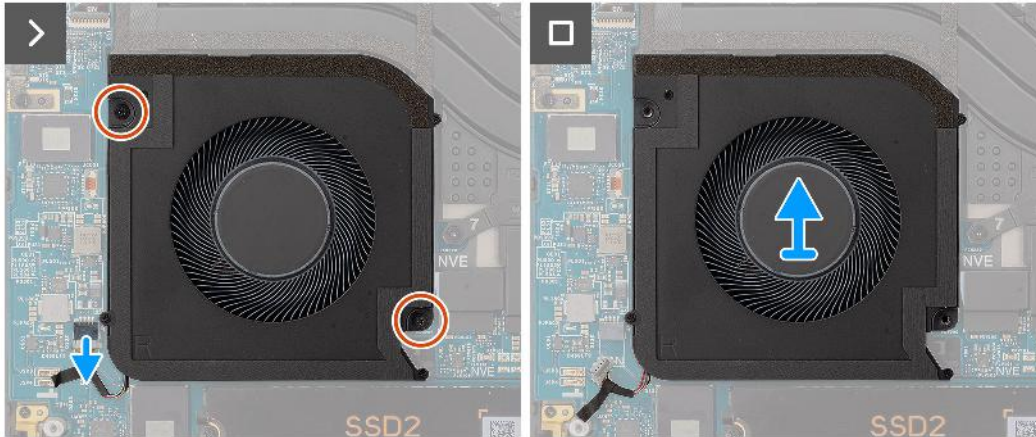
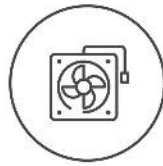

Steps

1. Disconnect the right-fan cable from the connector on the system board.
2. Remove the two (M2x4) screws that secure the right fan to the palm-rest assembly.
3. Lift the right fan from the outside and remove it from the palm-rest assembly.

Installing the right fan

Prerequisites

If you are replacing a component, remove the existing component before performing the installation procedure.

About this task

CAUTION: The information in this installation section is intended for authorized service technicians only.

The following image indicates the location of the right fan and provides a visual representation of the installation procedure.



2x
M2x4

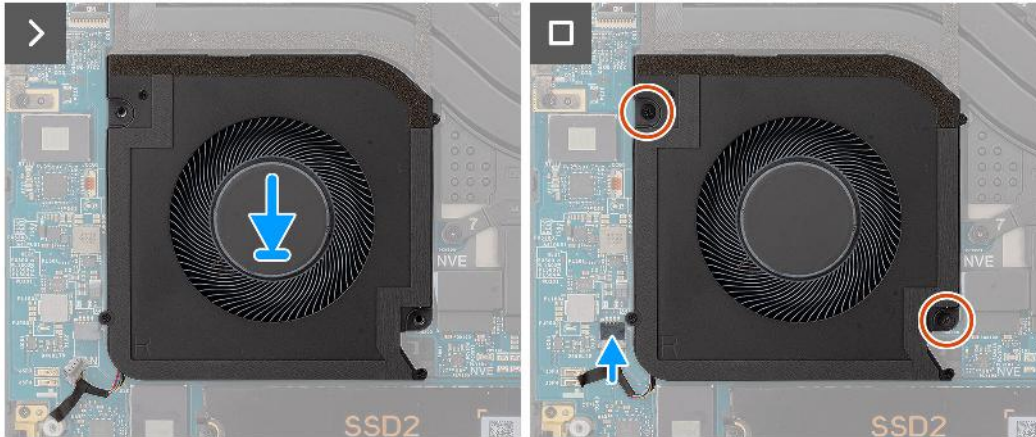
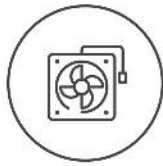

Steps

1. Align and place the right-fan onto the palm-rest assembly.
2. Replace the two (M2x4) screws to secure the right fan to the palm-rest assembly.
3. Connect the right fan cable to the connector on the system board.

Next steps

1. Install the [base cover](#).
2. Install the [SD card](#).
3. Follow the procedure in [After working inside your computer](#).

Heat sink

Removing the heat sink

Prerequisites

1. Follow the procedure in [Before working inside your computer](#).
 **NOTE:** Ensure that your computer is in Service Mode. For more information see, step 6 in [Before working inside your computer](#).
2. Remove the [SD card](#).
3. Remove the [base cover](#).

About this task

 **CAUTION:** The information in this removal section is intended for authorized service technicians only.

The following image indicates the location of the heat sink and provides a visual representation of the removal procedure.

 **NOTE:** For models shipped with a heatsink labeled “VC” (Vapor Chamber), the heatsink must be removed prior to removal of the display assembly or system board.

 **NOTE:** For models shipped with a heatsink labeled “VC” (Vapor Chamber), the heatsink covers the display cable:

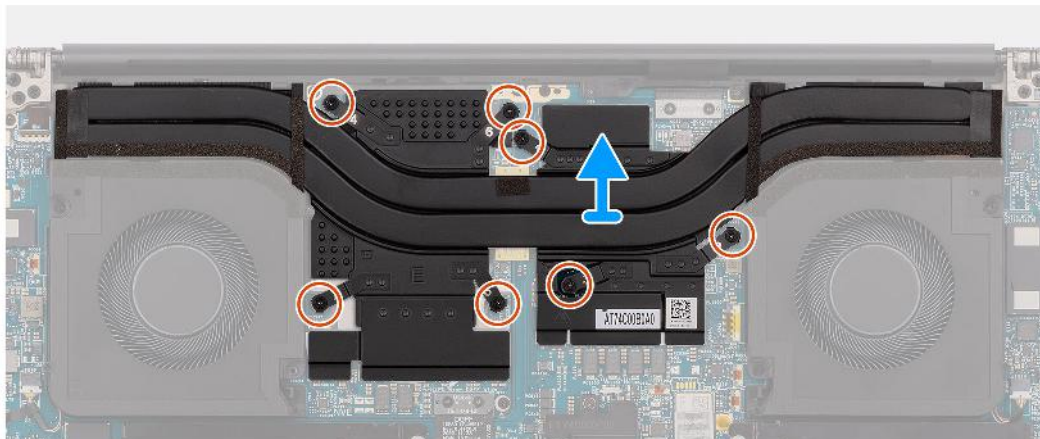

Steps

1. For systems shipped with an integrated GPU card, loosen the three captive screws in descending order (3>2>1) that secure the heat sink to the system board.
2. For systems shipped with a discrete GPU card, loosen the seven captive screws in descending order (7>6>5>4>3>2>1) that secure the heat sink to the system board.
3. Lift the heat sink off the system board.

NOTE: Thermal pads (thermal conductors) are on the heatsink. If the heatsink is replaced, the new heatsink is shipped with thermal pads. Ensure all thermal pads are in place between the heatsink and the system board.

Installing the heat sink

Prerequisites

If you are replacing a component, remove the existing component before performing the installation procedure.

About this task

CAUTION: The information in this installation section is intended for authorized service technicians only.

NOTE: For models shipped with a heatsink labeled “VC” (Vapor Chamber), the heatsink covers the display cable:

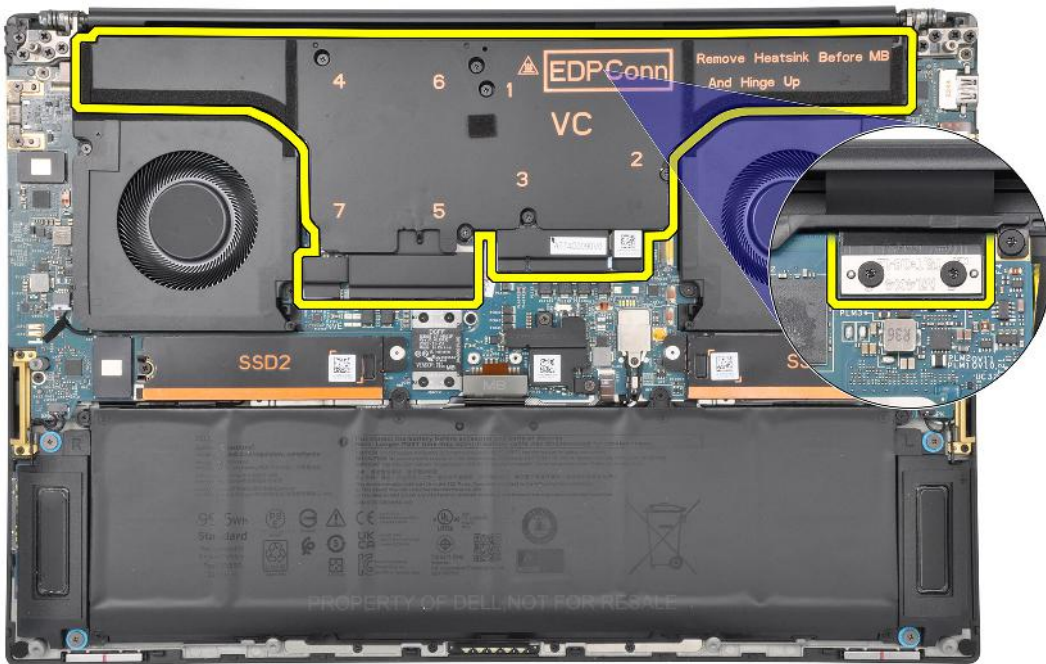

NOTE: Thermal pads (thermal conductors) are on the heatsink. If the heatsink is replaced, the new heatsink is shipped with thermal pads. Ensure all thermal pads are in place between the heatsink and the system board.

The following image indicates the location of the heat sink and provides a visual representation of the installation procedure.

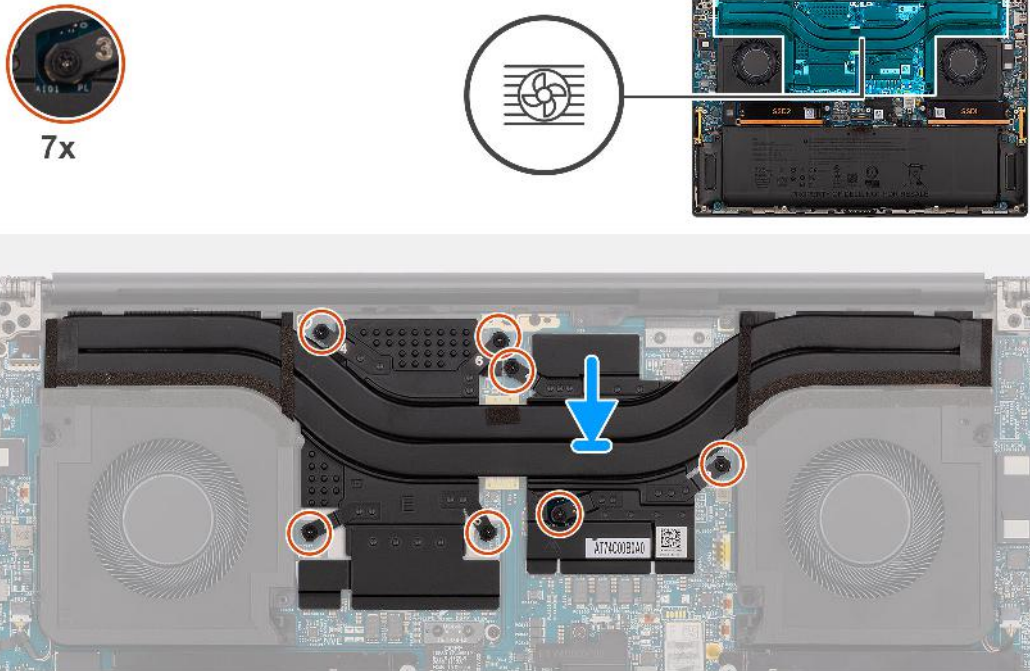

Steps

1. Align the screw holes on the heat sink with the screw holes on the system board.
2. For systems shipped with an integrated GPU card, tighten the three captive screws in ascending order (1>2>3) to secure the heat sink to the system board.
3. For systems shipped with a discrete GPU card, tighten the seven captive screws in ascending order (1>2>3>4>5>6>7) to secure the heat sink to the system board.

Next steps

1. Install the [base cover](#).
2. Install the [SD card](#).
3. Follow the procedure in [After working inside your computer](#).

Display assembly

Removing the display assembly

Prerequisites

1. Follow the procedure in [Before working inside your computer](#).
 - NOTE:** Ensure that your computer is in Service Mode. For more information see, step 6 in [Before working inside your computer](#).
2. Remove the [SD card](#).
3. Remove the [base cover](#).
4. Remove the [heatsink](#) for systems shipped with vapor chamber VC heatsink.

About this task

CAUTION: The information in this removal section is intended for authorized service technicians only.

The following images indicate the location of the display assembly and provide a visual representation of the removal procedure.

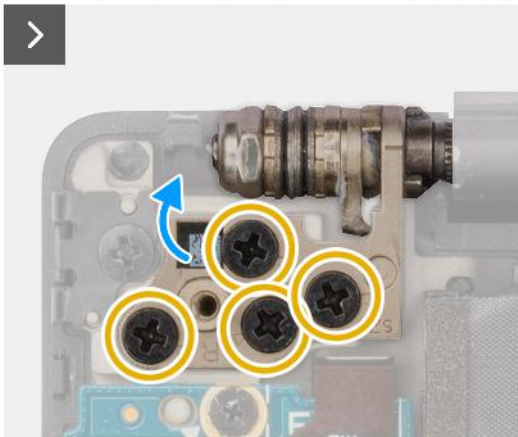
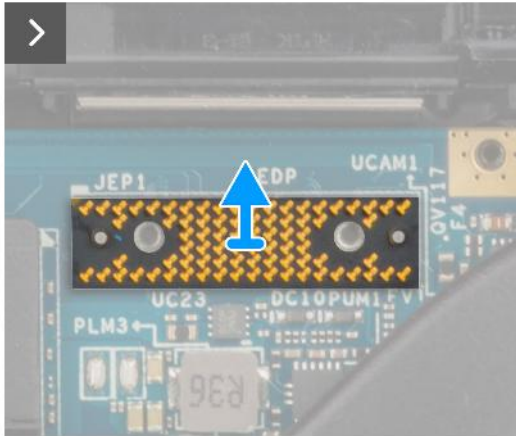
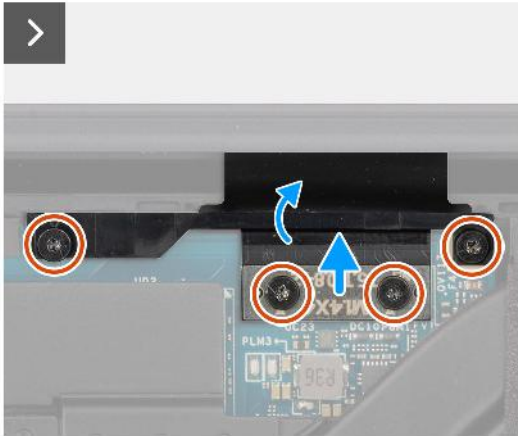
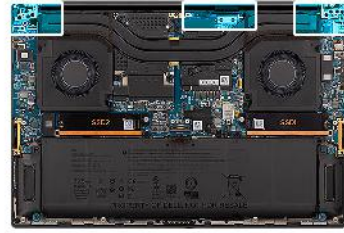

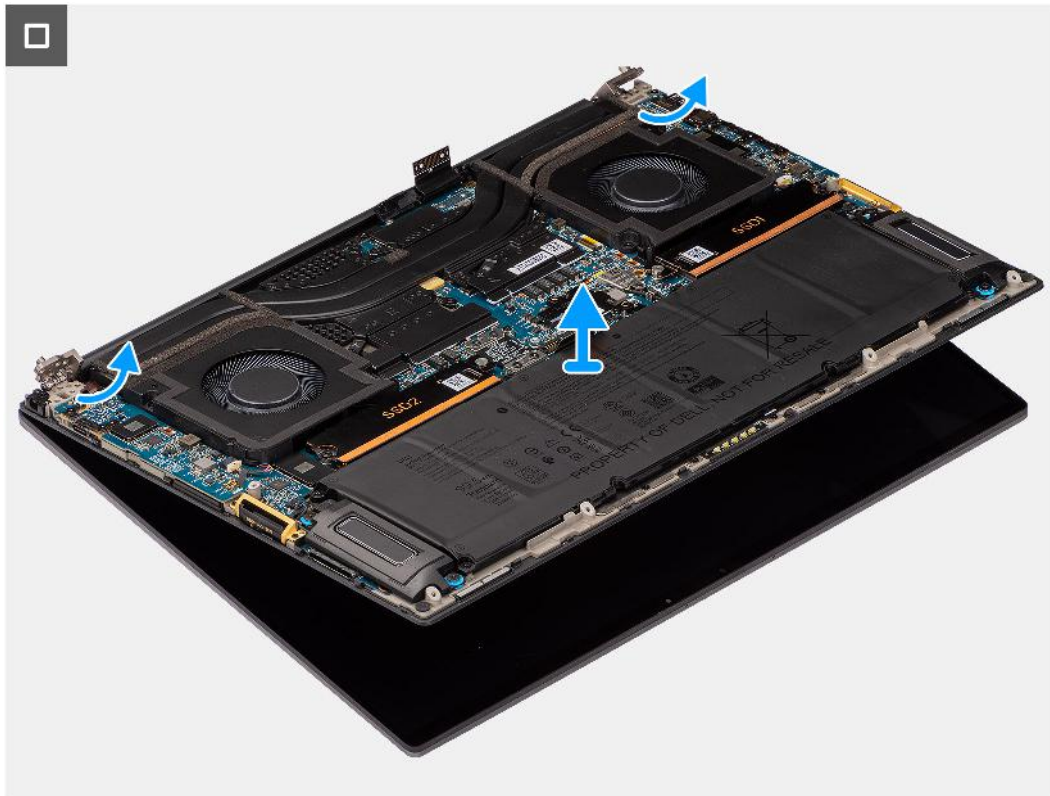

Steps

1. Remove the two (M1.4x4) T5 Torx screws that secure the display FPC cover in place.
2. Flip open the display FPC cover.
3. Remove the two (M1.4x4) T5 Torx screws that secure the display FPC cable in place.
4. Disconnect the display FPC cable from the connector on the system board.
5. Remove the imposter board from the computer.

CAUTION: Technicians must remove the interposer board immediately after disconnecting the display FPC to prevent the board from falling out of the computer during subsequent removal procedures. The pins on the interposer board are very fragile. Avoid contact with the pins on the board, instead handle the board by lifting and holding from the edges or the sides.

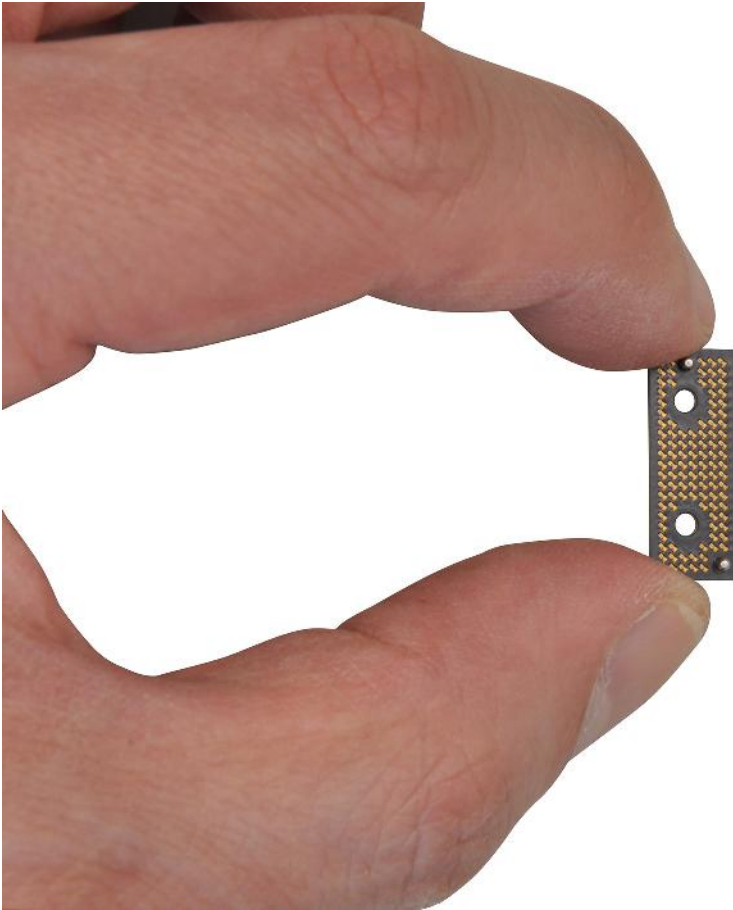

6. Remove the eight (M2.5x5) screws that secure the display assembly to the computer.
7. Slightly lift the bottom assembly and slide it to the left and away from the display assembly. Remove the display assembly from the computer.

i **NOTE:** The display assembly is a Hinge-Up Design (HUD) assembly and cannot be further disassembled once it is removed from the bottom chassis. If any components in the display assembly are malfunctioning and need to be replaced, replace the entire display assembly.

Installing the display assembly

Prerequisites

If you are replacing a component, remove the existing component before performing the installation procedure.

About this task

⚠ CAUTION: The information in this installation section is intended for authorized service technicians only.

The following image indicates the location of the display assembly and provides a visual representation of the installation procedure.

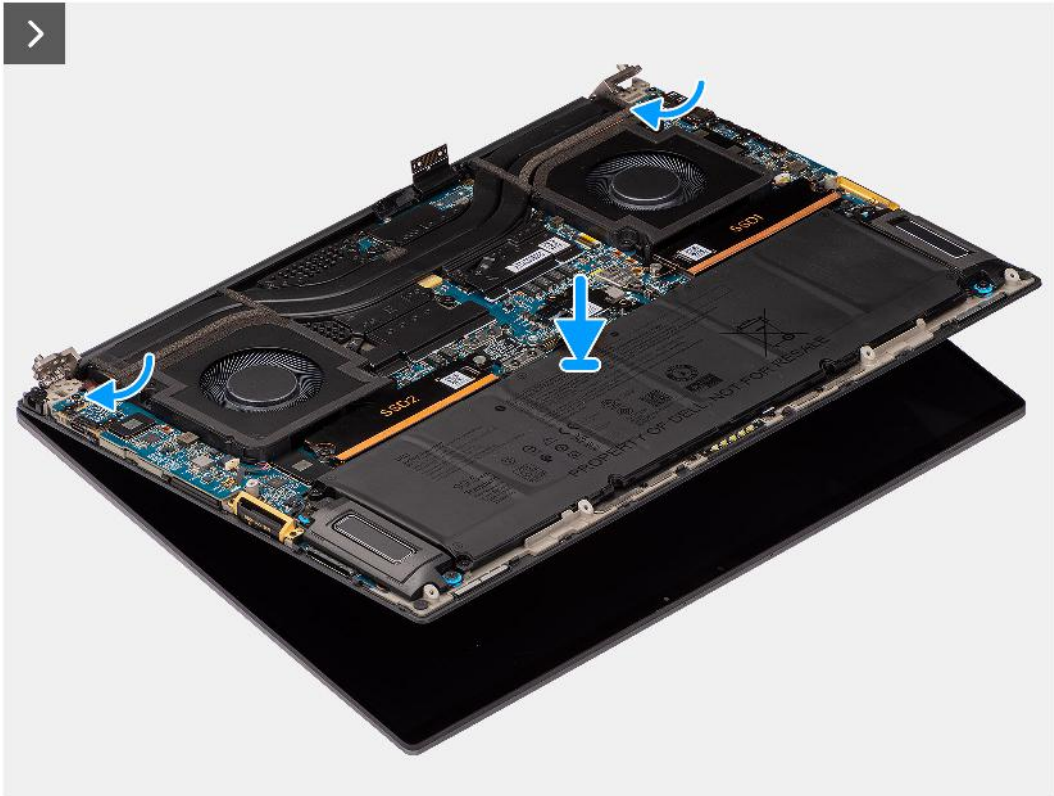

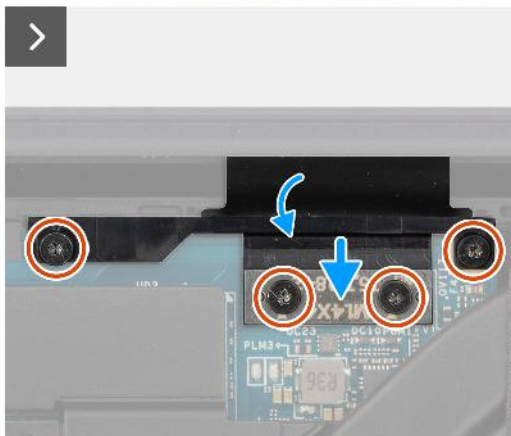
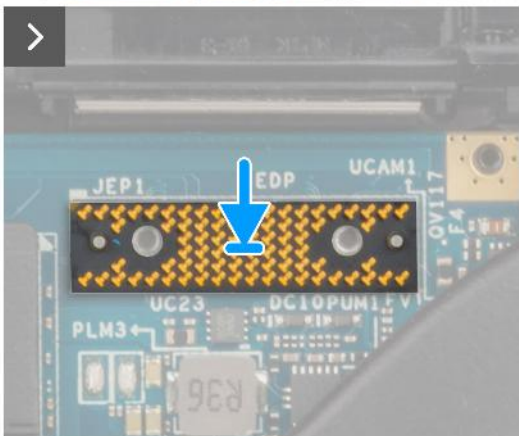
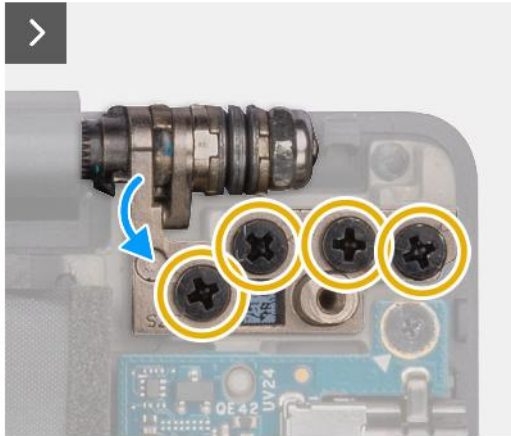
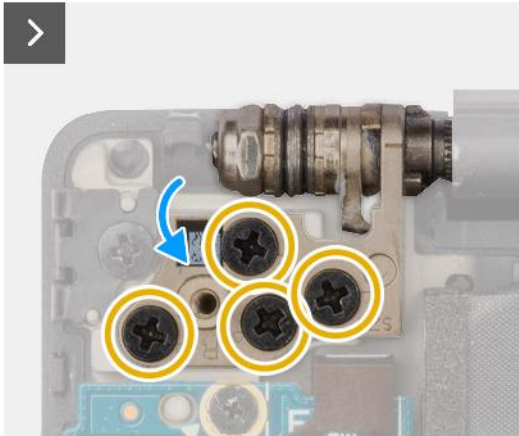
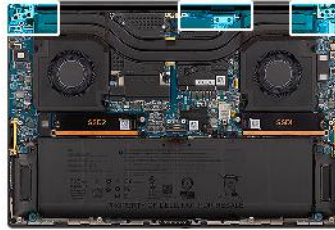

Steps

1. Align and place the bottom assembly under the hinges of the display assembly.
2. Replace the eight (M2.5x5) screws to secure the display assembly to the computer.
3. Align and place the imposter board on the computer.

CAUTION: The pins on the interposer board are very fragile. Avoid contact with the pins on the board, instead handle the board by lifting and holding from the edges or the sides.

4. Connect the display FPC cable to the connector on the system board.

- NOTE:** Tuck the display FPC into the gap between the system board and the palm-rest before connecting the display FPC to the system board.

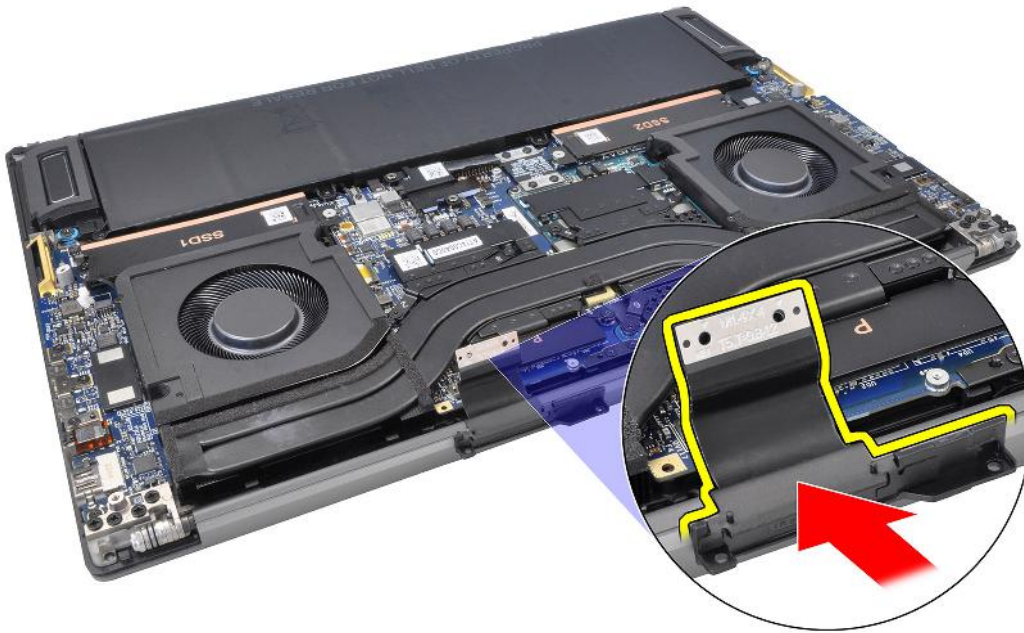

5. Replace the two (M1.4x4) T5 Torx screws to secure the display FPC cable in place.
6. Flip close the display FPC cover.
7. Replace the two (M1.4x4) T5 Torx screws to secure the display FPC cover in place.

Next steps

1. Install the [heatsink](#) for systems shipped with vapor chamber VC heatsink.
2. Install the [base cover](#).
3. Install the [SD card](#).
4. Follow the procedure in [After working inside your computer](#).

SD-card reader daughterboard

Removing the SD-card reader daughterboard

Prerequisites

1. Follow the procedure in [Before working inside your computer](#).
NOTE: Ensure that your computer is in Service Mode. For more information see, step 6 in [Before working inside your computer](#).
2. Remove the [SD card](#).
3. Remove the [base cover](#).
4. Remove the [battery](#).

About this task

CAUTION: The information in this removal section is intended for authorized service technicians only.

NOTE: The following procedure is applicable for computers shipped without a USH module only.

The following images indicate the location of the SD-card reader daughterboard and provide a visual representation of the removal procedure.

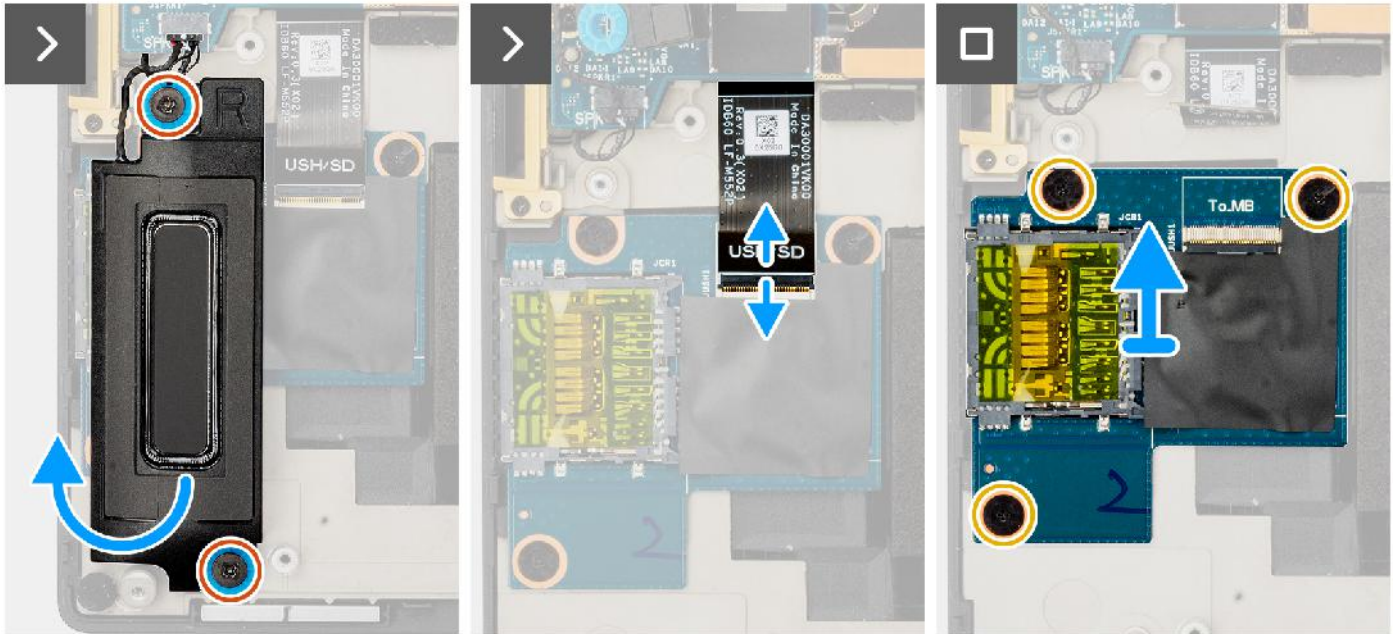

Steps

1. Remove the two (M1.6x1.8) screws that secure the right speaker in place.
2. Slightly lift the right speaker from the palm-rest assembly.

CAUTION: Do not completely remove the right speaker, as it is still attached to the tweeter underneath the system board.

3. Disconnect the SD-card reader daughterboard FFC from the connector on the SD-card reader daughterboard.
4. Remove the three (M2x1.5) screws that secure the SD-card reader daughterboard to the palm-rest assembly.
5. Lift and remove the SD-card reader daughterboard from the palm-rest assembly.

Installing the SD-card reader daughterboard

Prerequisites

If you are replacing a component, remove the existing component before performing the installation procedure.

About this task

CAUTION: The information in this installation section is intended for authorized service technicians only.

NOTE: The following procedure is applicable for systems shipped without a USH module only.

The following image indicates the location of the SD-card reader daughterboard and provides a visual representation of the installation procedure.

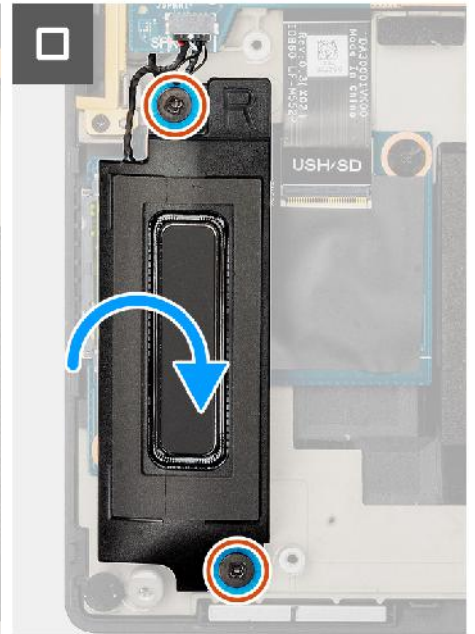
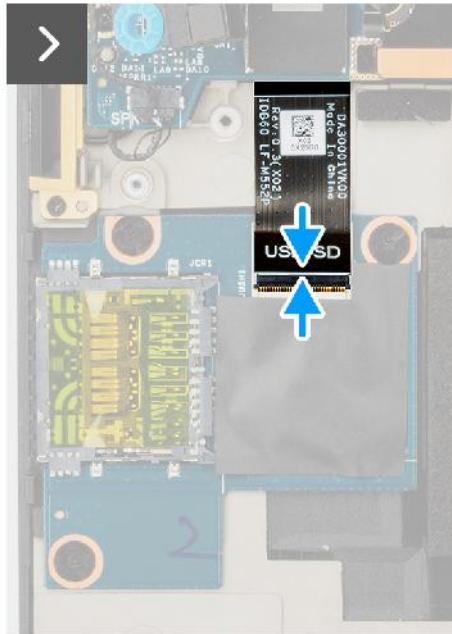
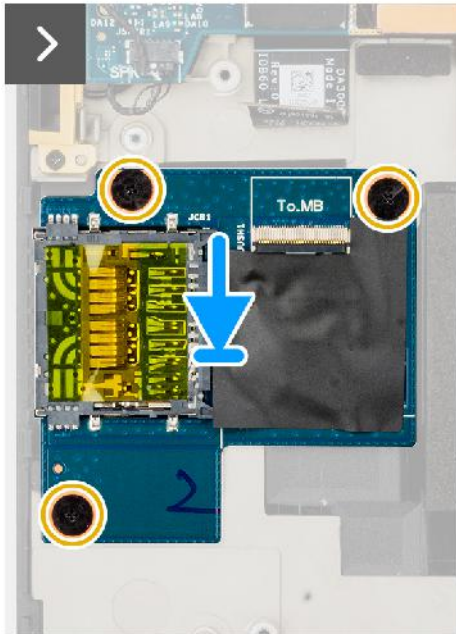

Steps

1. Align and place the SD-card reader daughterboard into the slot on the palm-rest assembly.
2. Replace the three (M2x1.5) screws to secure the SD-card reader daughterboard to the palm-rest assembly.
3. Connect the SD-card reader daughterboard FFC cable to the connector on the SD card reader daughterboard.
4. Align and place the right speaker into the slot on the palm-rest assembly.
5. Replace the two (M1.6x1.8) screws to secure the right speaker in place.

Next steps

1. Install the [battery](#).
2. Install the [base cover](#).
3. Install the [SD card](#).
4. Follow the procedure in [After working inside your computer](#).

USH and SD-card reader daughterboard

Removing the USH and SD-card reader daughterboard

Prerequisites

1. Follow the procedure in [Before working inside your computer](#).

NOTE: Ensure that your computer is in Service Mode. For more information see, step 6 in [Before working inside your computer](#).

2. Remove the [SD card](#).
3. Remove the [base cover](#).
4. Remove the [battery](#).

About this task

CAUTION: The information in this removal section is intended for authorized service technicians only.

NOTE: The following procedure is applicable for computers shipped with a USH module only.

The following images indicate the location of the USH and SD-card reader daughterboard and provide a visual representation of the removal procedure.

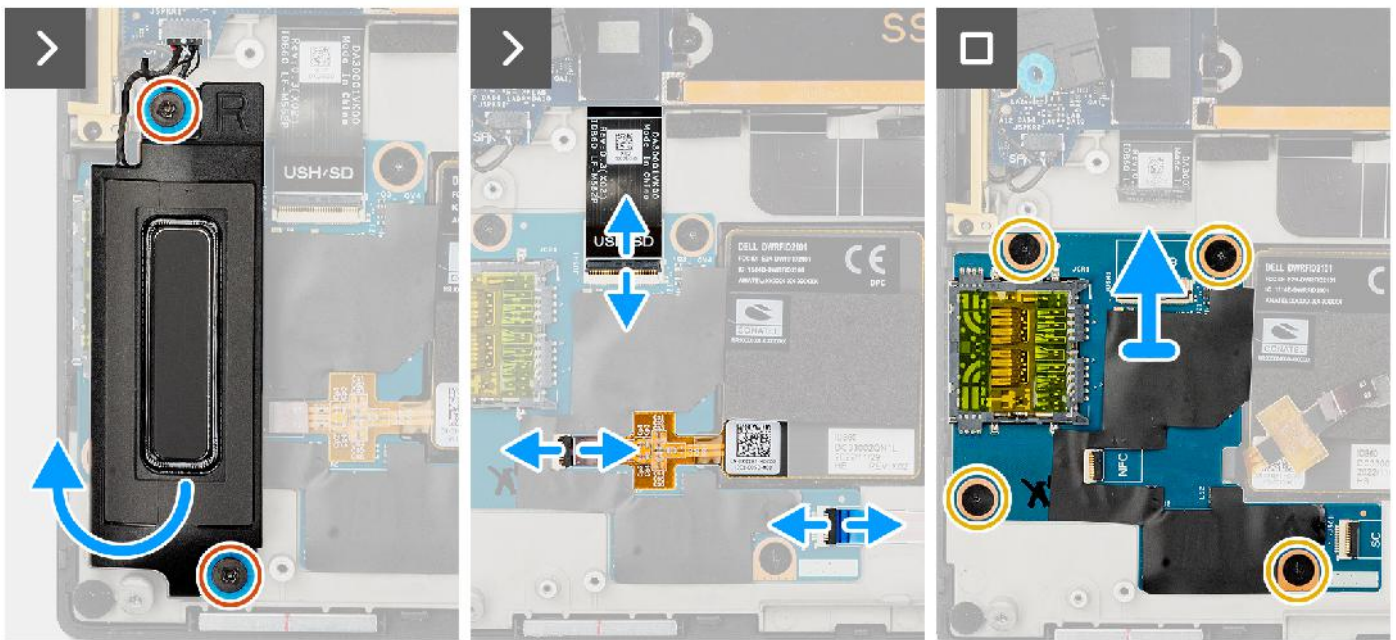
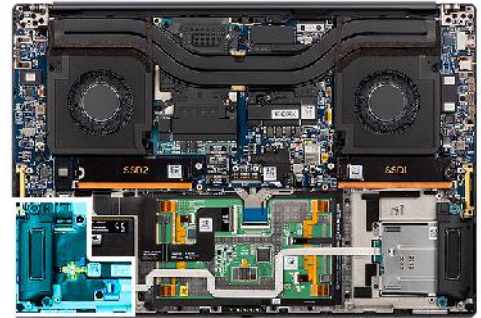

Steps

1. Remove the two (M1.6x1.8) screws that secure the right speaker in place.
2. Slightly lift the right speaker from the palm-rest assembly.
 - CAUTION:** Do not completely remove the right speaker, as it is still attached to the tweeter underneath the system board.
3. Disconnect the USH and SD-card reader daughterboard FFC cable, smart-card reader FFC cable (for systems shipped with a SmartCard) and NFC module FFC cable from the connectors on the USH and SD-card reader daughterboard.
4. Peel back the NFC module FFC from the USH and SD-card reader daughterboard.
5. Remove the four (M2x1.5) screws that secure the USH and SD-card reader daughterboard to the palm-rest assembly.
6. Lift and remove the USH and SD-card reader daughterboard from the palm-rest assembly.

Installing the USH and SD-card reader daughterboard

Prerequisites

If you are replacing a component, remove the existing component before performing the installation procedure.

About this task

CAUTION: The information in this installation section is intended for authorized service technicians only.

NOTE: The following procedure is applicable for computer shipped with a USH module only.

The following image indicates the location of the USH and SD-card reader daughterboard and provides a visual representation of the installation procedure.

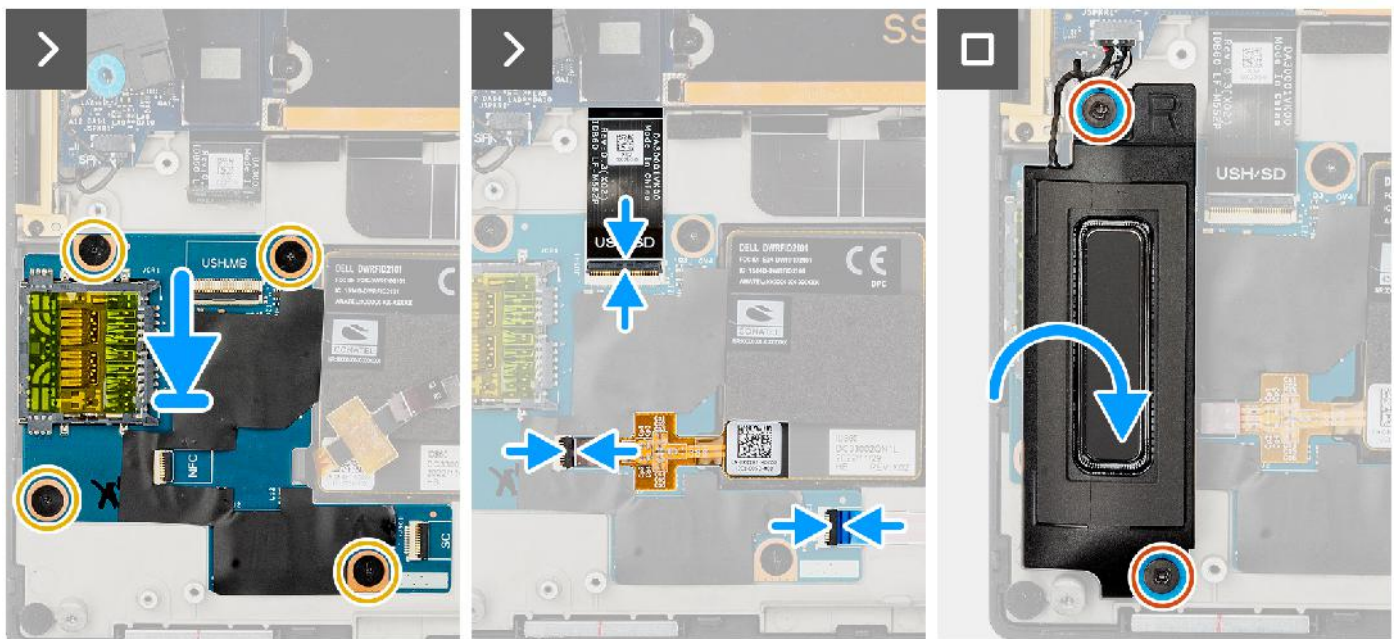

Steps

1. Align and place the USH and SD-card reader daughterboard into the slot on the palm-rest assembly.
2. Replace the four (M2x1.5) screws to secure the USH and SD-card reader daughterboard to the palm-rest assembly.
3. Adhere the NFC module FFC on the USH and SD-card reader daughterboard.
4. Connect the USH and SD-card reader daughterboard FFC cable, smart-card reader FFC cable (for systems shipped with a SmartCard) and NFC module FFC cable to the connector on the SD-card reader daughterboard.
5. Align and place the right speaker into the slot on the palm-rest assembly.
6. Replace the two (M1.6x1.8) screws to secure the right speaker in place.

Next steps

1. Install the [battery](#).
2. Install the [base cover](#).
3. Install the [SD card](#).
4. Follow the procedure in [After working inside your computer](#).

Smart-card reader

Removing the smart-card reader

Prerequisites

1. Follow the procedure in [Before working inside your computer](#).
 **NOTE:** Ensure that your computer is in Service Mode. For more information see, step 6 in [Before working inside your computer](#).
2. Remove the [SD card](#).
3. Remove the [base cover](#).
4. Remove the [Battery](#).

About this task

 **CAUTION:** The information in this removal section is intended for authorized service technicians only.

 **NOTE:** The following procedure is applicable for systems shipped with a smart-card reader only.

The following images indicate the location of the smart-card reader and provide a visual representation of the removal procedure.



2x
1.6x1.8



2x
M1.6x1.7

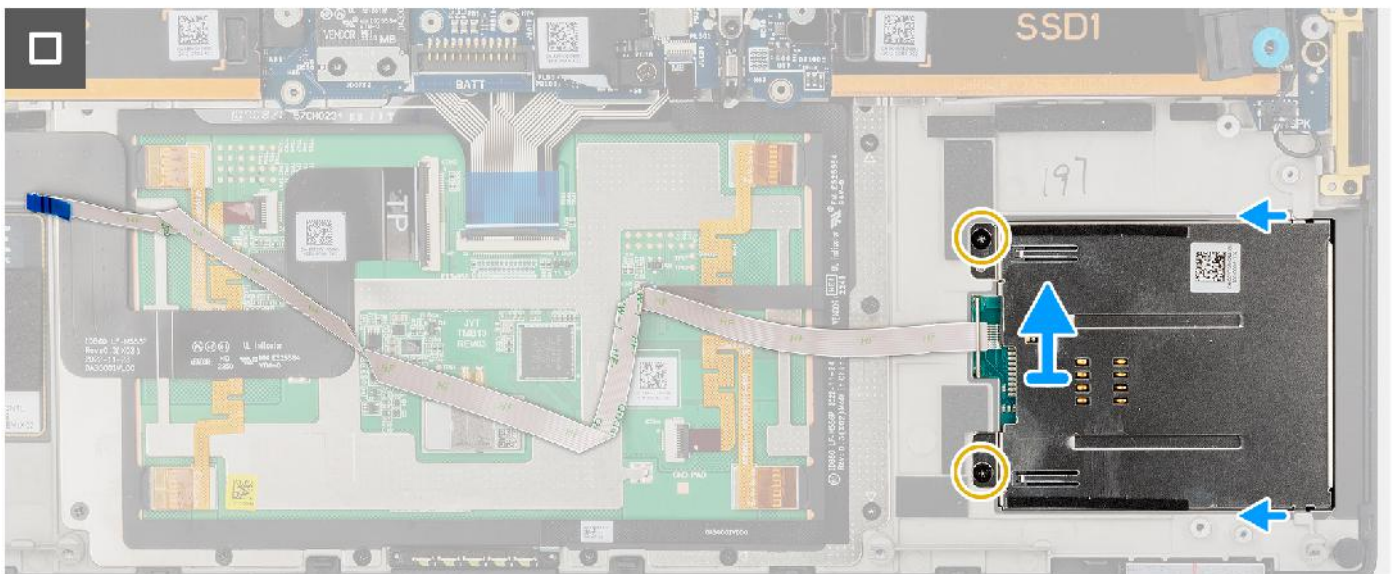
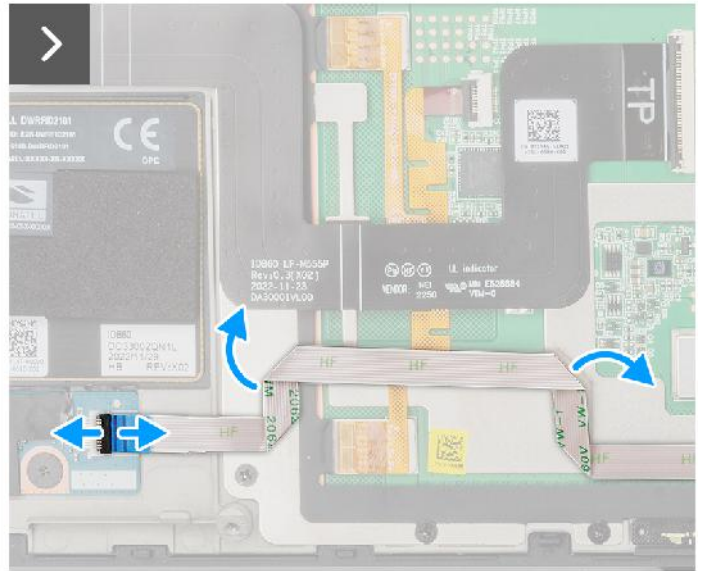
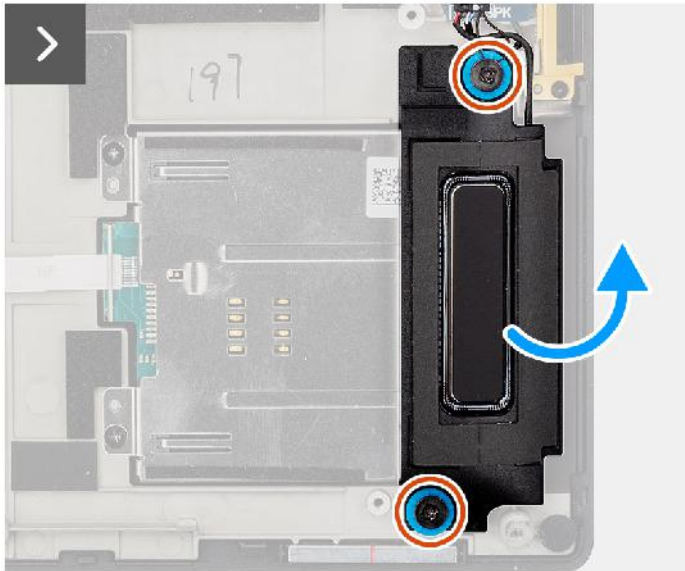
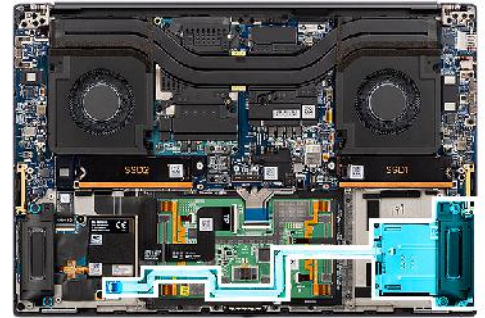

Steps

1. Remove the two (M1.6x1.8) screws that secure the left speaker in place.
2. Slightly lift the left speaker from the chassis.

CAUTION: Do not completely remove the left speaker, as it is still attached to the tweeter underneath the system board.

3. Disconnect the smart-card reader FFC cable from the connectors on the USH and SD card reader daughterboard.
4. Peel back the smart-card reader FFC from the palm-rest assembly.

5. Remove the two (M1.6x1.7) screws that secure the smart-card reader in place.
6. Lift and remove the smart-card reader with the smart-card reader FFC from the chassis.

Installing the smart-card reader

Prerequisites

If you are replacing a component, remove the existing component before performing the installation procedure.

About this task

 **CAUTION:** The information in this installation section is intended for authorized service technicians only.

 **NOTE:** The following procedure is applicable for systems shipped with a smart-card reader only.

The following image indicates the location of the smart-card reader and provides a visual representation of the installation procedure.



2x
1.6x1.8



2x
M1.6x1.7

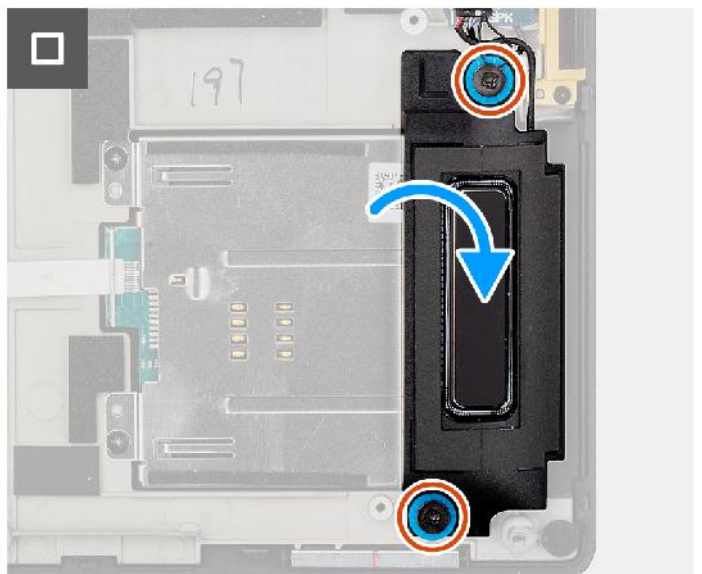
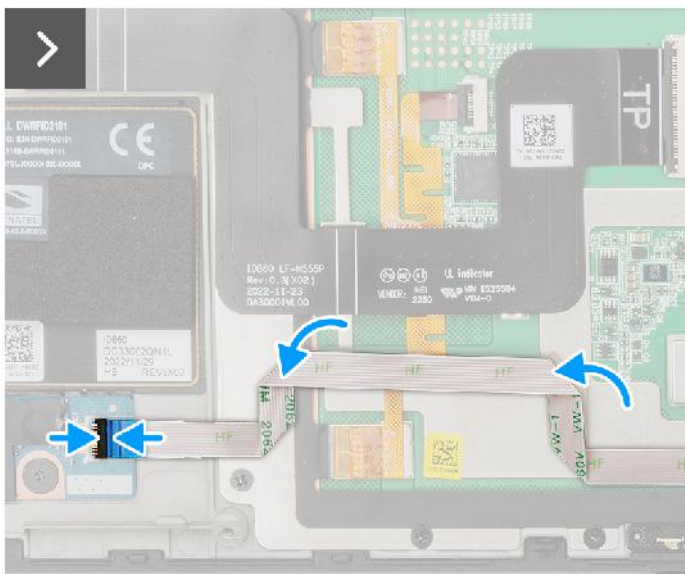
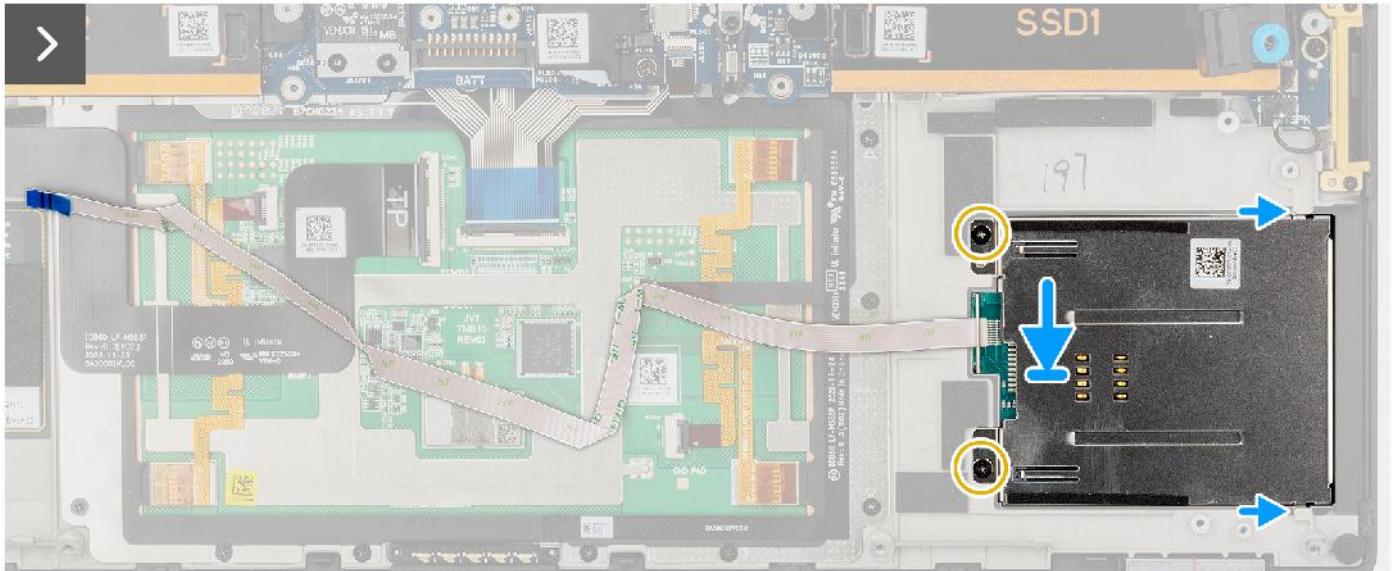
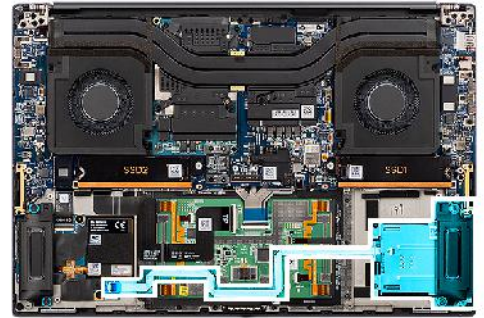

Steps

1. Align and place the smart-card reader with the smart-card reader FFC into the slot on the chassis.
2. Replace the two (M1.6x1.7) screws to secure the smart-card reader to the chassis.
3. Adhere the smart-card reader FFC on the palm-rest assembly.
4. Connect the smart-card reader FFC cable to the connector on the USH and SD card reader daughterboard.
5. Align and place the left speaker into the slot on the chassis.
6. Replace the two (M1.6x1.8) screws to secure the left speaker in place.

Next steps

1. Install the [Battery](#).
2. Install the [base cover](#).
3. Install the [SD card](#).
4. Follow the procedure in [After working inside your computer](#).

GPU card

Removing the GPU card

Prerequisites

1. Follow the procedure in [Before working inside your computer](#).
 -  **NOTE:** Ensure that your computer is in Service Mode. For more information see, step 6 in [Before working inside your computer](#).
2. Remove the [SD card](#).
3. Remove the [base cover](#).
4. Remove the [Battery](#).
5. Remove the [heatsink](#).

About this task

 **CAUTION:** The information in this removal section is intended for authorized service technicians only.

 **NOTE:** The following procedure is applicable for systems shipped with a GPU card only.

The following images indicate the location of the GPU card and provide a visual representation of the removal procedure.



4x
M1.4x4



4x
M2x4



4x
M1.6x4.5

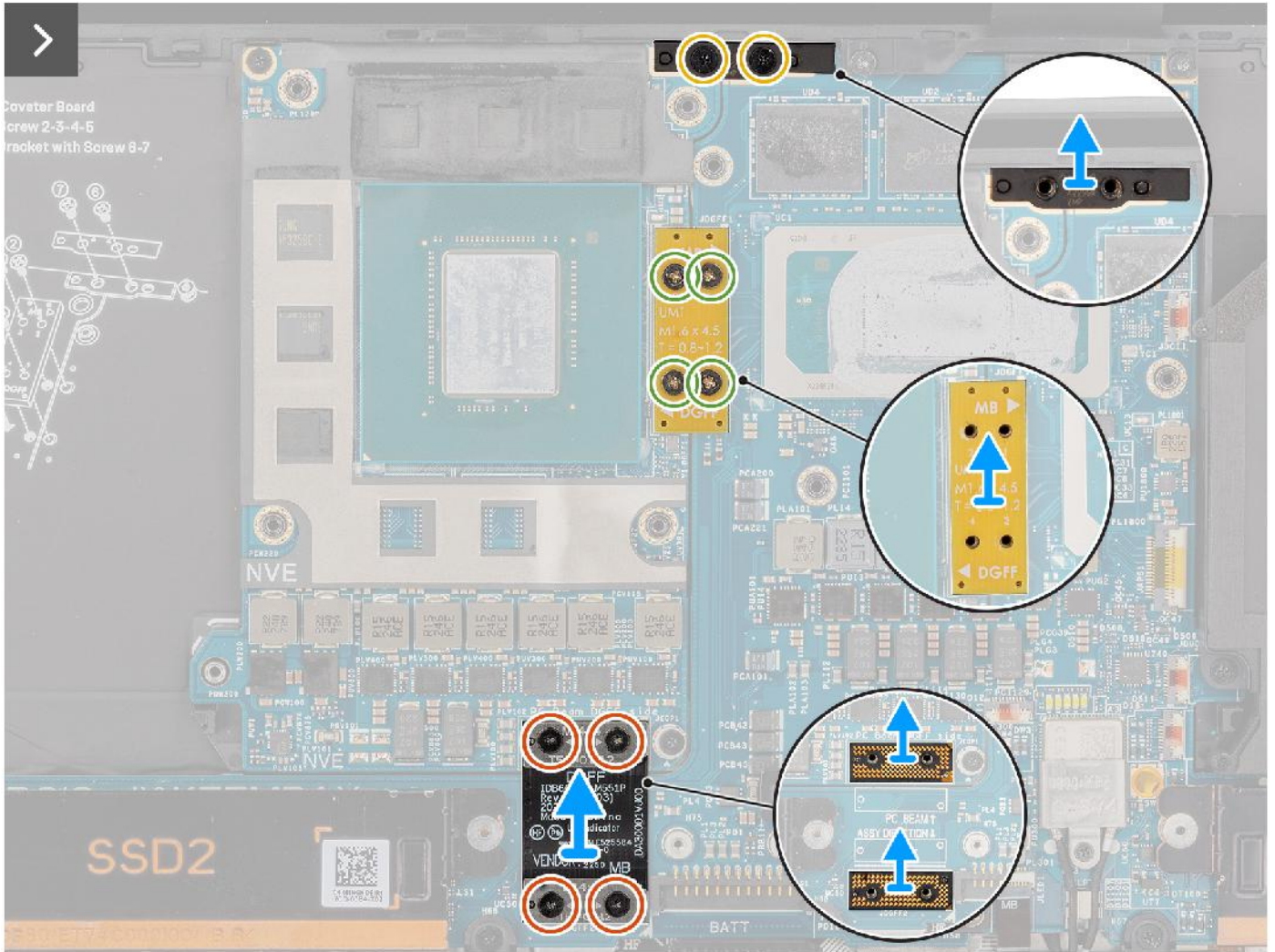
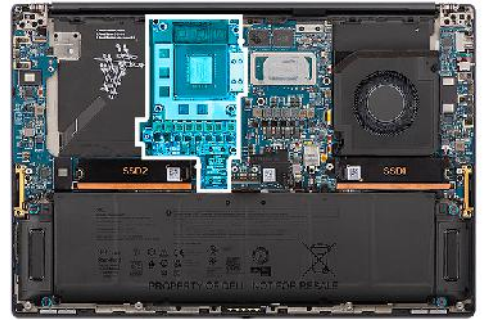

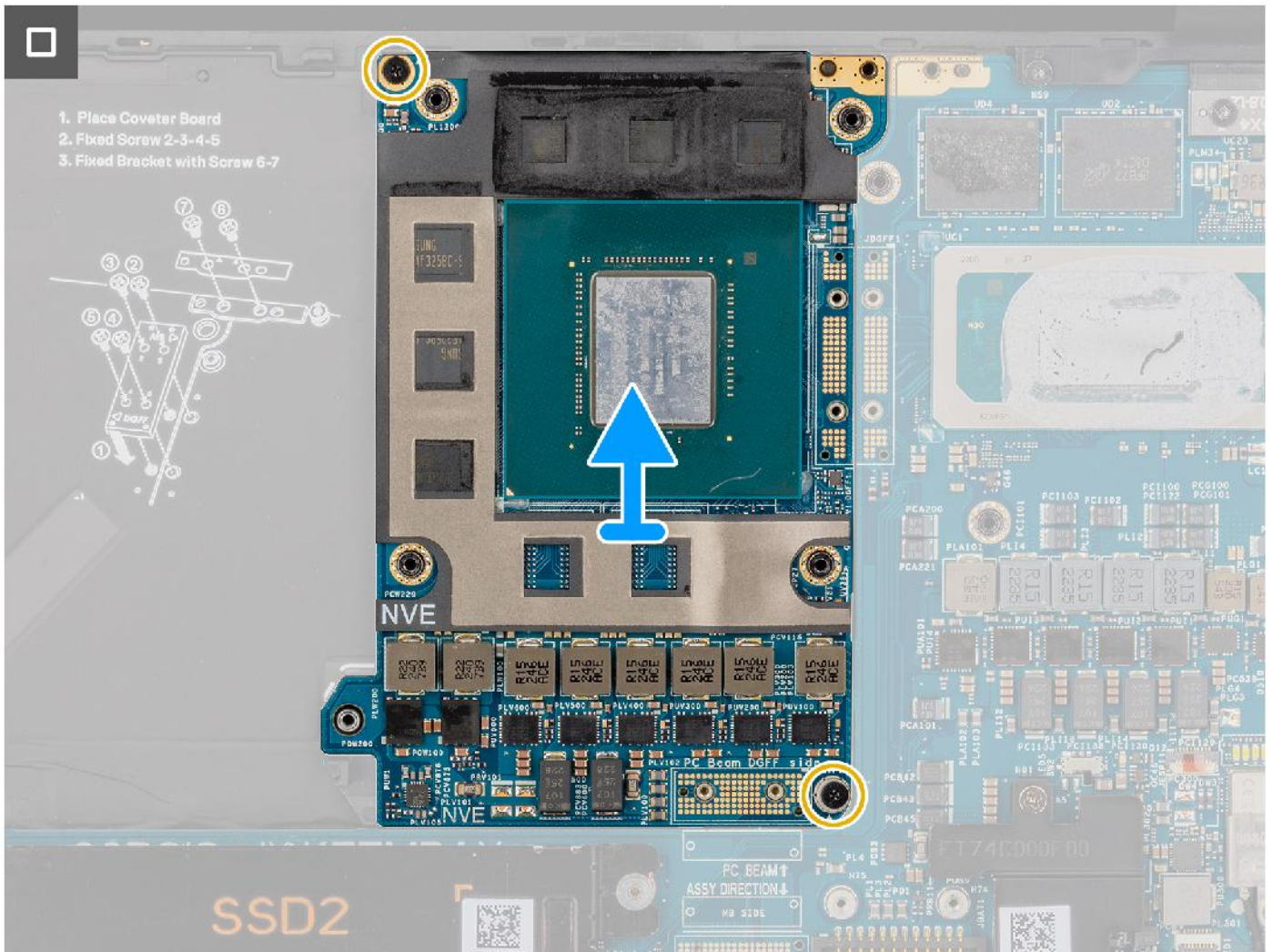

Steps

1. Remove the four (M1.4x4) T5 Torx screws sequentially as mentioned on the GPU card FPC that secure the GPU card FPC in place.
2. Remove the GPU card FPC from the system board.
3. Remove the two GPU card FPC imposter boards from the system board.

NOTE: The pins on the interposer board are very fragile. Avoid contact with the pins on the board, instead handle the board by lifting and holding from the edges or the sides.

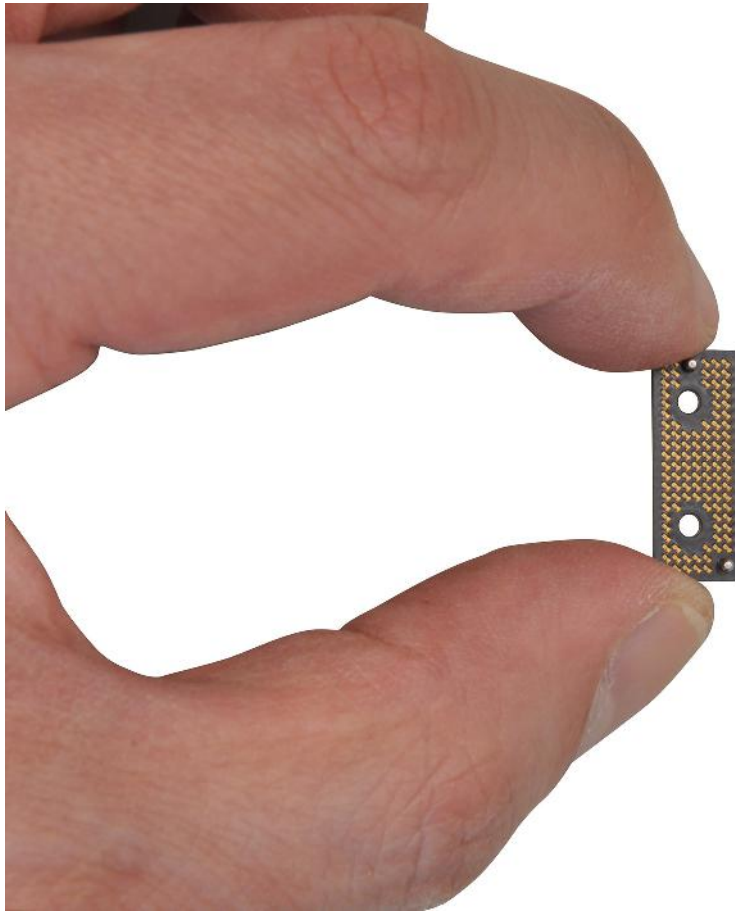

NOTE:

4. Remove the four (M1.6x4.5) screws that secure the GPU card bridge in place.
5. Remove the GPU card bridge from the system board.
6. Remove the two (M2x4) screws that secure the PC bridge bracket in place.
7. Remove the PC bridge bracket from the system board.
8. Remove the two (M2x4) screws that secure the GPU card in place.
9. Remove the GPU card from the system board.

Installing the GPU card

Prerequisites

If you are replacing a component, remove the existing component before performing the installation procedure.

About this task

 **CAUTION:** The information in this installation section is intended for authorized service technicians only.

 **NOTE:** The following procedure is applicable for systems shipped with a GPU card only.

The following image indicates the location of the GPU card and provides a visual representation of the installation procedure.



4x
M1.4x4



4x
M2x4



4x
M1.6x4.5

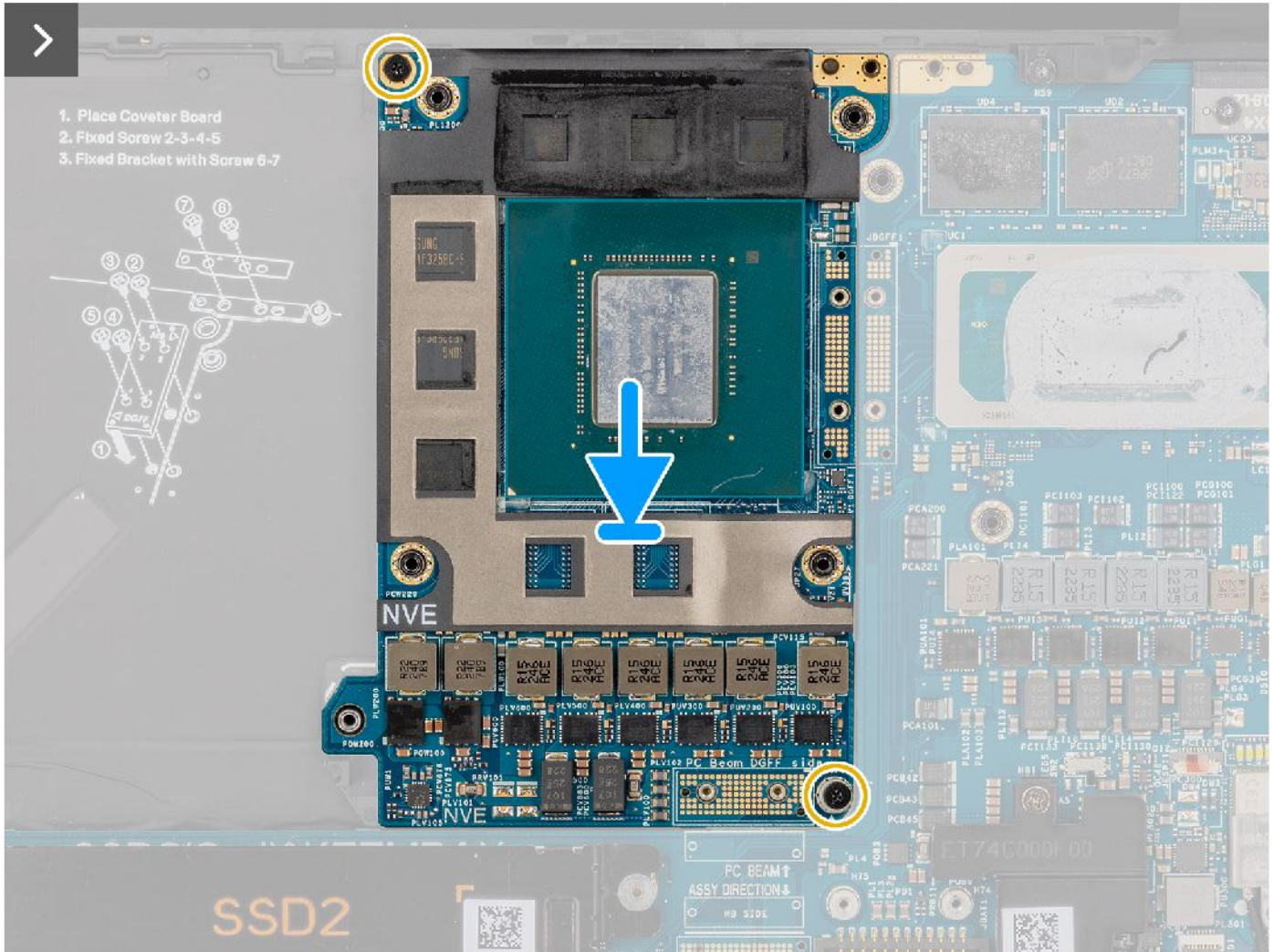
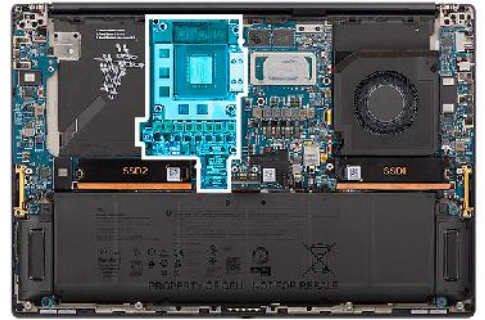

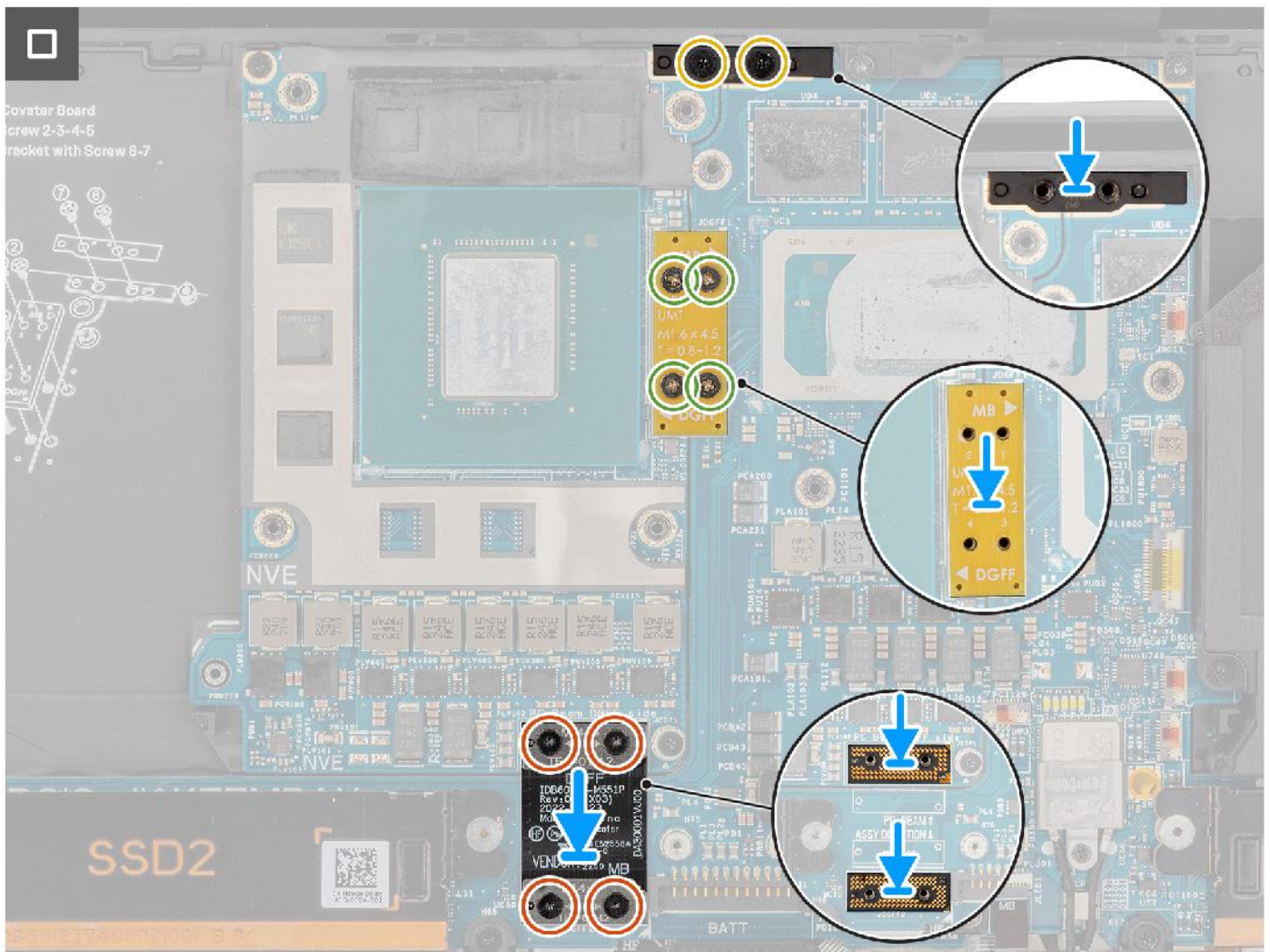

Steps

1. Align and place the GPU card into the slot on the system board.
2. Replace the two (M2x4) screws to secure the GPU card in place.
3. Align and place the PC bridge bracket into the slot on the system board.
4. Replace the two (M2x4) screws to secure the PC bridge bracket in place.
5. Align and place the GPU card bridge into the slot on the system board.
6. Replace the four (M1.6x4.5) screws to secure the GPU card bridge in place.
7. Align and place the two GPU card FPC imposter boards into the slot on the system board.
8. Align and place the GPU card FPC into the slot on the system board.
9. Replace the four (M1.4x4) T5 Torx screws sequentially as mentioned on the GPU card FPC to secure the GPU card FPC in place.

Next steps

1. Install the [heatsink](#).
2. Install the [Battery](#).
3. Install the [base cover](#).
4. Install the [SD card](#).
5. Follow the procedure in [After working inside your computer](#).

Dummy GPU card

Removing the dummy GPU card

Prerequisites

1. Follow the procedure in [Before working inside your computer](#).
 **NOTE:** Ensure that your computer is in Service Mode. For more information see, step 6 in [Before working inside your computer](#).
2. Remove the [SD card](#).
3. Remove the [base cover](#).
4. Remove the [Battery](#).
5. Remove the [heatsink](#).

About this task

 **CAUTION:** The information in this removal section is intended for authorized service technicians only.

 **NOTE:** The following procedure is applicable for systems shipped with an integrated system board only.

The following images indicate the location of the GPU card and provide a visual representation of the removal procedure.



4x
M2x4

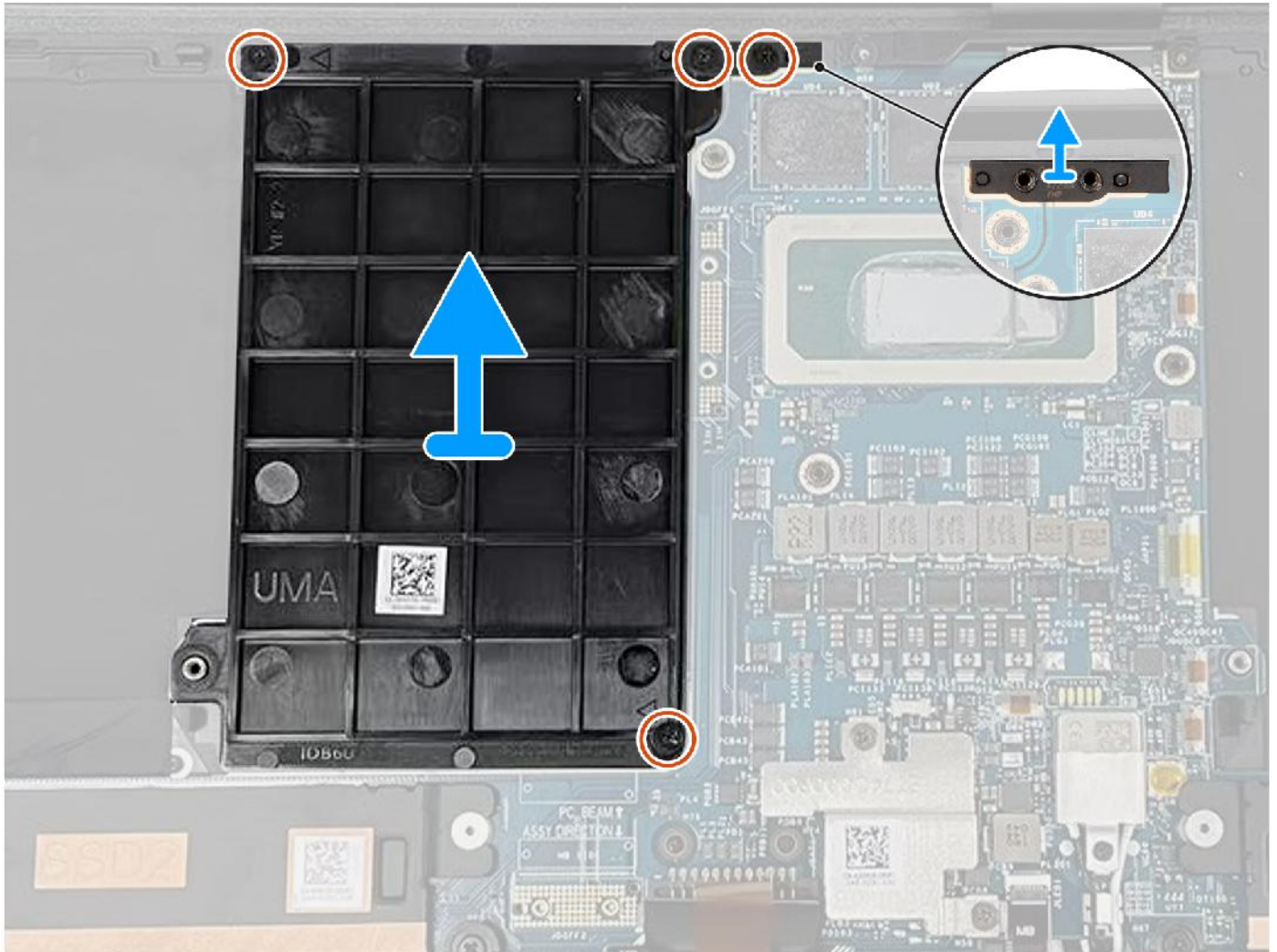

Steps

1. Remove the two (M2x4) screws that secure the PC bridge bracket in place.
2. Remove the PC bridge bracket from the system board.
3. Remove the two (M2x4) screws that secure the dummy GPU card in place.
4. Remove the dummy GPU card from the system board.

Installing the dummy GPU card

Prerequisites

If you are replacing a component, remove the existing component before performing the installation procedure.

About this task

NOTE: The following procedure is applicable for systems shipped with an integrated system board only.

The following image indicates the location of the GPU card and provides a visual representation of the installation procedure.



4x
M2x4

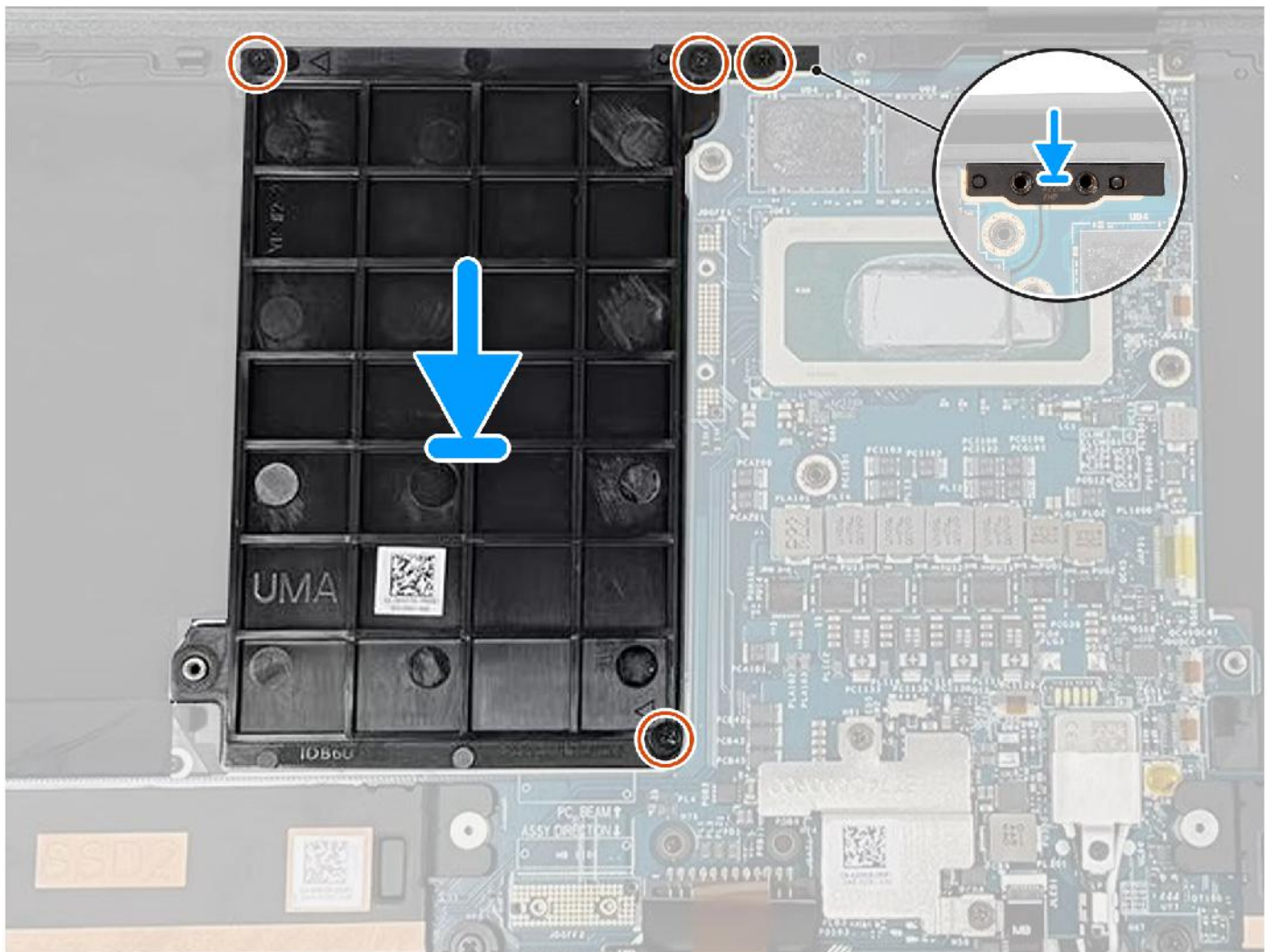
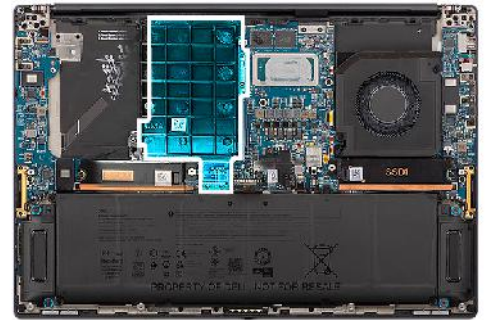

Steps

1. Align and place the dummy GPU card into the slot on the system board.
2. Replace the two (M2x4) screws to secure the dummy GPU card in place.
3. Align and place the PC bridge bracket into the slot on the system board.
4. Replace the two (M2x4) screws to secure the PC bridge bracket in place.

Next steps

1. Install the [heatsink](#).
2. Install the [Battery](#).
3. Install the [base cover](#).
4. Install the [SD card](#).
5. Follow the procedure in [After working inside your computer](#).

System board

Removing the system board

Prerequisites

1. Follow the procedure in [Before working inside your computer](#).
 **NOTE:** Ensure that your computer is in Service Mode. For more information see, step 6 in [Before working inside your computer](#).
2. Remove the [SD card](#).
3. Remove the [base cover](#).
4. Remove the [M.2 solid-state drive](#), for systems shipped with a solid-state drive.
5. Remove the [VPU card](#), for systems shipped with a VPU card.
6. Remove the [Battery](#).
7. Remove the [left fan](#).
8. Remove the [right fan](#).
9. Remove the [heatsink](#).

About this task

 **CAUTION:** The information in this removal section is intended for authorized service technicians only.

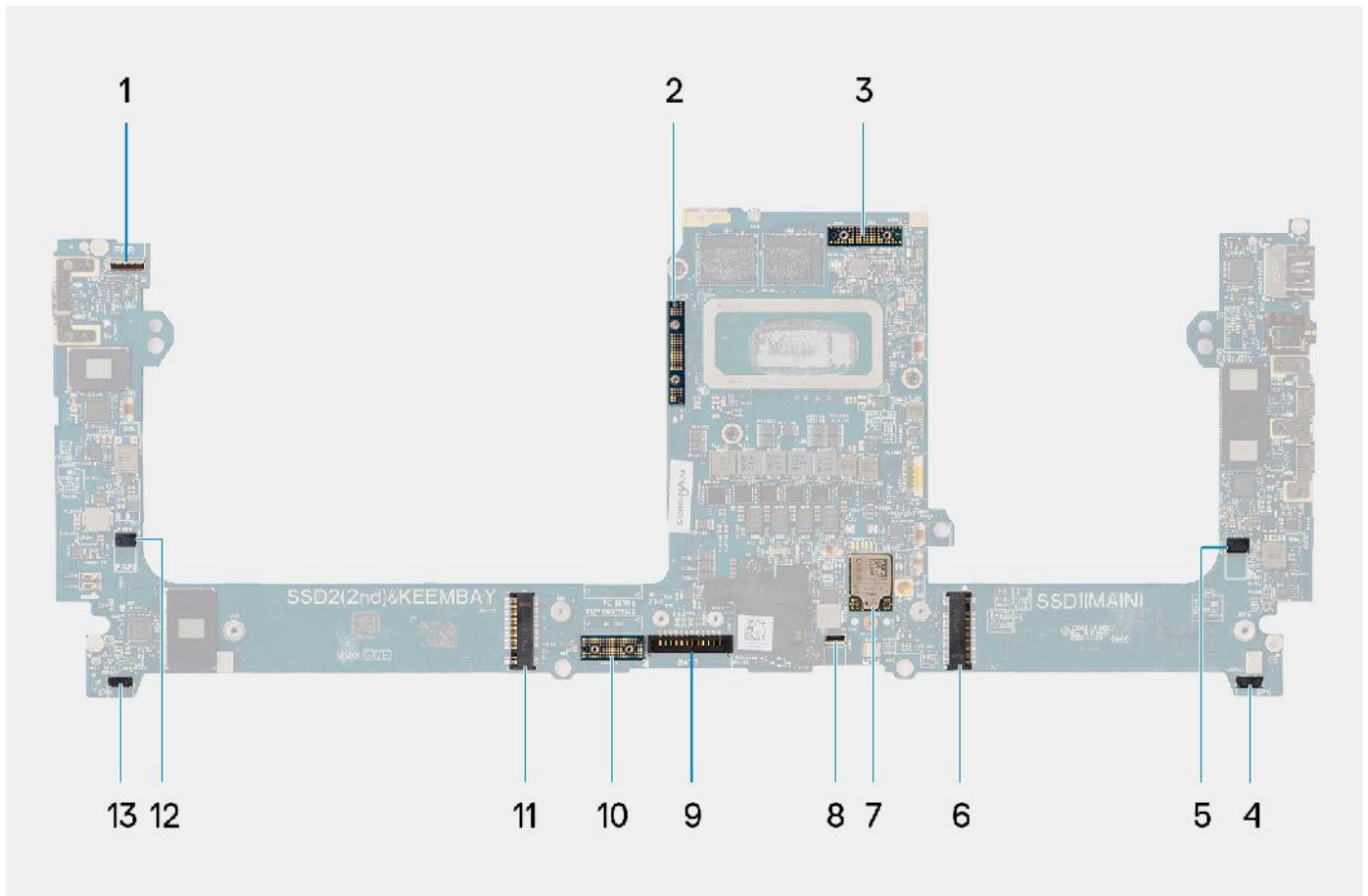

- | | |
|---|-------------------------------------|
| 1. Power button with fingerprint reader cable connector | 2. GPU card bridge |
| 3. Display FPC cable | 4. Left-speaker cable connector |
| 5. Left-fan cable connector | 6. Solid-state drive connector |
| 7. WLAN antennas connector | 8. Keyboard backlit cable connector |
| 9. Battery cable connector | 10. GPU card FPC imposter board |
| 11. Solid-state drive/VPU card connector | 12. Right-fan cable connector |
| 13. Right-speaker cable connector | |

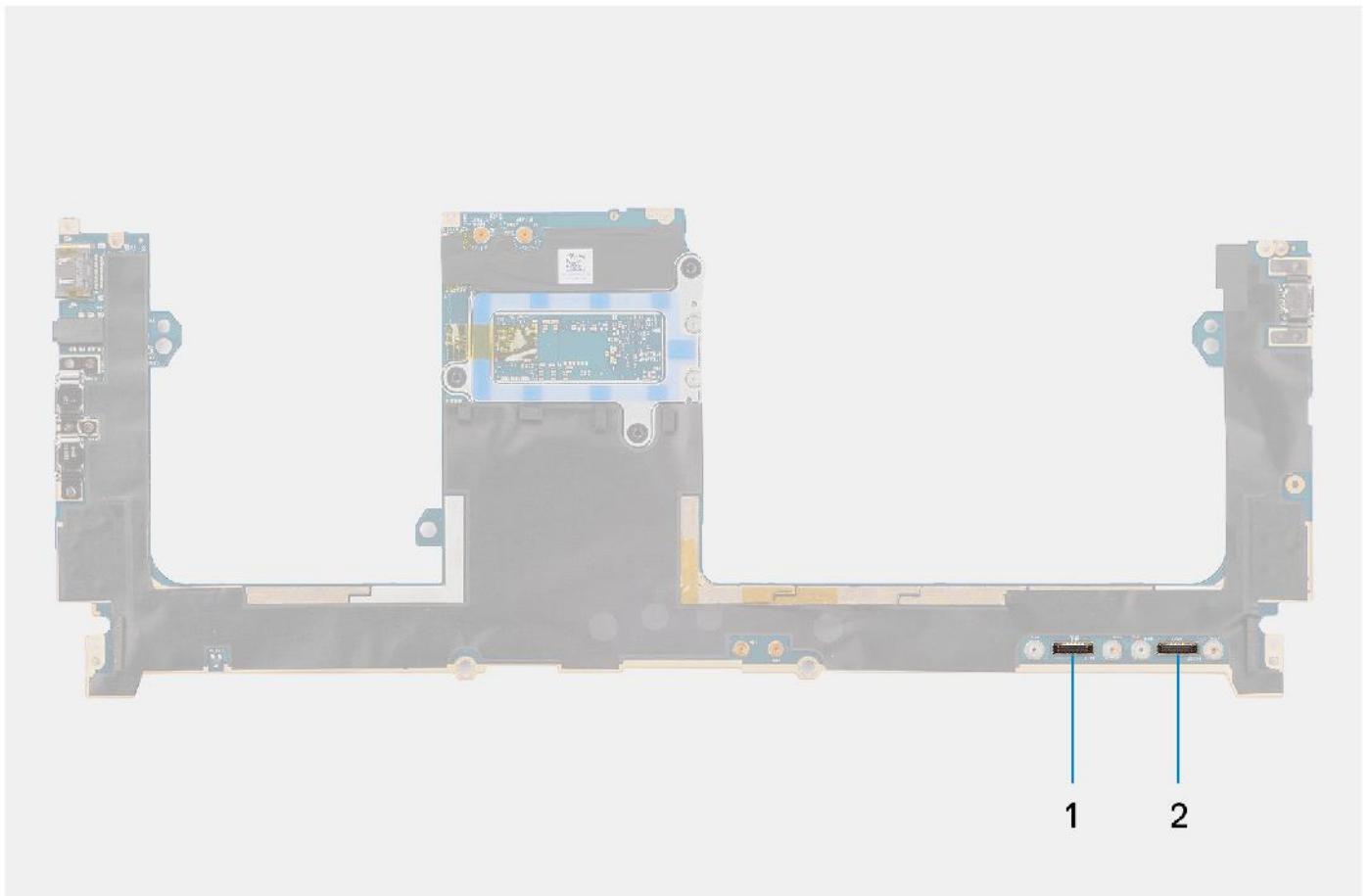

1. Touchpad cable connector
2. USB I/O board cable connector

The following images indicate the location of the system board assembly and provide a visual representation of the removal procedure.



4x
M1.4x4



1x



9x
M2x4

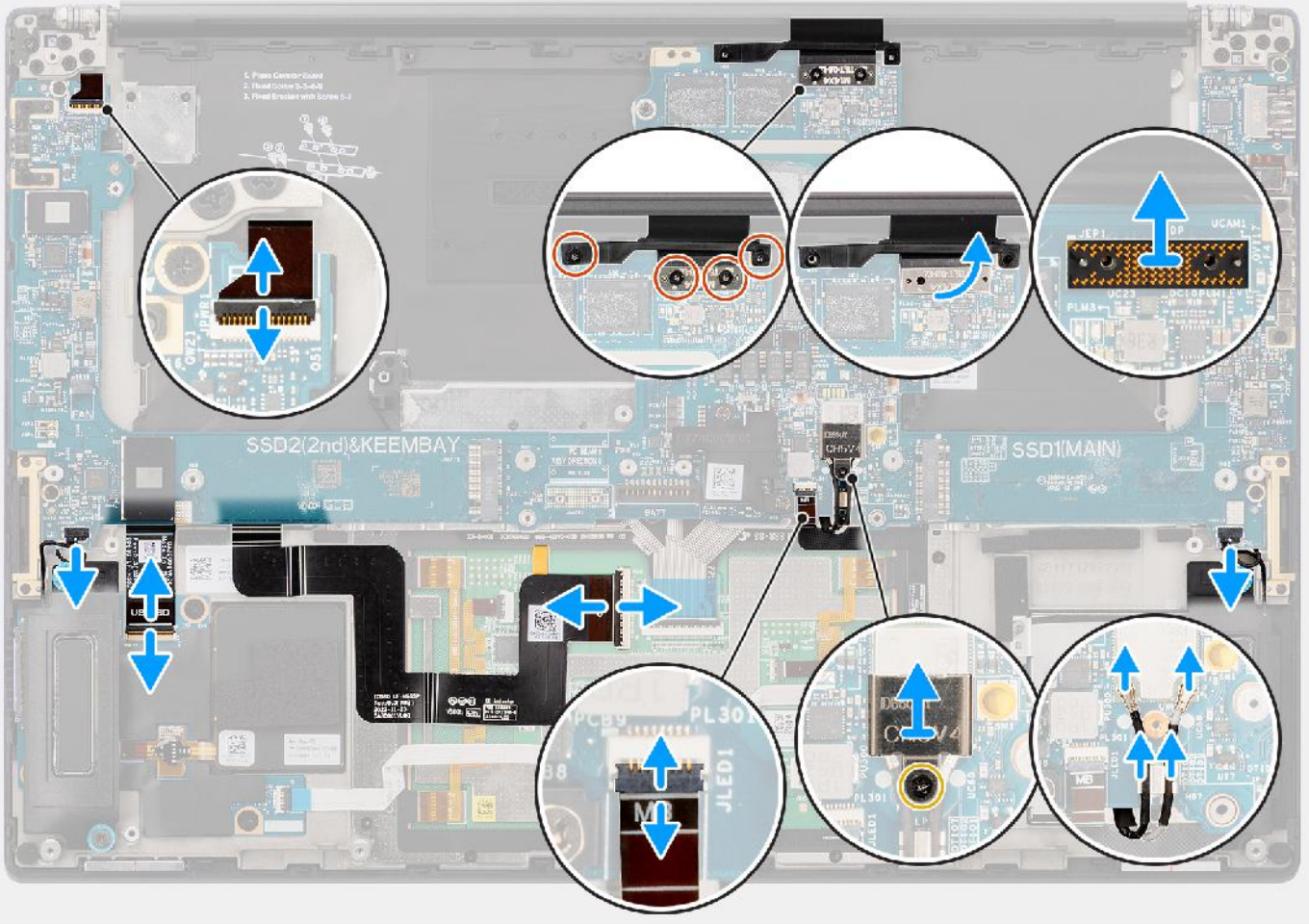
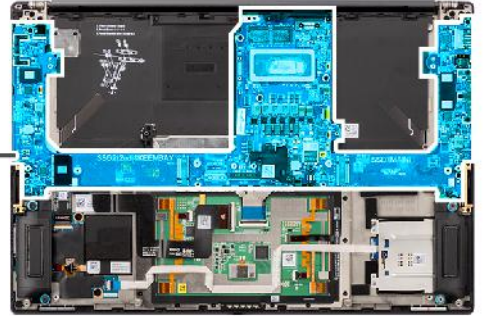

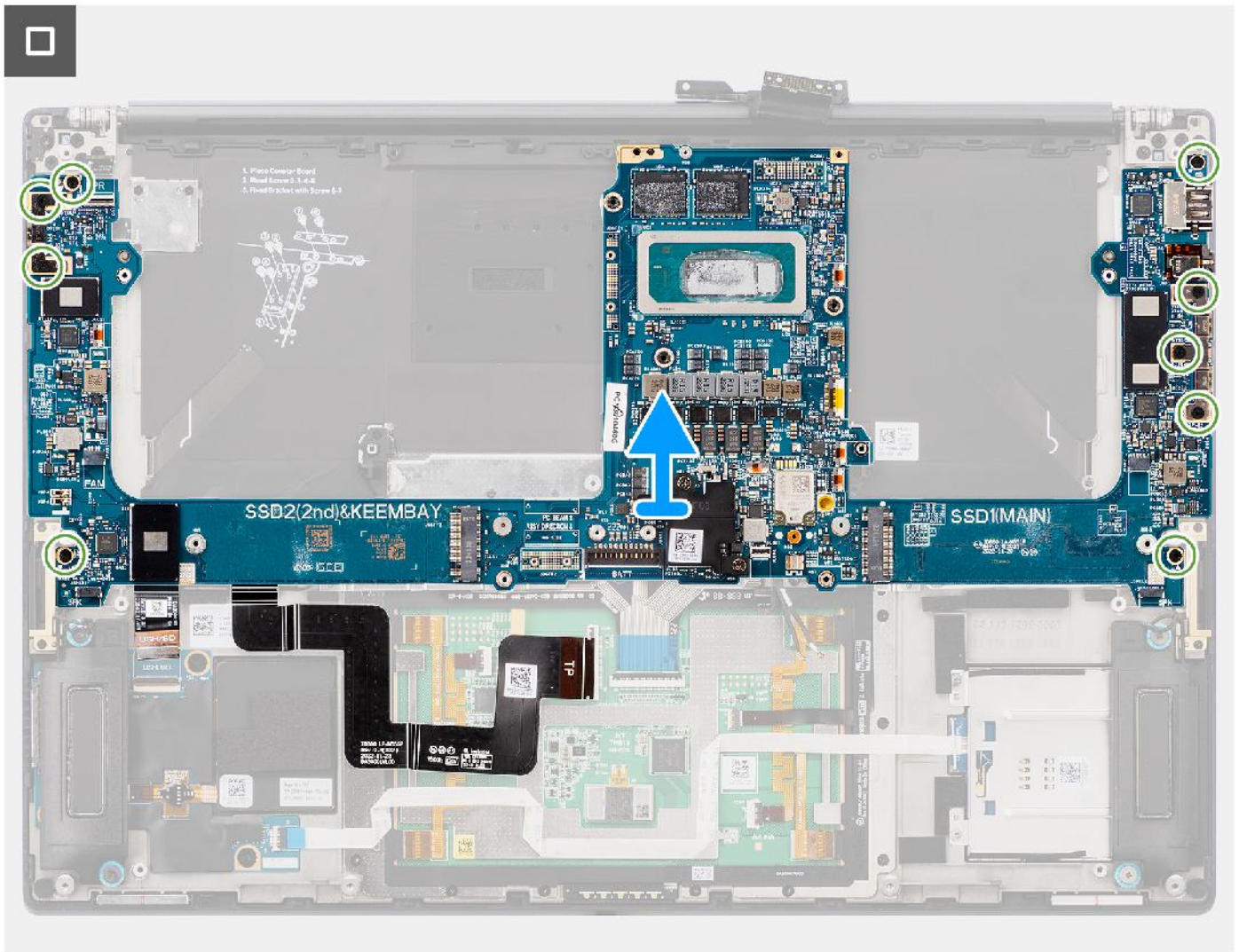

Steps

1. For systems shipped with a GPU card, remove the four (M1.4x4) T5 Torx screws that secure the GPU card FPC in place.
2. For systems shipped with a GPU card, remove the GPU card FPC from the system board.
3. For systems shipped with a GPU card, remove the two GPU card FPC imposter boards from the system board.
4. For systems shipped with a GPU card, remove the four (M1.6x4.5) screws that secure the GPU card bridge in place.
5. For systems shipped with a GPU card, remove the GPU card bridge from the system board.
6. For systems shipped with a WLAN card, loosen the captive screw that secures the WLAN bracket in place.
7. For systems shipped with a WLAN card, remove the WLAN bracket from the system board.
8. For systems shipped with a WLAN card, disconnect the antenna cables from the connectors on the WLAN module.
9. For systems shipped with a WLAN card, unroute the antenna cables from the metal clips on the system board.
10. Remove the two (M1.4x4) screws that secure the display FPC cover in place.
11. Flip open the display FPC cover.
12. Remove the two (M1.4x4) T5 Torx screws that secure the display FPC in place.
13. Disconnect the display FPC cable from the connector on the system board.
14. Remove the display FPC imposter board from the system board.

i NOTE: Technicians must remove the interposer board immediately after disconnecting the display FPC to prevent the board from falling out of the system during subsequent removal procedures. The pins on the interposer board are very fragile. Avoid contact with the pins on the board, instead handle the board by lifting and holding from the edges or the sides.

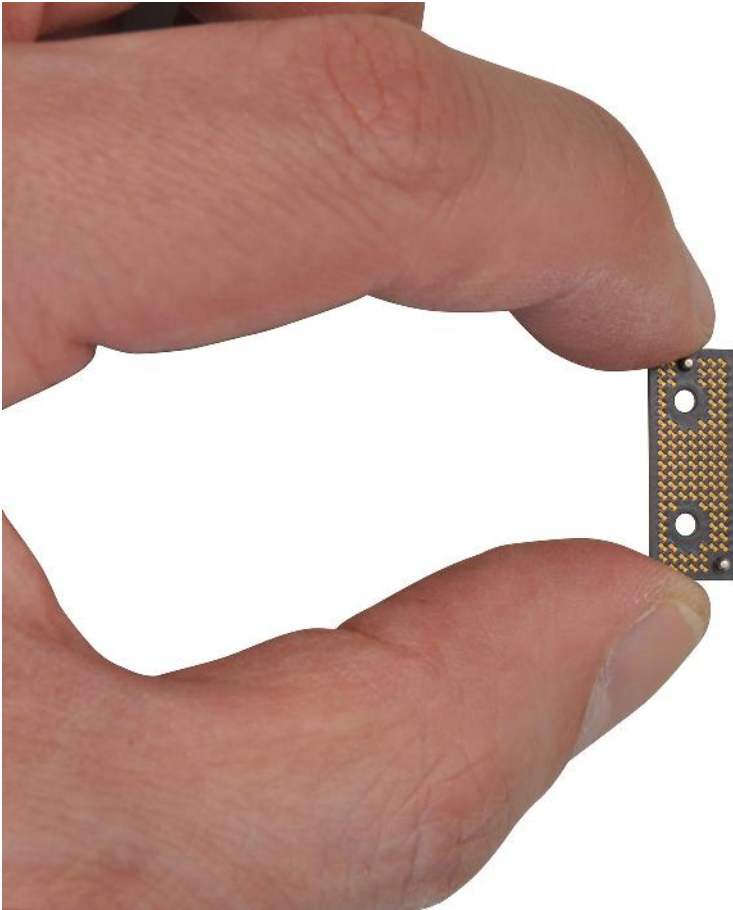

15. For systems shipped without a USH module, disconnect the SD-card reader daughterboard FPC cable from the connector on the SD-card reader daughterboard.
16. For systems shipped with a USH module, disconnect the USH and SD-card reader daughterboard FPC cable from the connector on the USH and SD-card reader daughterboard.
17. Disconnect the touchpad FPC cable from the connector on the touchpad module.
18. Peel the SD-card reader daughterboard FPC/USH and SD-card reader daughterboard FPC cable and touchpad FPC cable from the palm-rest assembly.
19. Disconnect the power button with fingerprint reader FPC cable, right speaker cable, front LED FPC cable, and left speaker cable from the connectors on the system board.
20. Remove the two (M2x4) screws that secure the PC bridge support bracket in place.
21. Remove the PC bridge support bracket from the system board.
22. Remove the nine (M2x4) screws that secure the system board to the palm-rest assembly.
23. Remove the system board off the chassis.

i NOTE: Replacement of the system board requires further removal of the touchpad FPC and SD-Card reader daughterboard FPC/USH and SD-Card reader daughterboard FPC. Refer disassembly procedures of touchpad and SD card reader daughterboard FPC/USH and SD-card reader daughterboard FPC for more information.

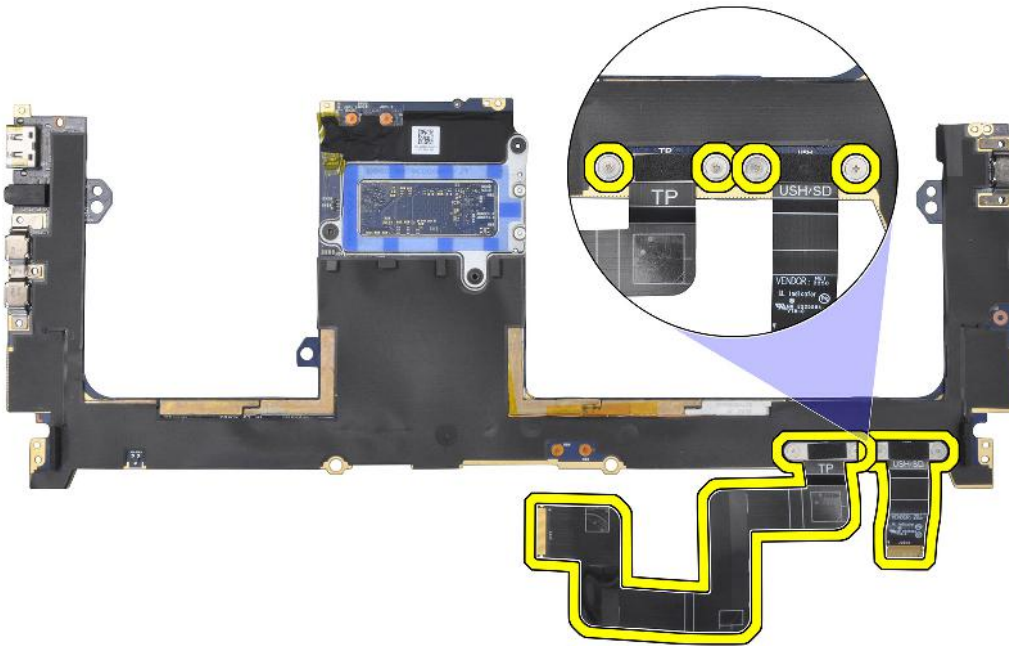

Installing the system board

Prerequisites

If you are replacing a component, remove the existing component before performing the installation procedure.

About this task

CAUTION: The information in this installation section is intended for authorized service technicians only.

The following image indicates the location of the system board and provides a visual representation of the installation procedure.

NOTE: Replacement of the system board requires further removal of the touchpad FPC and SD Card reader daughter board FPC/USH and SD Card reader daughter board FPC. Refer disassembly procedures of touchpad and SD card reader daughterboard FPC/USH and SD card reader daughterboard FPC for more information.

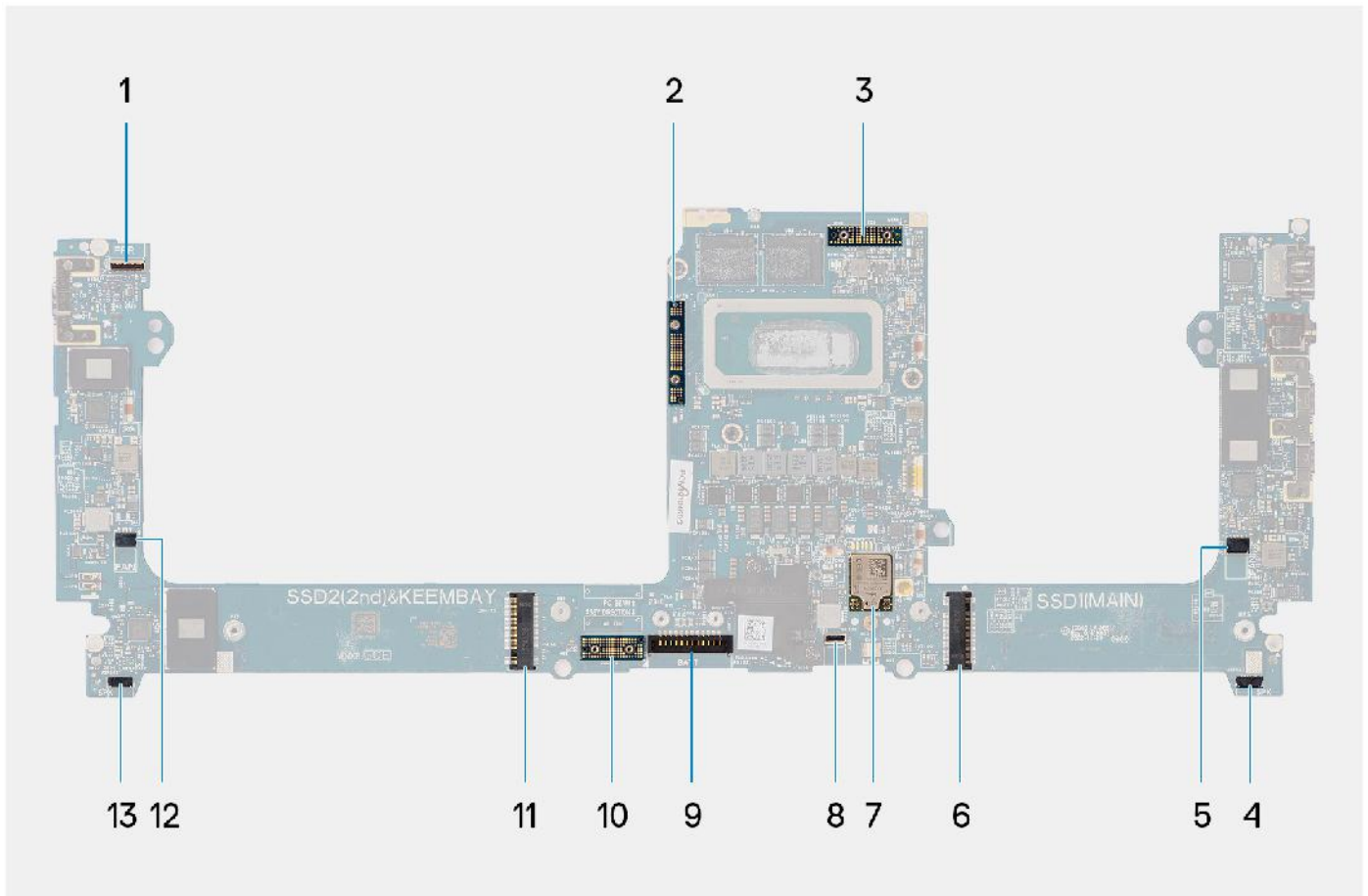

- | | |
|---|-------------------------------------|
| 1. Power button with fingerprint reader cable connector | 2. GPU card bridge |
| 3. Display FPC cable | 4. Left-speaker cable connector |
| 5. Left-fan cable connector | 6. Solid-state drive connector |
| 7. WLAN antennas connector | 8. Keyboard backlit cable connector |
| 9. Battery cable connector | 10. GPU card FPC imposter board |
| 11. Solid-state drive/VPU card connector | 12. Right-fan cable connector |
| 13. Right-speaker cable connector | |

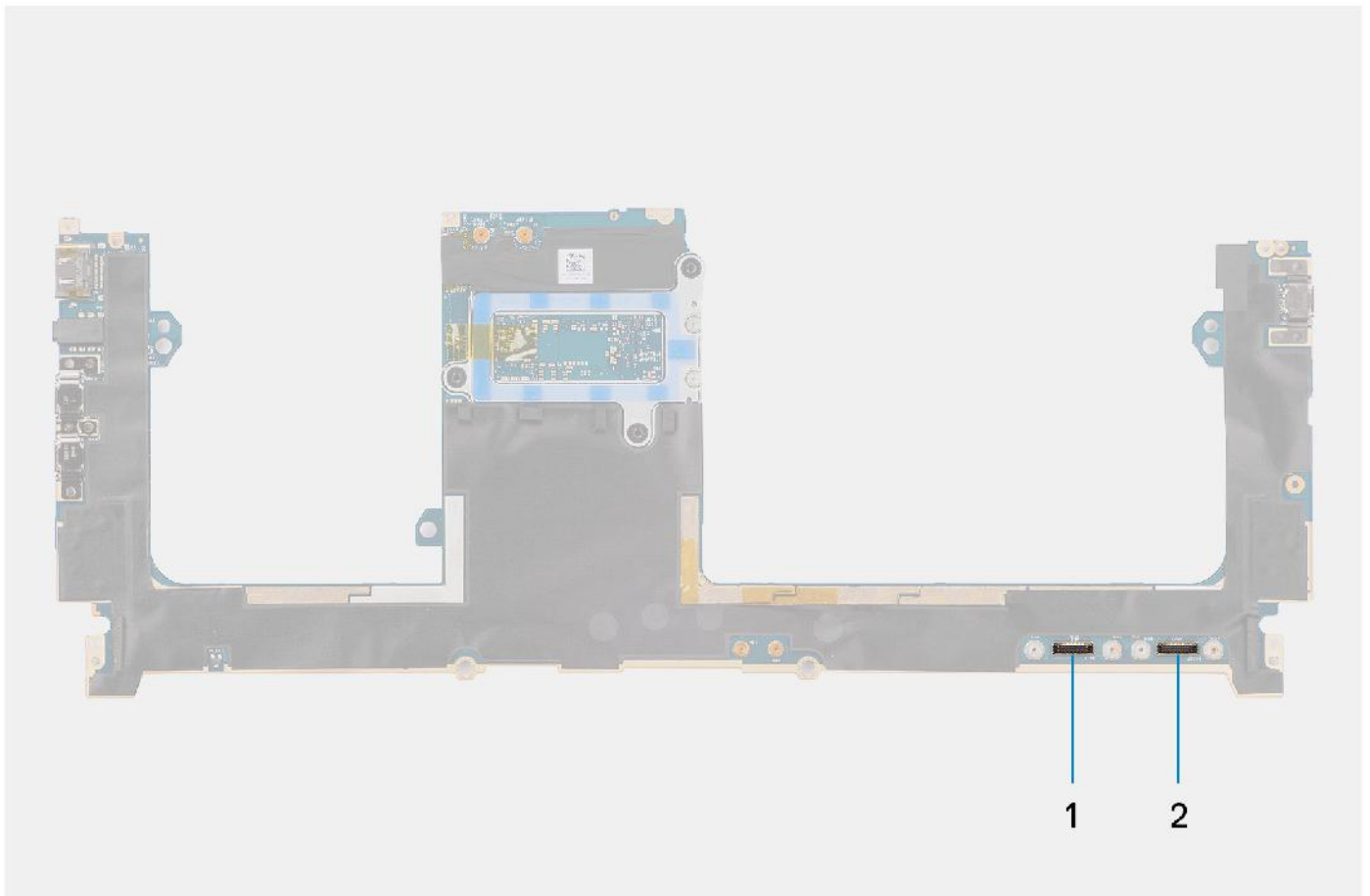

1. Touchpad cable connector
2. USB I/O board cable connector



4x
M1.4x4



1x



9x
M2x4

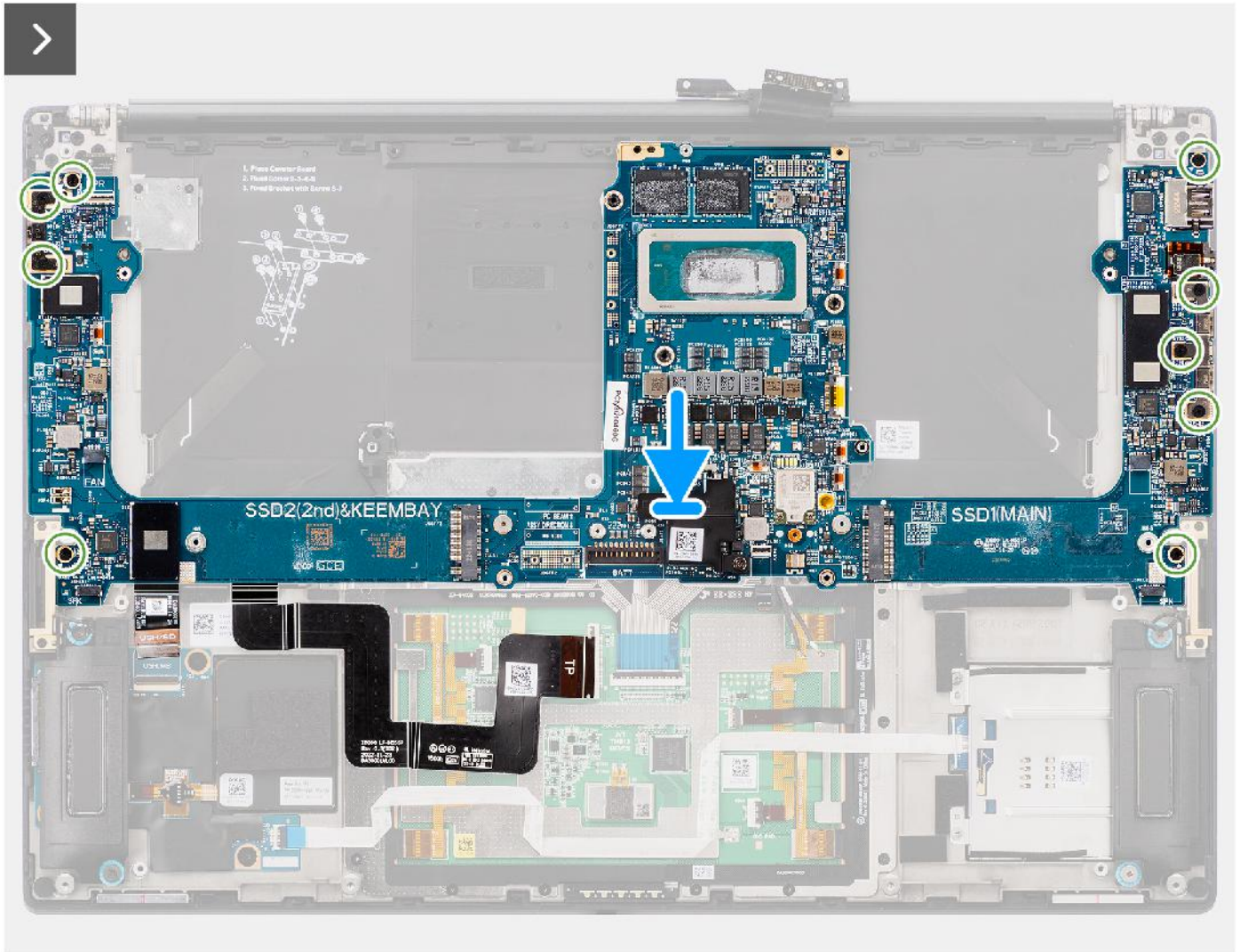

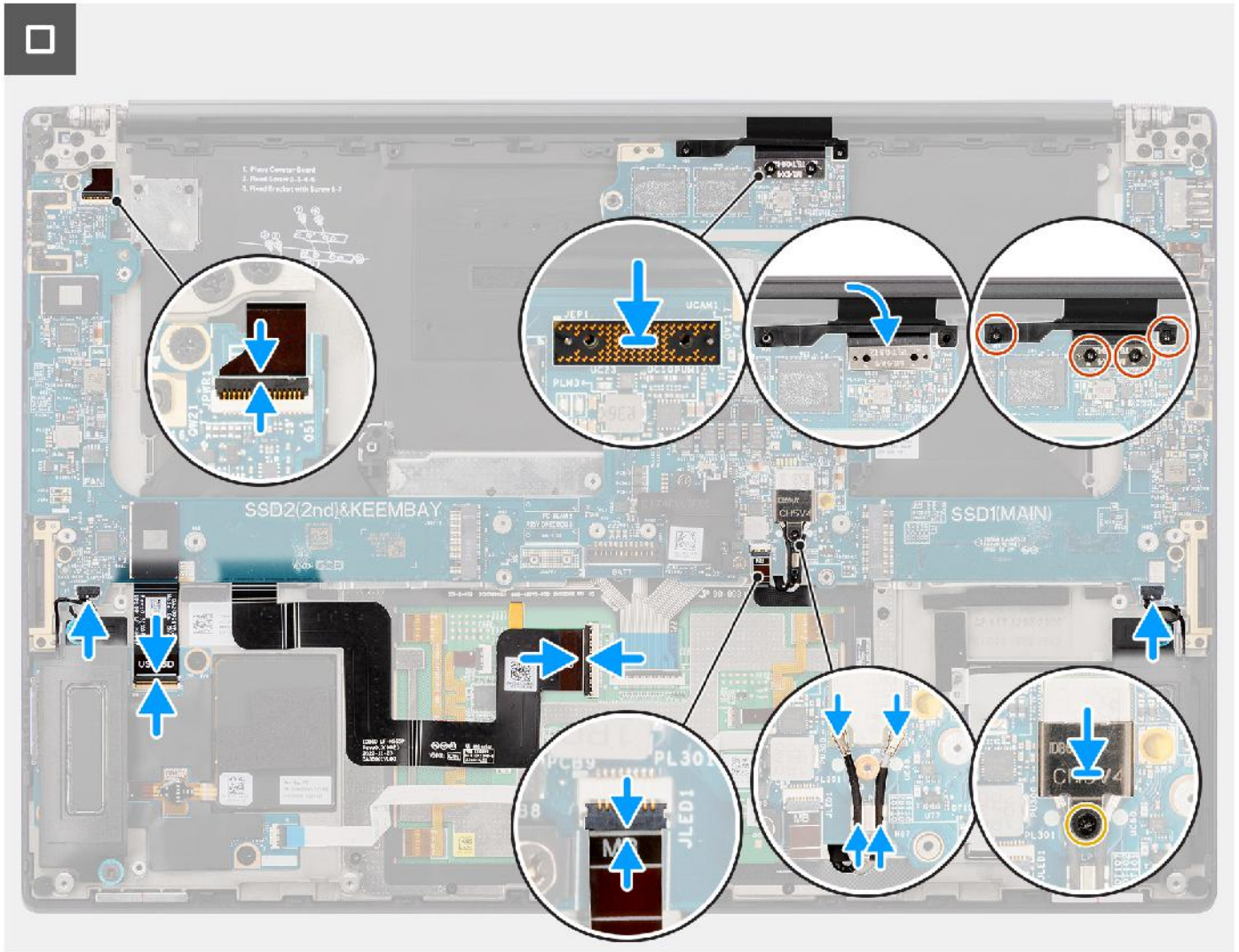

Steps

1. Align and place the system board on the palm-rest assembly.
2. Replace the nine (M2x4) screws to secure the system board to the palm-rest assembly.
3. Align and place the PC bridge support bracket on the system board.
4. Replace the two (M2x4) screws to secure the PC bridge support bracket in place.
5. Connect the power button with fingerprint reader FPC cable, right speaker cable, front LED FPC cable, and left speaker cable to the connectors on the system board.
6. Adhere the SD-card reader daughterboard FPC/USH and SD-card reader daughterboard FPC cable and touchpad FPC cable on the palm-rest assembly.
7. Connect the touchpad FPC cable to the connector on the touchpad module.
8. For systems shipped with a USH module, connect the USH and SD-card reader daughterboard FPC cable to the connector on the USH and SD-card reader daughterboard.
9. For systems shipped without a USH module, connect the SD-card reader daughterboard FPC cable to the connector on the SD-card reader daughterboard.
10. Align and place the display FPC imposter board on the system board.

NOTE: The pins on the interposer board are very fragile. Avoid contact with the pins on the board, instead handle the board by lifting and holding from the edges or the sides.
11. Connect the display FPC cable to the connector on the system board.
12. Replace the two (M1.4x4) T5 Torx screws to secure the display FPC in place.
13. Flip close the display FPC cover.

14. Replace the two (M1.4x4) screws to secure the display FPC cover in place.
15. For systems shipped with a WLAN card, route the antenna cables through the metal clips on the system board.
16. For systems shipped with a WLAN card, connect the antenna cables to the connectors on the WLAN module.
17. For systems shipped with a WLAN card, align and place the WLAN bracket on the system board.
18. For systems shipped with a WLAN card, tighten the captive screw to secure the WLAN bracket in place.
19. For systems shipped with a GPU card, align and place the GPU card bridge on the system board.
20. For systems shipped with a GPU card, replace the four (M1.6x4.5) screws to secure the GPU card bridge in place.
21. For systems shipped with a GPU card, align and place the two GPU card FPC imposter boards on the system board.
22. For systems shipped with a GPU card, align and place the GPU card FPC from the system board.
23. For systems shipped with a GPU card, replace the four (M1.4x4) T5 Torx screws to secure the GPU card FPC in place.

Next steps

1. Install the [heatsink](#).
2. Install the [right fan](#).
3. Install the [left fan](#).
4. Install the [Battery](#).
5. Install the [VPU card](#), for systems shipped with a VPU card.
6. Install the [M.2 solid-state drive](#), for systems shipped with a solid-state drive.
7. Install the [base cover](#).
8. Install the [SD card](#).
9. Follow the procedure in [After working inside your computer](#).

Speakers

Removing the speakers

Prerequisites

1. Follow the procedure in [Before working inside your computer](#).
 -  **NOTE:** Ensure that your computer is in Service Mode. For more information see, step 6 in [Before working inside your computer](#).
2. Remove the [SD card](#).
3. Remove the [base cover](#).
4. Remove the [M.2 solid-state drive](#), for systems shipped with a solid-state drive.
5. Remove the [VPU card](#), for systems shipped with a VPU card.
6. Remove the [Battery](#).
7. Remove the [left fan](#).
8. Remove the [right fan](#).
9. Remove the [heatsink](#).
10. Remove the [system board](#).

About this task

 **CAUTION:** The information in this removal section is intended for authorized service technicians only.

The following images indicate the location of the speakers and provide a visual representation of the removal procedure.



4x
M1.6x1.8

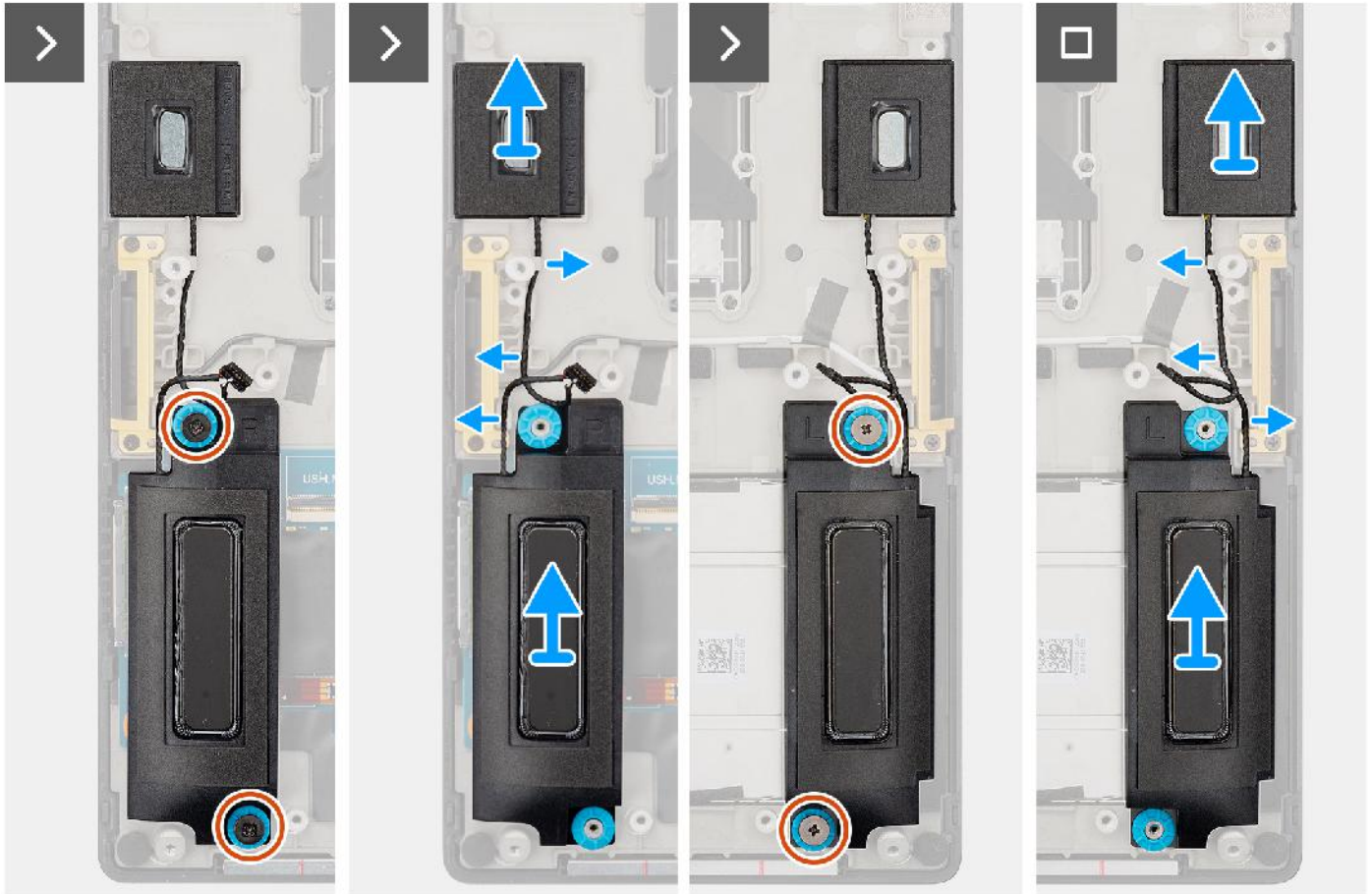
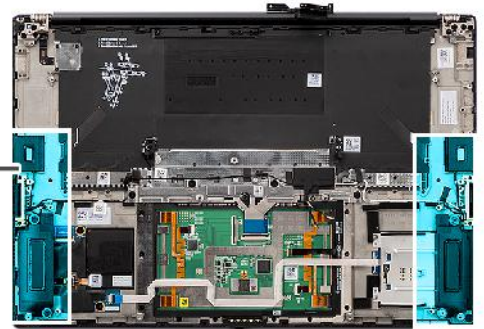
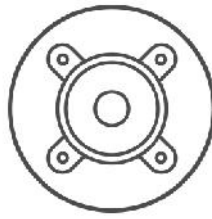

Steps

1. Remove the left and right tweeter speakers from their slots on the computer.
2. Unroute the left and right tweeter speaker cables from the routing guides on the system board.
3. Remove the four (M1.6x1.8) screws that secure the left and right speakers in place.
4. Lift the left and right speakers off the computer.

Installing the speakers

Prerequisites

If you are replacing a component, remove the existing component before performing the installation procedure.

About this task

 **CAUTION:** The information in this installation section is intended for authorized service technicians only.

The following image indicates the location of the speakers and provides a visual representation of the installation procedure.



4x
M1.6x1.8

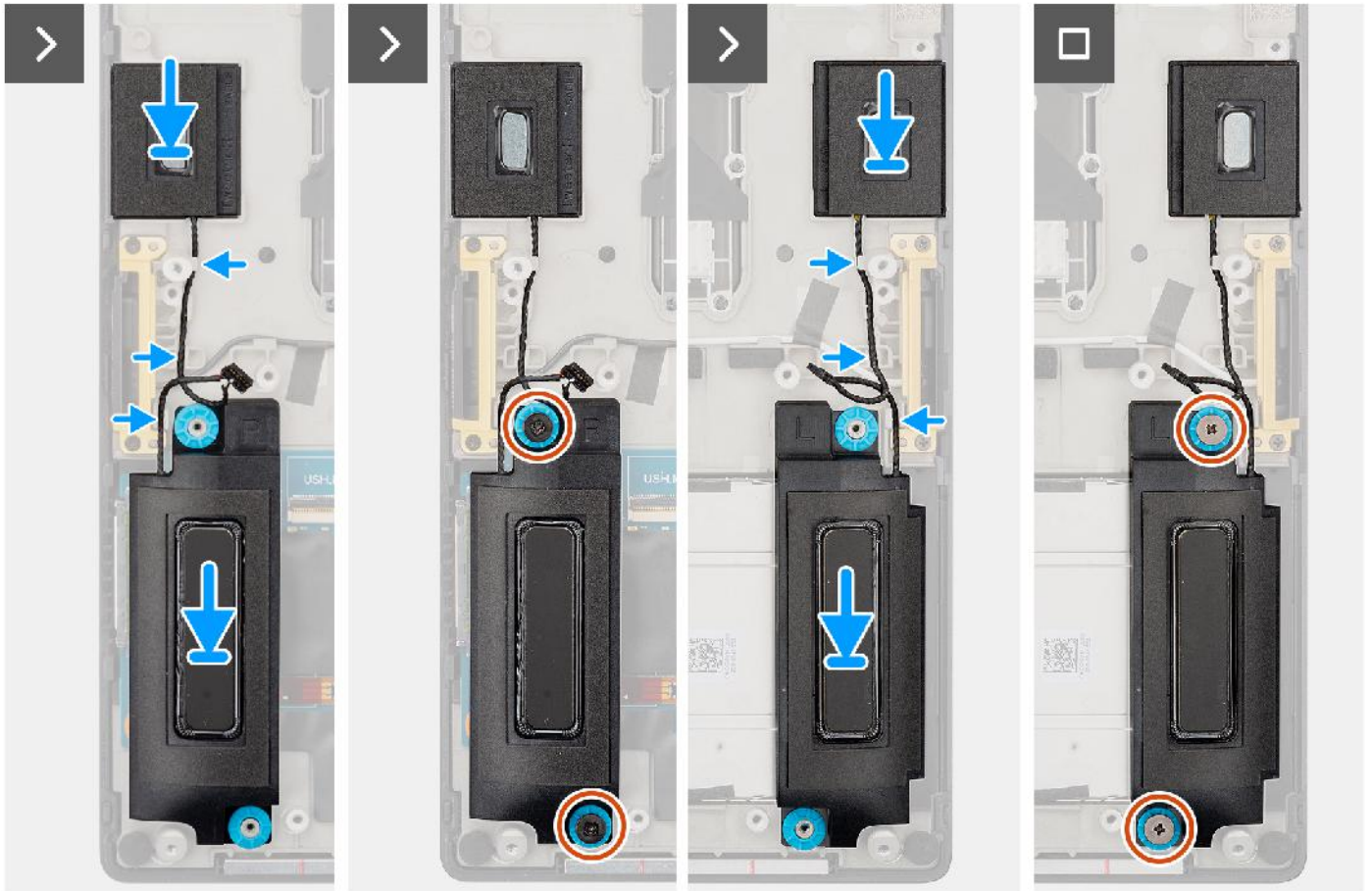
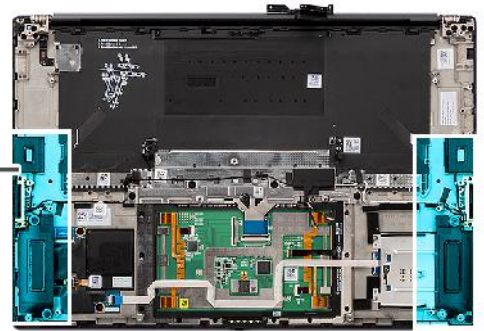
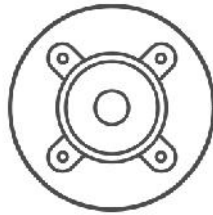

Steps

1. Align and place the left and right speakers into the slot on the computer.
2. Route the left and right tweeter speaker cables through the routing guides on the system board.
3. Replace the four (M1.6x1.8) screws to secure the left and right speakers in place.

Next steps

1. Install the [system board](#).
2. Install the [heatsink](#).
3. Install the [right fan](#).
4. Install the [left fan](#).
5. Install the [Battery](#).
6. Install the [VPU card](#), for systems shipped with a VPU card.
7. Install the [M.2 solid-state drive](#), for systems shipped with a solid-state drive.
8. Install the [base cover](#).

9. Install the [SD card](#).
10. Follow the procedure in [After working inside your computer](#).

Haptics trackpad FPC

Removing the touchpad FPC

 **CAUTION:** The information in this section is intended for authorized service technicians only.

Prerequisites

1. Follow the procedure in [Before working inside your computer](#).
 -  **NOTE:** Ensure that your computer is in Service Mode. For more information see, step 6 in [Before working inside your computer](#).
2. Remove the [SD card](#).
3. Remove the [base cover](#).
4. Remove the [M.2 solid-state drive](#), for systems shipped with a solid-state drive.
5. Remove the [VPU card](#), for systems shipped with a VPU card.
6. Remove the [Battery](#).
7. Remove the [left fan](#).
8. Remove the [right fan](#).
9. Remove the [heatsink](#).
10. Remove the [system board](#).

About this task

 **CAUTION:** The information in this removal section is intended for authorized service technicians only.

The following images indicate the location of the touchpad FPC and provide a visual representation of the removal procedure.



2x
M1.4x1.2

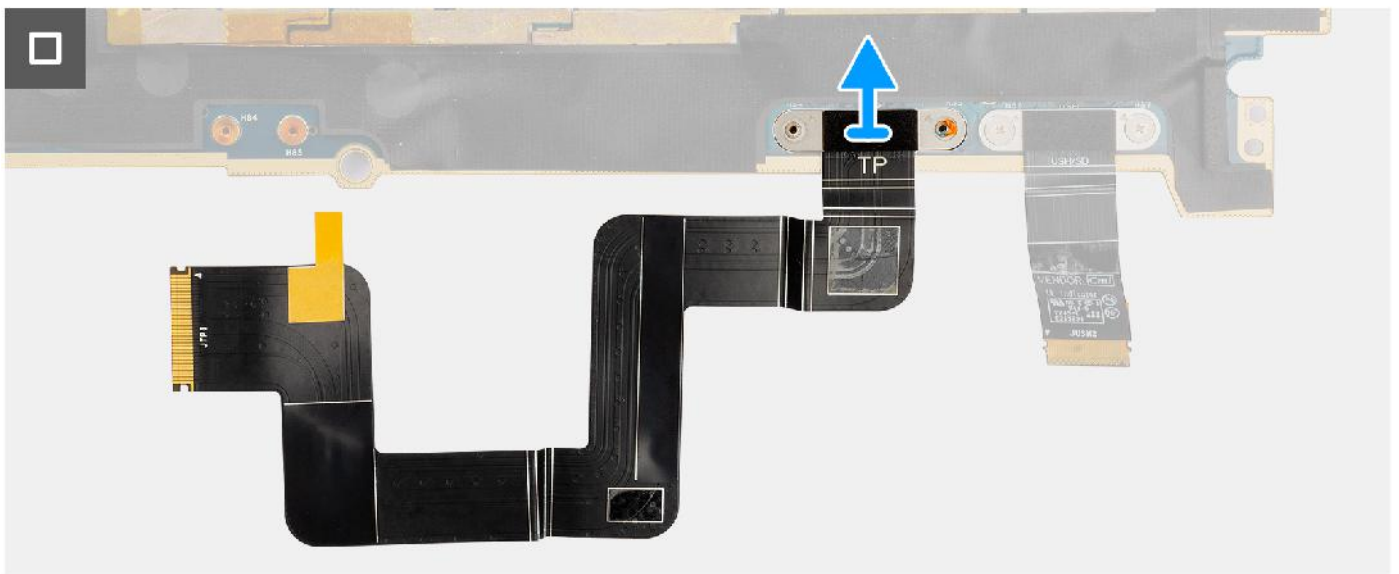
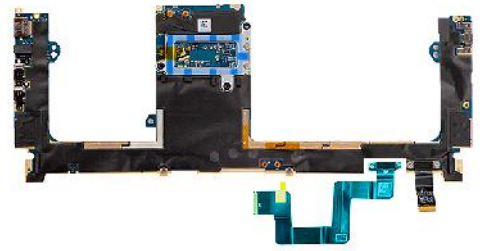

Steps

1. Remove the two screws (M1.4x1.2) that secure the touchpad FPC to the system board.
2. Disconnect and remove the touchpad FPC from the system board.

Installing the touchpad FPC

Prerequisites

If you are replacing a component, remove the existing component before performing the installation process.

About this task

 **CAUTION: The information in this installation section is intended for authorized service technicians only.**

The following images indicate the location of the touchpad FPC and provide a visual representation of the installation procedure.



2x
M1.4x1.2

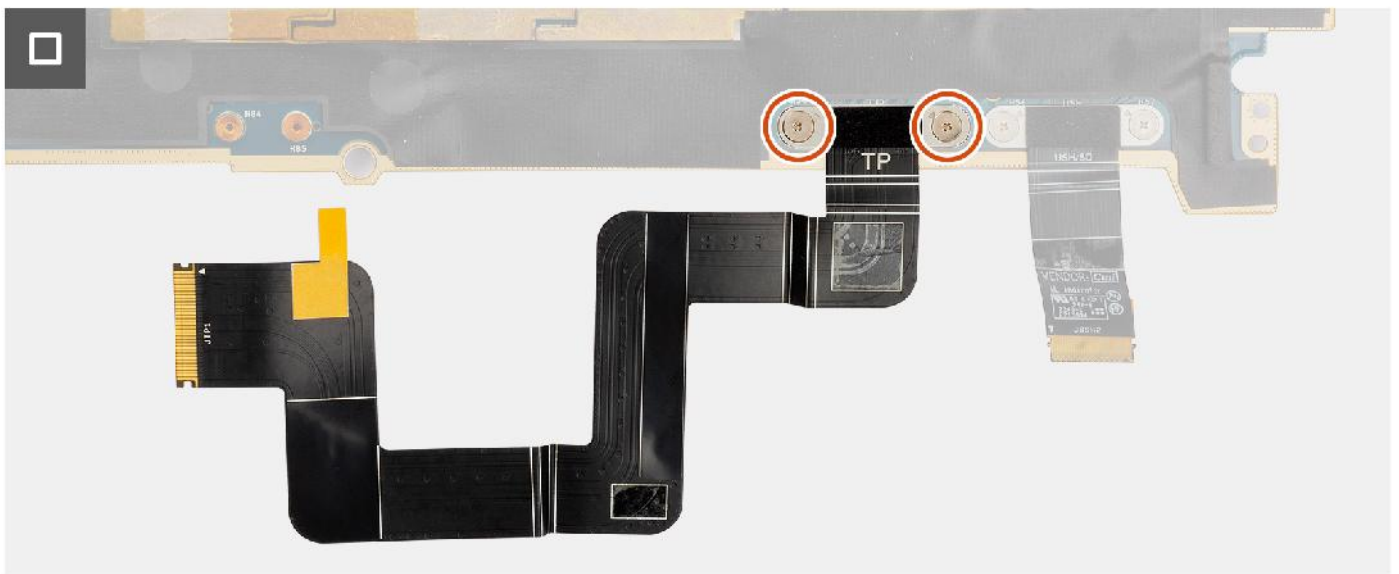
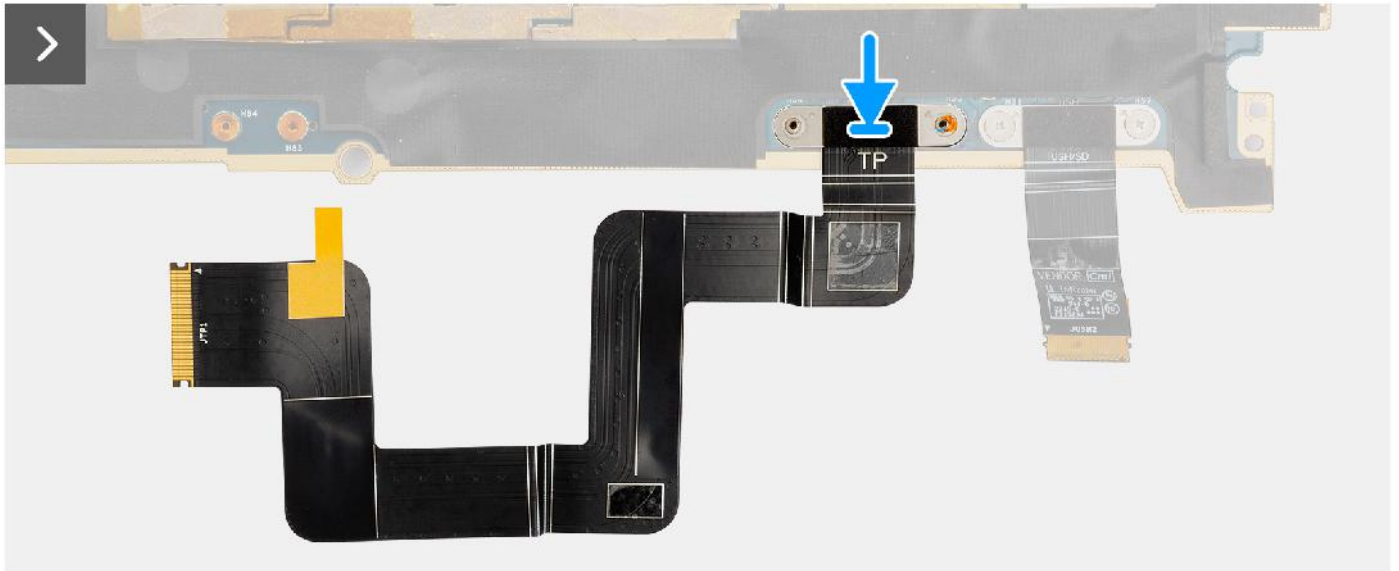
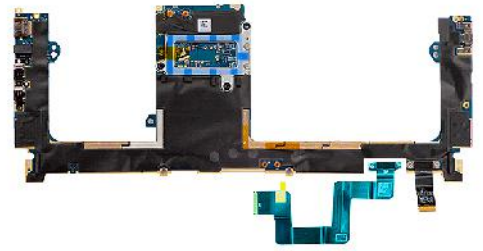

Steps

1. Align and place the touchpad FPC into its slot on the system board.
2. Replace the two (M1.4x1.2) screws that secure the touchpad FPC to the system board.
3. Connect the touchpad FPC to the connector on the system board.

Next steps

1. Install the [system board](#).
2. Install the [heatsink](#).

3. Install the [right fan](#).
4. Install the [left fan](#).
5. Install the [Battery](#).
6. Install the [VPU card](#), for systems shipped with a VPU card.
7. Install the [M.2 solid-state drive](#), for systems shipped with a solid-state drive.
8. Install the [base cover](#).
9. Install the [SD card](#).
10. Follow the procedure in [After working inside your computer](#).

SD card reader daughterboard FPC

Removing the SD card reader daughterboard FPC

Prerequisites

1. Follow the procedure in [Before working inside your computer](#).



NOTE: Ensure that your computer is in Service Mode. For more information see, step 6 in [Before working inside your computer](#).

2. Remove the [SD card](#).
3. Remove the [base cover](#).
4. Remove the [M.2 solid-state drive](#), for systems shipped with a solid-state drive.
5. Remove the [VPU card](#), for systems shipped with a VPU card.
6. Remove the [Battery](#).
7. Remove the [left fan](#).
8. Remove the [right fan](#).
9. Remove the [heatsink](#).
10. Remove the [system board](#).

About this task



CAUTION: The information in this removal section is intended for authorized service technicians only.

The following images indicate the location of the SD card reader daughterboard FPC and provide a visual representation of the removal procedure.



2x
M1.4x1.2

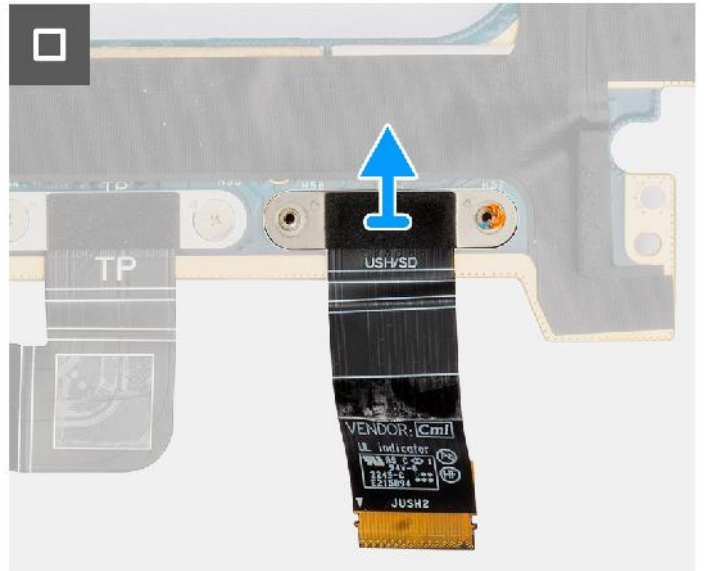
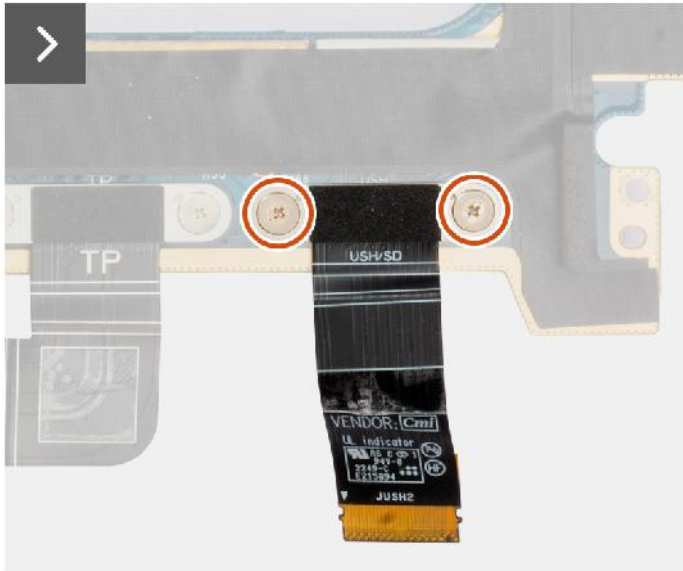

Steps

1. Remove the two (M1.4X1.2) screws that secure the SD card reader daughterboard FPC in place.
2. Disconnect and remove the SD card reader daughterboard FFC cable from the connector on the system board.

Installing the SD card reader daughterboard FPC

Prerequisites

If you are replacing a component, remove the existing component before performing the installation procedure.

About this task

CAUTION: The information in this installation section is intended for authorized service technicians only.

The following image indicates the location of the SD card reader daughterboard FPC and provides a visual representation of the installation procedure.



2x
M1.4x1.2

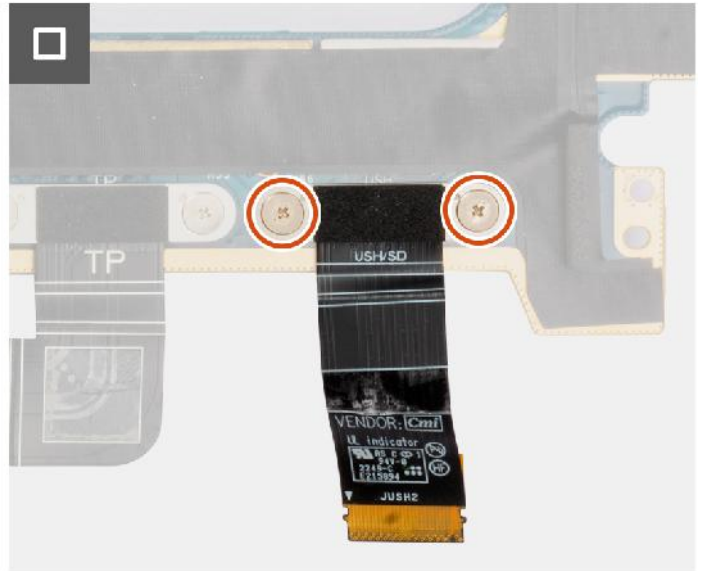
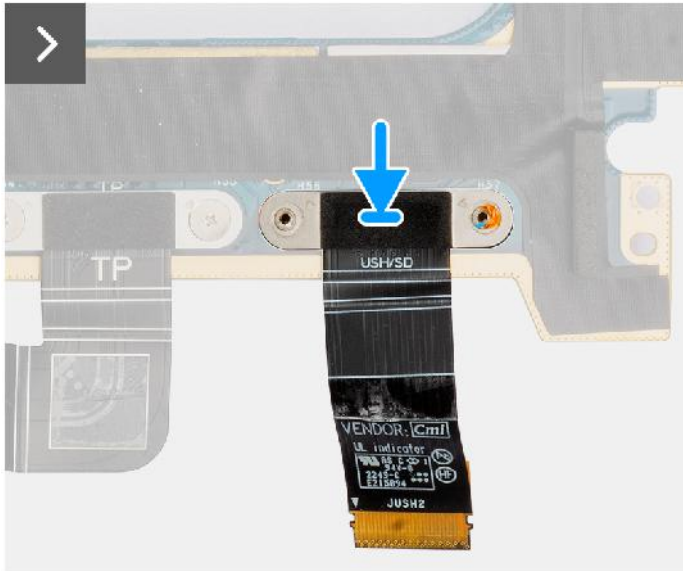
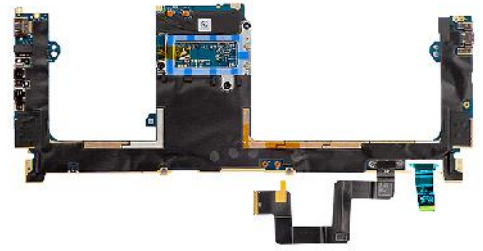

Steps

1. Align and place the SD card reader daughterboard FPC in place.
2. Replace the two (M1.4x1.2) screws to secure the SD card reader daughterboard FPC in place.
3. Connect the SD card reader daughterboard FFC cable to the connector on the system board.

Next steps

1. Install the [system board](#).
2. Install the [heatsink](#).
3. Install the [right fan](#).
4. Install the [left fan](#).
5. Install the [Battery](#).
6. Install the [VPU card](#), for systems shipped with a VPU card.
7. Install the [M.2 solid-state drive](#), for systems shipped with a solid-state drive.
8. Install the [base cover](#).
9. Install the [SD card](#).
10. Follow the procedure in [After working inside your computer](#).

USH and SD card reader daughterboard FPC

Removing the USH and SD card reader daughterboard FPC

Prerequisites

1. Follow the procedure in [Before working inside your computer](#).

NOTE: Ensure that your computer is in Service Mode. For more information see, step 6 in [Before working inside your computer](#).

2. Remove the [SD card](#).
3. Remove the [base cover](#).
4. Remove the [M.2 solid-state drive](#), for systems shipped with a solid-state drive.
5. Remove the [VPU card](#), for systems shipped with a VPU card.
6. Remove the [Battery](#).
7. Remove the [left fan](#).
8. Remove the [right fan](#).
9. Remove the [heatsink](#).
10. Remove the [system board](#).

About this task

CAUTION: The information in this removal section is intended for authorized service technicians only.

NOTE: The following procedure is applicable for systems shipped with a USH and SD card reader daughterboard FPC only.

The following images indicate the location of the USH and SD card reader daughterboard FPC and provide a visual representation of the removal procedure.



2x
M1.4x1.2

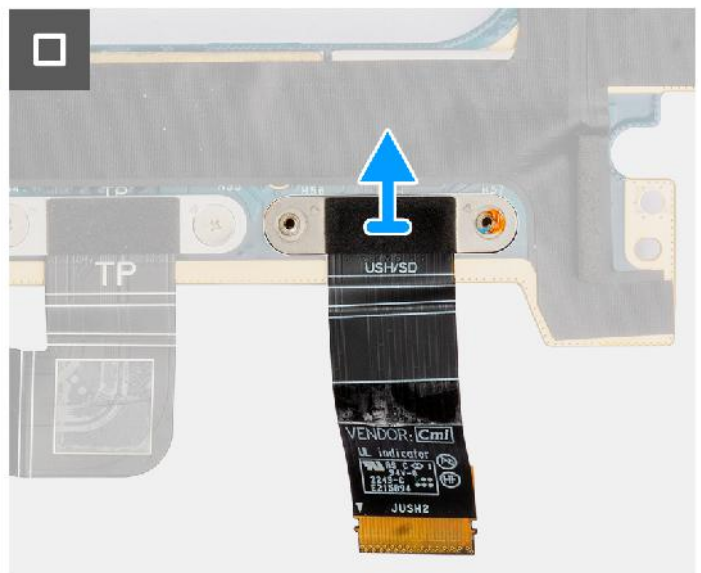
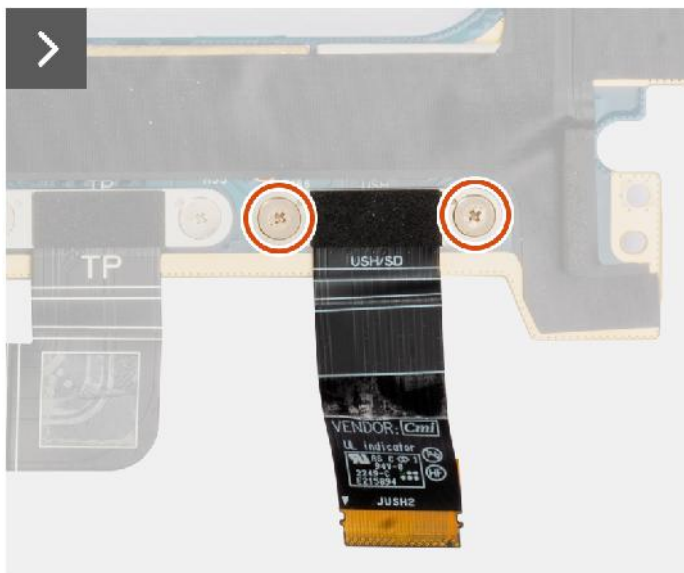

Steps

1. Remove the two (M1.4X1.2) screws that secure the USH and SD card reader daughterboard FPC in place.
2. Disconnect and remove the USH and SD card reader daughterboard FPC cable from the connector on the system board.

Installing the USH and SD card reader daughterboard FPC

Prerequisites

If you are replacing a component, remove the existing component before performing the installation procedure.

About this task

CAUTION: The information in this installation section is intended for authorized service technicians only.

The following image indicates the location of the USH and SD card reader daughterboard FPC and provides a visual representation of the installation procedure.

NOTE: The following procedure is applicable for systems shipped with a USH and SD card reader daughterboard FPC only.



2x
M1.4x1.2

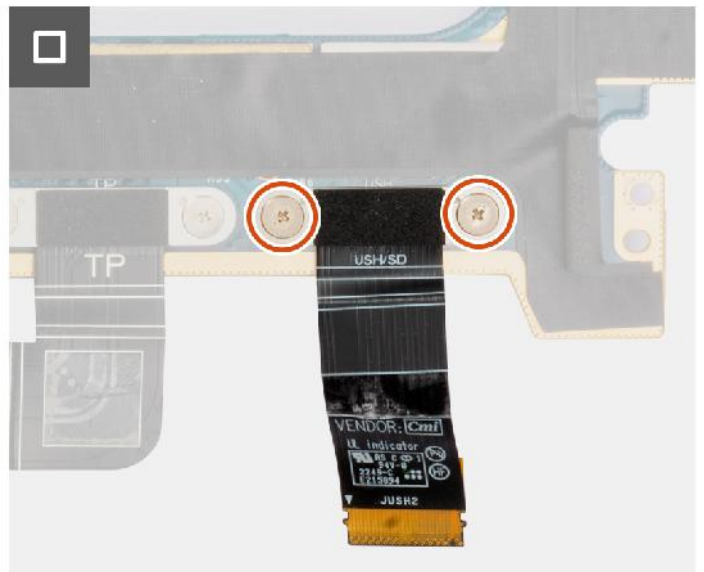
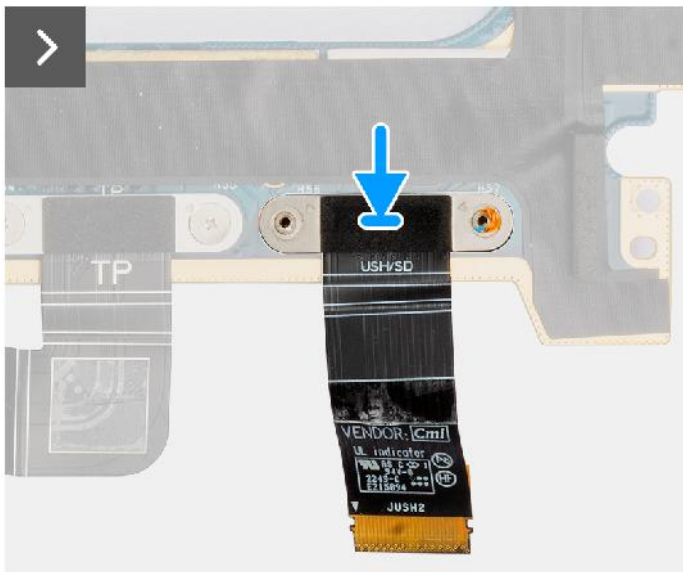

Steps

1. Align and place the USH and SD card reader daughterboard FPC in place.
2. Replace the two (M1.4x1.2) screws to secure the USH and SD card reader daughterboard FPC in place.
3. Connect the USH and SD card reader daughterboard FPC cable to the connector on the system board.

Next steps

1. Install the [system board](#).
2. Install the [heatsink](#).
3. Install the [right fan](#).
4. Install the [left fan](#).
5. Install the [Battery](#).
6. Install the [VPU card](#), for systems shipped with a VPU card.

7. Install the [M.2 solid-state drive](#), for systems shipped with a solid-state drive.
8. Install the [base cover](#).
9. Install the [SD card](#).
10. Follow the procedure in [After working inside your computer](#).

Wireless Local Area Network (WLAN) Antennas

Removing the WLAN antenna module

Prerequisites

1. Follow the procedure in [Before working inside your computer](#).

 **NOTE:** Ensure that your computer is in Service Mode. For more information see, step 6 in [Before working inside your computer](#).

2. Remove the [SD card](#).
3. Remove the [base cover](#).
4. Remove the [M.2 solid-state drive](#), for systems shipped with a solid-state drive.
5. Remove the [VPU card](#), for systems shipped with a VPU card.
6. Remove the [Battery](#).
7. Remove the [left fan](#).
8. Remove the [right fan](#).
9. Remove the [heatsink](#).
10. Remove the [system board](#).

About this task

 **CAUTION:** The information in this removal section is intended for authorized service technicians only.

 **NOTE:** The following procedure is applicable for systems shipped with WLAN antennas only.

The following images indicate the location of the WLAN antenna module and provide a visual representation of the removal procedure.



4x

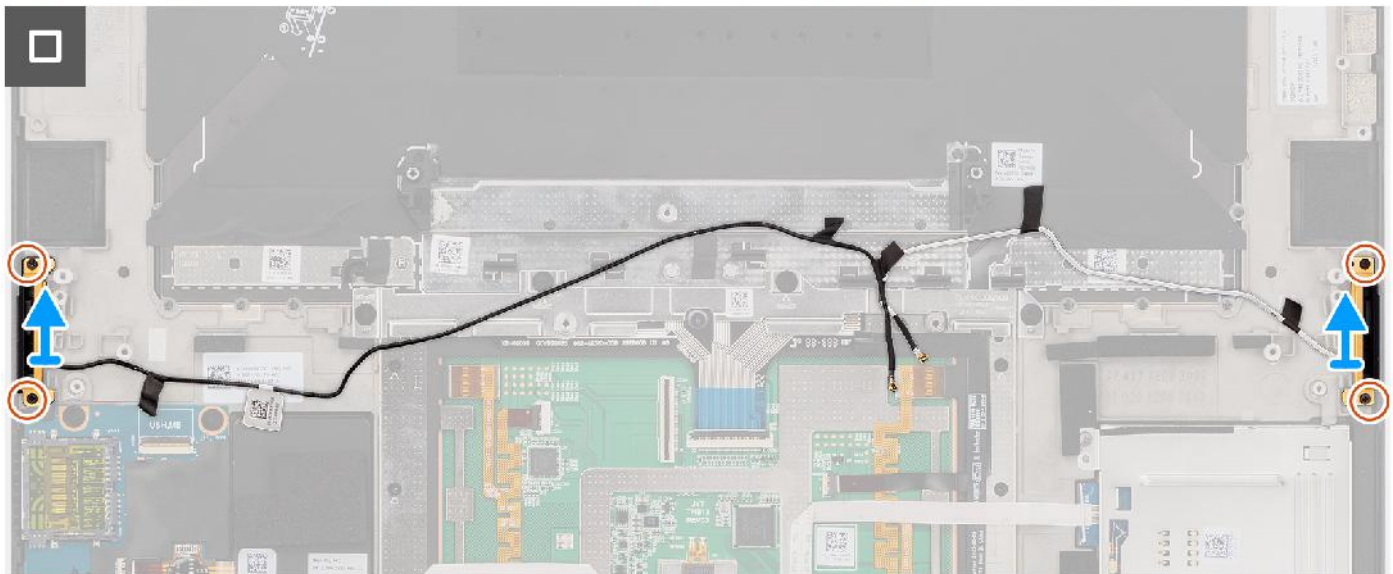
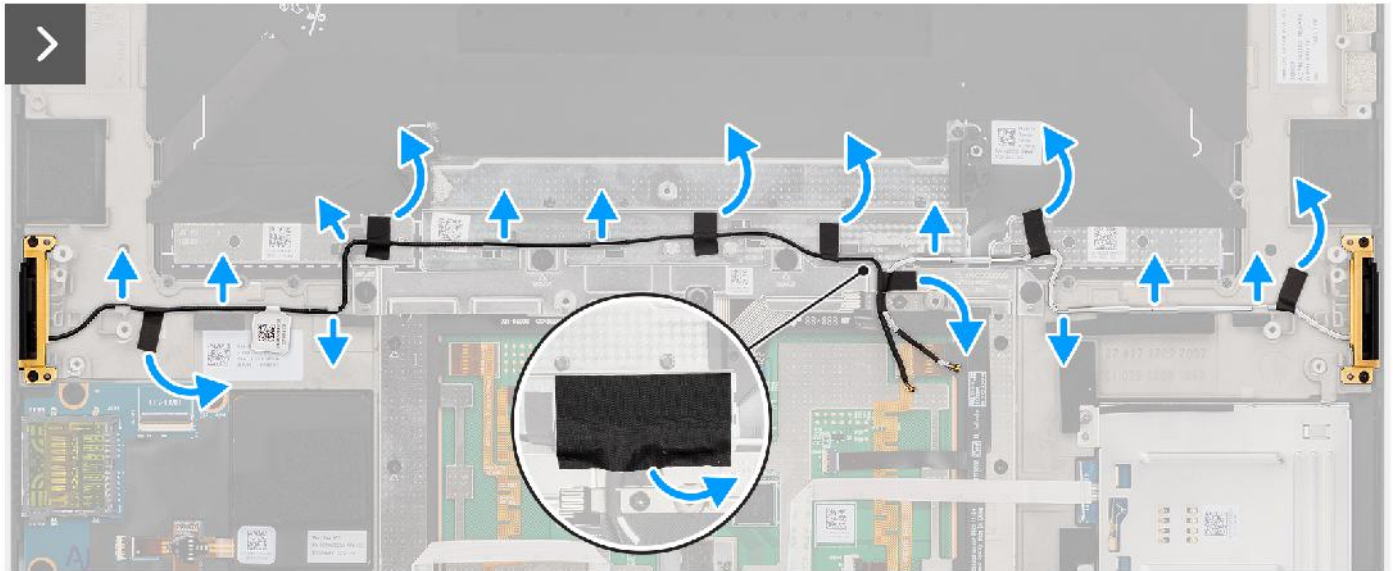
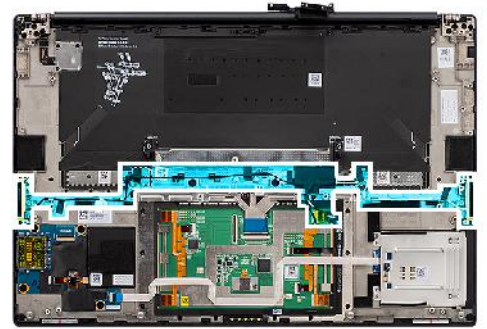

Steps

1. Remove the left and right tweeter speakers from their slots on the chassis.
2. Peel off the tape that secures the WLAN antenna cables to the palm-rest assembly.
3. Unroute the WLAN antenna cables from the routing guides on the palm-rest assembly.
4. Loosen the four captive screws that secure the WLAN antennas in place.
5. Remove the WLAN antennas off the system.

Installing the WLAN antenna module

Prerequisites

If you are replacing a component, remove the existing component before performing the installation procedure.

About this task

 **CAUTION:** The information in this installation section is intended for authorized service technicians only.

The following image indicates the location of the WLAN antenna module and provides a visual representation of the installation procedure.

 **NOTE:** The following procedure is applicable for systems shipped with WLAN antennas only.



4x

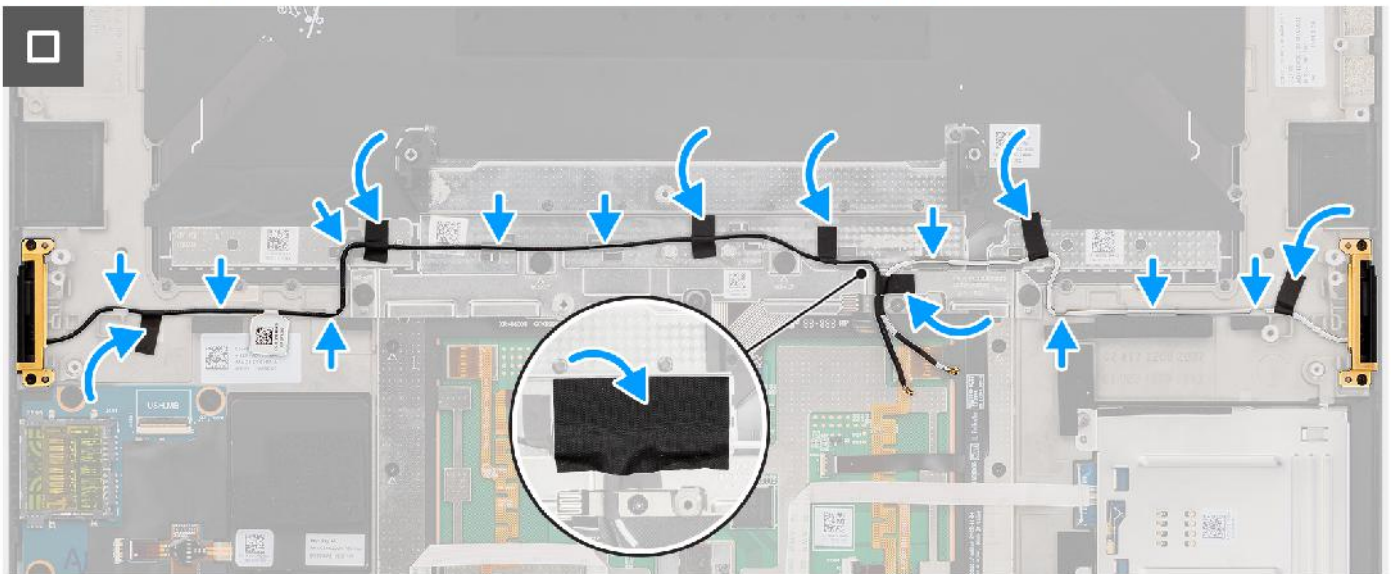
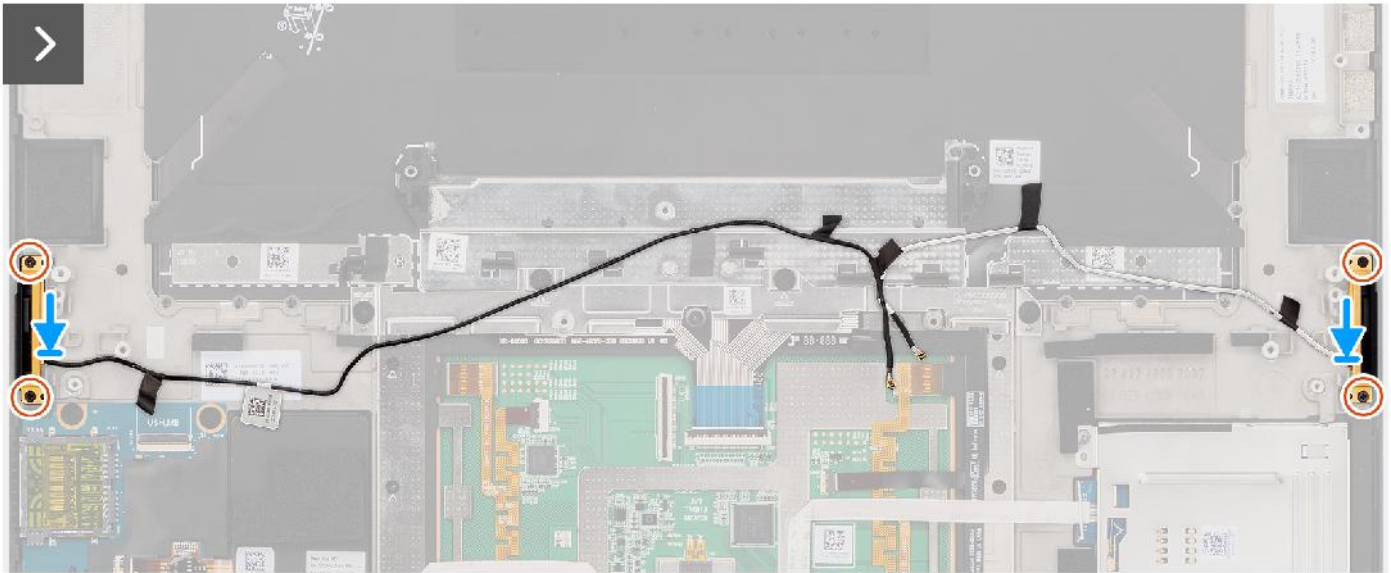
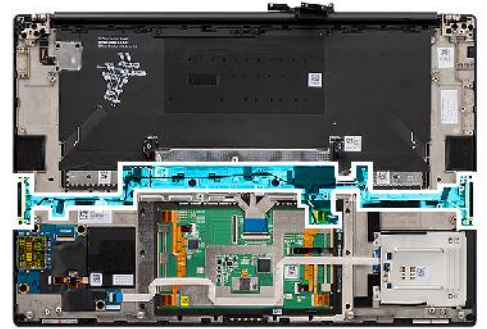

Steps

1. Align and place the WLAN antennas in the slot on the system.
2. Route the WLAN antenna cables through the routing guides on the palm-rest assembly.
3. Replace the four captive screws to secure the WLAN antenna cables to the palm-rest assembly.
4. Adhere the tape to secure the WLAN antenna cables to the palm-rest assembly.
5. Align and place the left and right speakers into the slot on the chassis.

Next steps

1. Install the [system board](#).
2. Install the [heatsink](#).
3. Install the [right fan](#).
4. Install the [left fan](#).
5. Install the [Battery](#).
6. Install the [VPU card](#), for systems shipped with a VPU card.
7. Install the [M.2 solid-state drive](#), for systems shipped with a solid-state drive.
8. Install the [base cover](#).
9. Install the [SD card](#).
10. Follow the procedure in [After working inside your computer](#).

Power button with fingerprint reader assembly

Removing the power button with fingerprint reader assembly

Prerequisites

1. Follow the procedure in [Before working inside your computer](#).
 **NOTE:** Ensure that your computer is in Service Mode. For more information see, step 6 in [Before working inside your computer](#).
2. Remove the [SD card](#).
3. Remove the [base cover](#).
4. Remove the [M.2 solid-state drive](#), for systems shipped with a solid-state drive.
5. Remove the [VPU card](#), for systems shipped with a VPU card.
6. Remove the [Battery](#).
7. Remove the [left fan](#).
8. Remove the [right fan](#).
9. Remove the [heatsink](#).
10. Remove the [system board](#).

About this task

 **CAUTION:** The information in this removal section is intended for authorized service technicians only.

The following images indicate the location of the power button with fingerprint reader and provide a visual representation of the removal procedure.



3x
M1.6x2

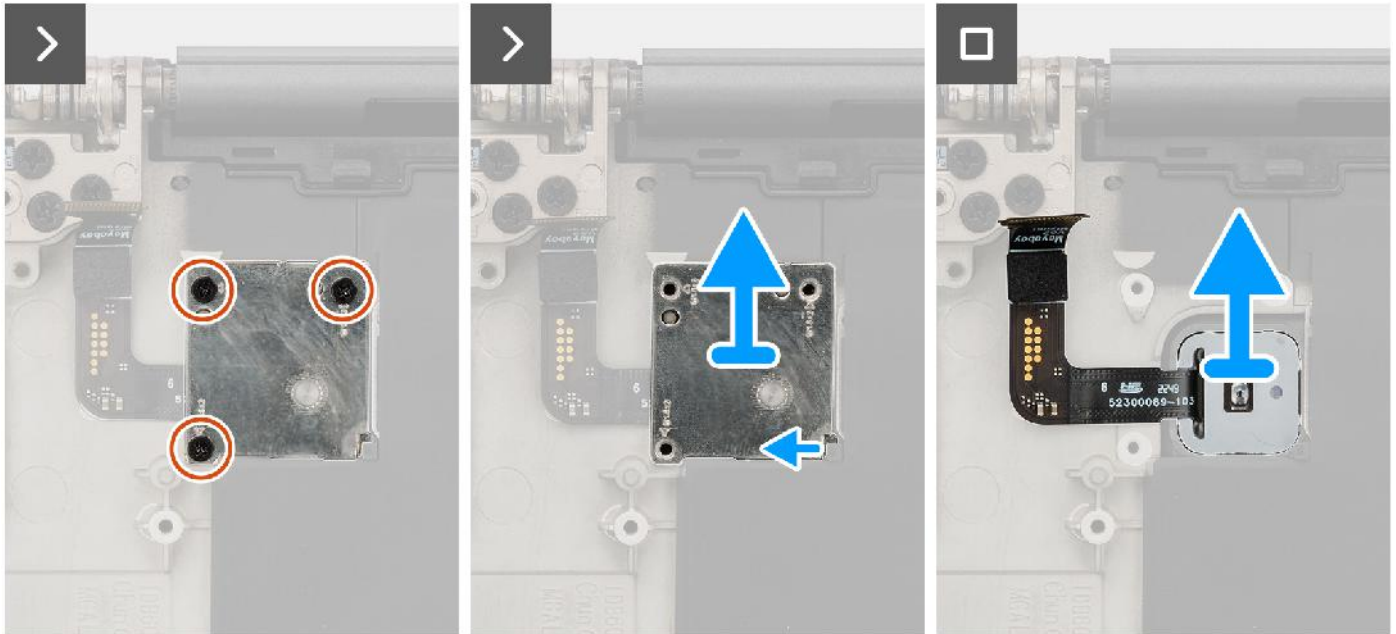
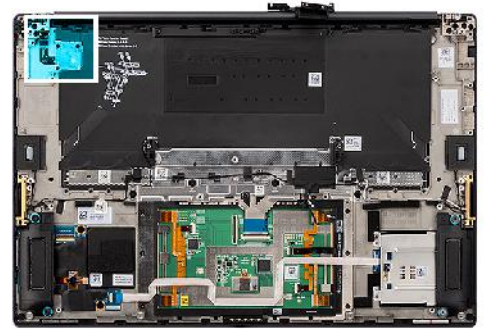

Steps

1. Remove the three (M1.6x2) screws that secure the power button with fingerprint reader bracket in place.
2. Lift the power button with fingerprint reader bracket off the system.
3. Peel off and remove the power button with fingerprint reader assembly from the palm-rest assembly.

Installing the power button with fingerprint reader assembly

Prerequisites

If you are replacing a component, remove the existing component before performing the installation procedure.

About this task

CAUTION: The information in this installation section is intended for authorized service technicians only.

The following images indicate the location of the power button with fingerprint reader and provides a visual representation of the installation procedure.



3x
M1.6x2

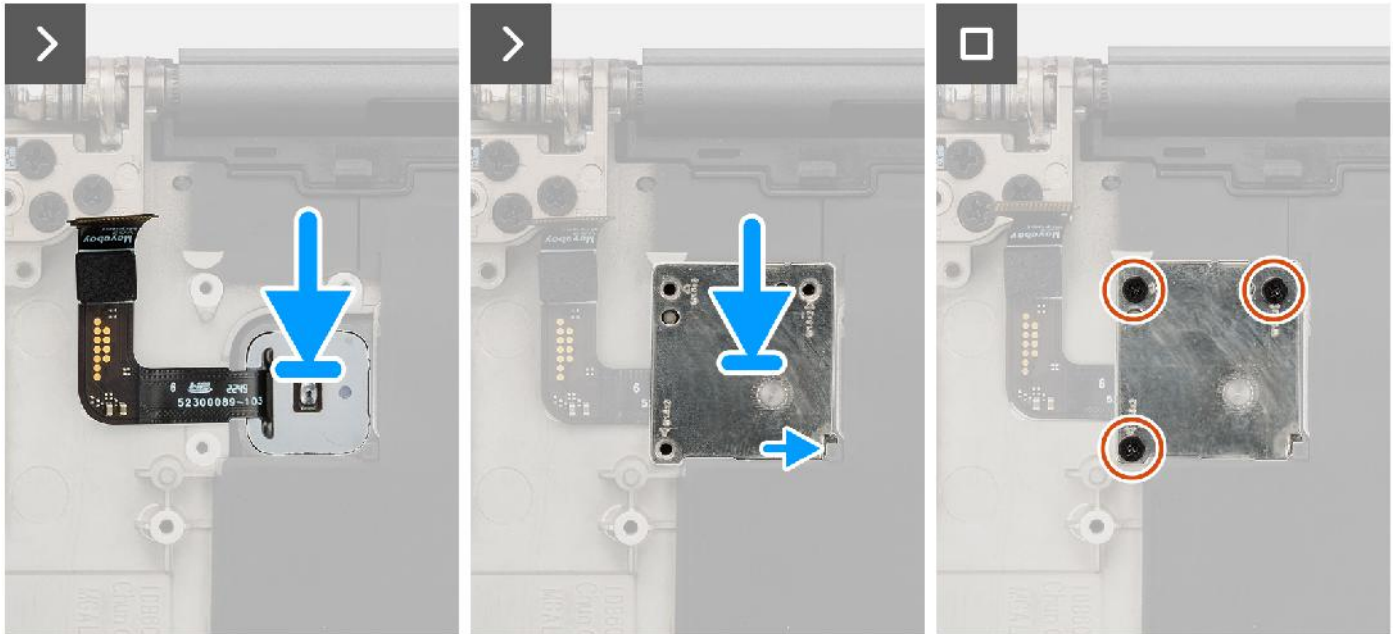
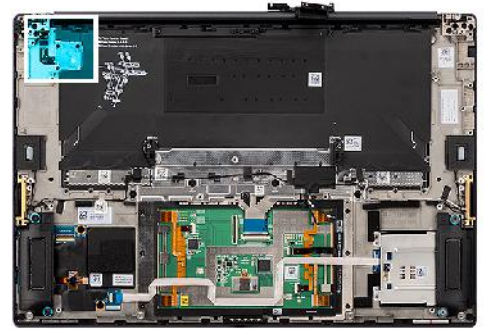

Steps

1. Align, place, and adhere the power button with fingerprint reader assembly on the palm-rest assembly.
2. Place the power button with fingerprint reader bracket on the power button assembly.
3. Replace the three (M1.6x2) screws to secure the power button bracket in place.

Next steps

1. Install the [system board](#).
2. Install the [heatsink](#).
3. Install the [right fan](#).
4. Install the [left fan](#).
5. Install the [Battery](#).
6. Install the [VPU card](#), for systems shipped with a VPU card.
7. Install the [M.2 solid-state drive](#), for systems shipped with a solid-state drive.
8. Install the [base cover](#).
9. Install the [SD card](#).
10. Follow the procedure in [After working inside your computer](#).

Palm-rest assembly

Removing the palm-rest assembly

Prerequisites

1. Follow the procedure in [Before working inside your computer](#).
 **NOTE:** Ensure that your computer is in Service Mode. For more information see, step 6 in [Before working inside your computer](#).
2. Remove the [SD card](#).
3. Remove the [base cover](#).
4. Remove the [M.2 solid-state drive](#), for systems shipped with a solid-state drive.
5. Remove the [VPU card](#), for systems shipped with a VPU card.
6. Remove the [Battery](#).
7. Remove the [display assembly](#).
8. Remove the [left fan](#).
9. Remove the [right fan](#).
10. Remove the [heatsink](#).
11. Remove the [smart-card reader](#) for systems shipped with a smart-card reader.
12. Remove the [GPU card](#) or [dummy GPU card](#).
13. Remove the [system board](#).
14. Remove the [speakers](#).
15. Remove the [WLAN antennas](#).
16. Remove the [power button with fingerprint reader assembly](#).

About this task

 **CAUTION:** The information in this removal section is intended for authorized service technicians only.

The following images indicate the location of the palm-rest assembly and provide a visual representation of the removal procedure.

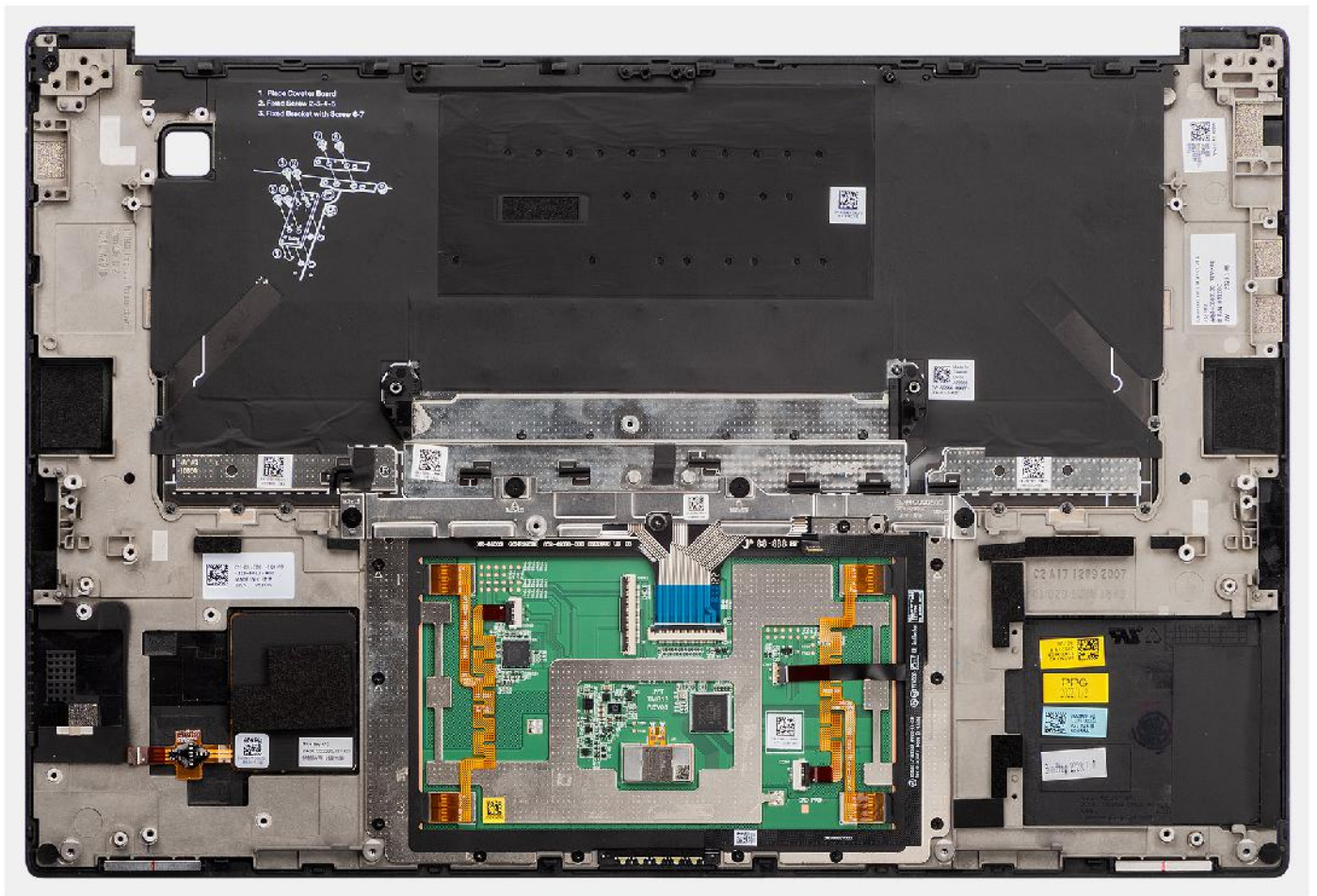

Installing the palm-rest assembly

Prerequisites

If you are replacing a component, remove the existing component before performing the installation procedure.

About this task

CAUTION: The information in this installation section is intended for authorized service technicians only.

The following images indicate the location of the palm-rest assembly and provide a visual representation of the removal procedure.

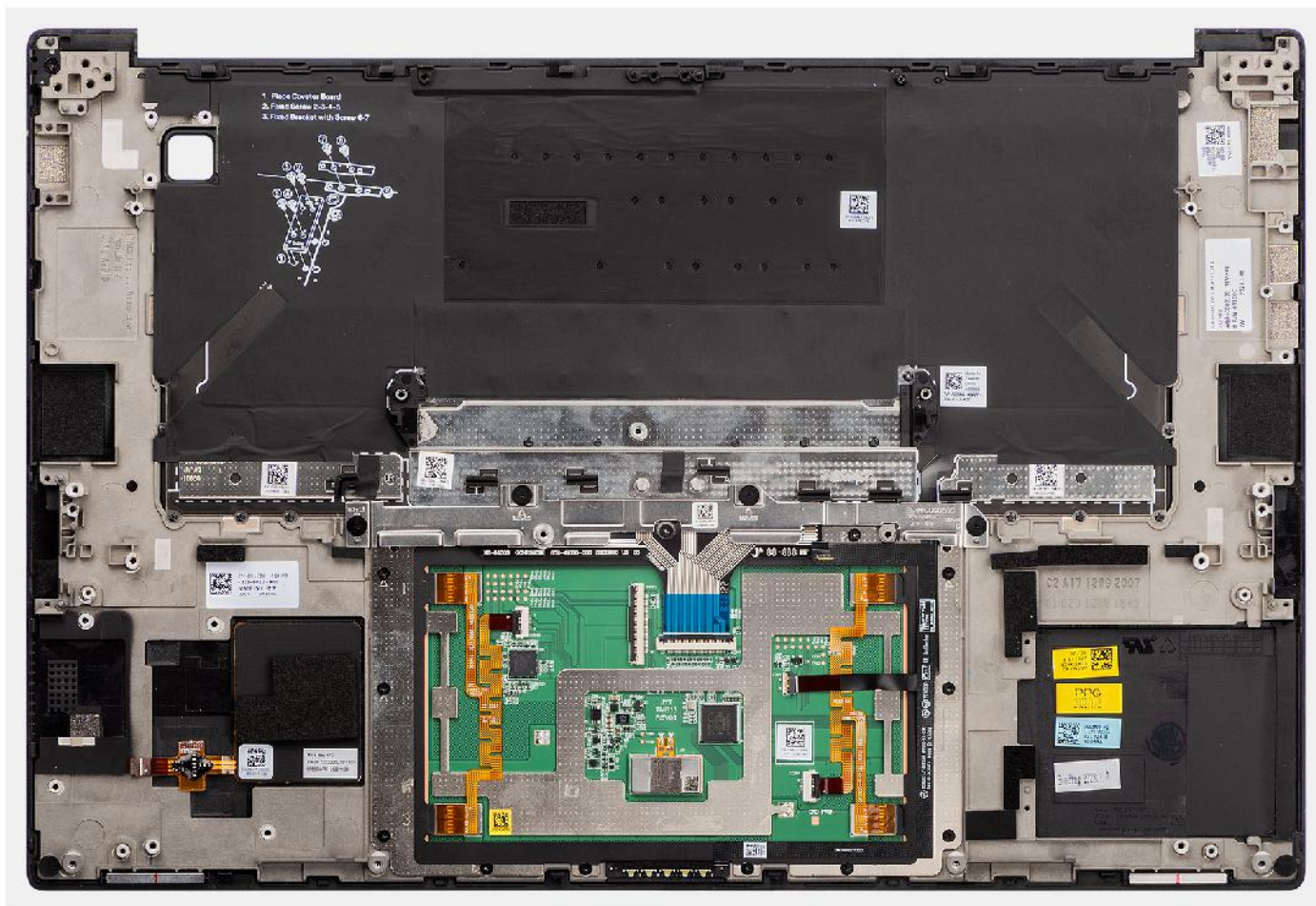

Steps

Place the palm-rest assembly on a flat surface.

Next steps

1. Install the [power button with fingerprint reader](#).
2. Install the [WLAN antennas](#).
3. Install the [speakers](#).
4. Install the [system board](#).
5. Install the [GPU card](#) or [dummy GPU card](#).
6. Install the [smart-card reader](#) for systems shipped with a smart-card reader.
7. Install the [heatsink](#).
8. Install the [right fan](#).
9. Install the [left fan](#).
10. Install the [display assembly](#).
11. Install the [Battery](#).
12. Install the [VPU card](#), for systems shipped with a VPU card.
13. Install the [M.2 solid-state drive](#), for systems shipped with a solid-state drive.
14. Install the [base cover](#).
15. Install the [SD card](#).
16. Follow the procedure in [After working inside your computer](#).

Software

This chapter details the supported operating systems along with instructions on how to install the drivers.

Operating system

Your Dell Precision 5680 supports the following operating systems:

- Windows 11 Home, 64-bit
- Windows 11 Pro, 64-bit
- Windows 11 Pro for Workstation, 64-bit
- Windows 11 Pro for Education, 64-bit
- Windows 11 Enterprise, 64-bit
- Ubuntu 22.04 LTS, 64-bit

Drivers and downloads

When troubleshooting, downloading or installing drivers it is recommended that you read the Dell Knowledge Base article, Drivers and Downloads FAQ [000123347](#).

BIOS setup

CAUTION: Unless you are an expert computer user, do not change the settings in the BIOS Setup program. Certain changes can make your computer work incorrectly.

NOTE: Depending on the computer and its installed devices, the items listed in this section may or may not be displayed.

NOTE: Before you change BIOS Setup program, it is recommended that you write down the BIOS Setup program screen information for future reference.

Use the BIOS Setup program for the following purposes:

- Get information about the hardware installed in your computer, such as the amount of RAM and the size of the hard drive.
- Change the system configuration information.
- Set or change a user-selectable option, such as the user password, type of hard drive installed, and enabling or disabling base devices.

Entering BIOS setup program

About this task

Turn on (or restart) your computer and press F2 immediately.

Navigation keys

NOTE: For most of the System Setup options, changes that you make are recorded but do not take effect until you restart the system.

Table 31. Navigation keys

Keys	Navigation
Up arrow	Moves to the previous field.
Down arrow	Moves to the next field.
Enter	Selects a value in the selected field (if applicable) or follow the link in the field.
Spacebar	Expands or collapses a drop-down list, if applicable.
Tab	Moves to the next focus area. NOTE: For the standard graphics browser only.
Esc	Moves to the previous page until you view the main screen. Pressing Esc in the main screen displays a message that prompts you to save any unsaved changes and restarts the system.

One time boot menu

To enter **one time boot menu**, turn on your computer, and then press F12 immediately.

NOTE: It is recommended to shutdown the computer if it is on.

The one-time boot menu displays the devices that you can boot from including the diagnostic option. The boot menu options are:

- Removable Drive (if available)
- STXXXX Drive (if available)
- **i** **NOTE:** XXX denotes the SATA drive number.
- Optical Drive (if available)
- SATA Hard Drive (if available)
- Diagnostics
- **i** **NOTE:** Choosing **Diagnostics**, will display the **ePSA diagnostics** screen.

The boot sequence screen also displays the option to access the System Setup screen.

System setup options

i **NOTE:** Depending on this computer and its installed devices, the items that are listed in this section may or may not be displayed.

Table 32. System setup options—System information menu

Overview for Dell Precision 5680	
BIOS Version	Displays the BIOS version number.
Service Tag	Displays the Service Tag of the computer.
Asset Tag	Displays the Asset Tag of the computer.
Manufacture Date	Displays the manufacture date of the computer.
Ownership Date	Displays the ownership date of the computer.
Express Service Code	Displays the express service code of the computer.
Ownership Tag	Displays the ownership tag of the computer.
Signed Firmware Update	Displays whether the signed firmware update is enabled. Default: Enabled
Battery	Displays the battery health information.
Primary	Displays the primary battery.
Battery Level	Displays the battery level.
Battery State	Displays the battery state.
Health	Displays the battery health.
AC Adapter	Displays whether an AC adapter is connected. If connected, the AC adapter type.
Battery Life Type	Displays the battery life type.
PROCESSOR	
Processor Type	Displays the processor type.
Maximum Clock Speed	Displays the maximum processor clock speed.
Minimum Clock Speed	Displays the minimum processor clock speed.
Current Clock Speed	Displays the current processor clock speed.
Core Count	Displays the number of cores on the processor.
Processor ID	Displays the processor identification code.
Processor L2 Cache	Displays the processor L2 Cache size.
Processor L3 Cache	Displays the processor L3 Cache size.

Table 32. System setup options—System information menu (continued)

Overview for Dell Precision 5680	
Microcode Version	Displays the microcode version.
Intel Hyper-Threading Capable	Displays whether the processor is Hyper-Threading (HT) capable.
64-Bit Technology	Displays whether 64-bit technology is used.
MEMORY	
Memory Installed	Displays the total computer memory installed.
Memory Available	Displays the total computer memory available.
Memory Speed	Displays the memory speed.
Memory Channel Mode	Displays single or dual channel mode.
Memory Technology	Displays the technology that is used for the memory.
DEVICES	
Panel Type	Displays the Panel Type of the computer.
Video Controller	Displays the integrate graphics information of the computer.
Video Memory	Displays the video memory information of the computer.
Wi-Fi Device	Displays the Wi-Fi device installed in the computer.
Native Resolution	Displays the native resolution of the computer.
Video BIOS Version	Displays the video BIOS version of the computer.
Audio Controller	Displays the audio controller information of the computer.
Bluetooth Device	Displays whether a Bluetooth device is installed in the computer.
Pass Through MAC Address	Displays the MAC address of the video pass-through.
dGPU Video Controller	Displays the dGPU video controller.

Table 33. System setup options—Boot Configuration menu

Boot Configuration	
Boot Sequence	
Boot Mode: UEFI only	Displays the boot mode of this computer.
Boot Sequence	Displays the boot sequence.
Secure Digital (SD) Card Boot	
	Enables or disables Secure Digital (SD) Card boot.
Secure Boot	
Enable Secure Boot	Enables or disables checking of boot software (including firmware drivers and the operating system).
Enable Microsoft UEFI CA	By default, the is enabled.
Secure Boot Mode	Modifies the behavior of Secure Boot to allow evaluation or enforcement of UEFI driver signatures. By default, Deployed Mode is selected.
Expert Key Management	
Enable Custom Mode	Enables or disables custom mode to allow keys in the PK, KEK, db, and dbx security key databases to be modified. Default: OFF

Table 34. System setup options—Integrated Devices menu

Integrated Devices	
Date/Time	
Date	Sets the computer date in MM/DD/YYYY format. Changes to the date take effect immediately.
Time	Sets the computer time in HH/MM/SS 24-hour format. You can switch between 12-hour and 24-hour clock. Changes to the time take effect immediately.
Thunderbolt Adapter Configuration	
Enable Thunderbolt Technology Support	Enables or disables the Thunderbolt Technology feature and associated ports and adapters. Default: ON
Enable Thunderbolt Boot Support	Enables or disables Thunderbolt adapter features during pre-boot. Default: OFF
Enable Thunderbolt (and PCIe behind TBT) pre-boot modules	Enables or disables the setting that allows PCIe devices that are connected via a Thunderbolt adapter. Default: OFF
Disable USB4 PCIE Tunneling	Disable the USB4 PCIE Tunneling option. By default, the option is disabled.
Video/Power only on Type-C Ports	Enable or disable the Type-C port functionality to video or only power. By default, the Video/Power only on Type-C Ports option is disabled.
Camera	
Enable Camera	Enables or disables the camera. By default, Enable Camera is selected.
Audio	
Enable Audio	Enables or disables all integrated audio controller. Default: ON
Enable Microphone	Enables or disables microphone. By default, Enable Microphone is selected.
Enable Internal Speaker	Enables or disables internal speaker. By default, Enable Internal Speaker is selected.
USB Configuration	
	Enables or disables booting from USB mass storage devices such as external hard drive, optical drive, and USB drive. By default, Enable USB Boot Support is selected. By default, Enable External USB Ports is selected.
Type-C Dock Override	
	Enables to use connected Type-C Dell Dock to provide data stream with external USB ports disabled. When Type-C Dock override is enabled, the Video/Audio/Lan submenu is activated. By default, the Type-C Dock Override option is enabled.
Miscellaneous Devices	
Enable Fingerprint Reader Device	Enables or disables the Fingerprint Reader Device. By default, Enable Fingerprint Reader Device is selected.

Table 35. System setup options—Storage menu

Storage	
SATA Operation	Configures operating mode of the integrated SATA hard drive controller. Default: RAID On. SATA is configured to support RAID (Intel Rapid Restore Technology).
Storage Interface	Displays the storage interface.
Drive Information	Displays the information of various onboard drives.
Enable SMART Reporting	Enables or disables Self-Monitoring, Analysis, and Reporting Technology (SMART). Default: OFF
Enable MediaCard	Enables to switch all media cards On/Off or set the media card to read-only state. By default, Enable Secure Digital (SD) Card is selected.
Secure Digital (SD) Card Read-Only Mode	Enable or disable the SD card read-only mode. By default, the Secure Digital (SD) Card Read-Only Mode option is not enabled.

Table 36. System setup options—Display menu

Display	
Display Brightness	
Brightness on battery power	Sets the screen brightness when the computer is running on battery power. Default: 50
Brightness on AC power	Sets the screen brightness when the computer is running on AC power. Default: 100
Touch Screen	Enables or disables the touch screen for the OS. NOTE: The touch screen will always work in the BIOS setup irrespective of this setting.
Full Screen Logo	Enabled or disabled the computer to display full screen logo if the image match screen resolution. Default: OFF

Table 37. System setup options—Connection menu

Connection	
Wireless Device Enable	Enable or disable internal WLAN/Bluetooth devices. By default, WLAN is selected. By default, Bluetooth is selected.
Enable UEFI Network Stack	
Enable UEFI Network Stack	When enabled, UEFI networking protocols are installed and available, allowing pre-OS and early OS networking features to use any enabled NICs. This may be used without PXE turned on. Default: ON
Wireless Radio Control	
Control WLAN radio	Enables to sense the connection of the computer to a wired network and subsequently disable the selected wireless radios (WLAN and/or WWAN).

Table 37. System setup options—Connection menu (continued)

Connection	
	Upon disconnection from the wired network, the selected wireless radios are re-enabled. Default: OFF
Dynamic Wireless Transmit Power	By default, the option is enabled.
HTTPs Boot Feature	
HTTPs Boot	Enable or disable the HTTPs Boot feature. By default, the HTTPs Boot option is enabled.
HTTPs Boot Mode	With Auto Mode, the HTTPs Boot extracts Boot URL from the DHCP. With Manual Mode, the HTTPs Boot reads Boot URL from the user-provided data. By default, the Auto Mode option is enabled.

Table 38. System setup options—Power menu

Power	
Battery Configuration	Enables the computer to run on battery during power usage hours. Use the below options to prevent AC power usage between certain times of each day. By default Adaptive is selected.
Advanced Configuration	
Enable Advanced Battery Charge Configuration	Enables Advanced Battery Charge Configuration from the beginning of the day to a specified work period. Advanced Battery Charged maximizes battery health while still supporting heavy use during the work day. Default: OFF
Peak Shift	Enables the computer to run on battery during peak power usage hours. Default: OFF
Thermal Management	Sets cooling fan and processor heat management to adjust system performance, noise, and temperature. By default, Optimized is selected.
USB Wake Support	
Wake on Dell USB-C Dock	Enables connecting a Dell USB-C Dock to wake the computer from Standby, Hibernate, or Power off. Default: ON
Block Sleep	Blocks the computer from entering Sleep (S3) mode in the operating system. Default: OFF
	NOTE: If enabled, the computer will not go to sleep, Intel Rapid Start will be disabled automatically, and the operating system power option will be blank if it was set to Sleep.
Lid Switch	
Enable Lid Switch	Enables or disables the lid switch. Default: ON
Power On Lid Open	Enables the computer to power up from the off state whenever the lid is opened. Default: ON

Table 38. System setup options—Power menu (continued)

Power	
Intel Speed Shift Technology	<p>Enables or disables the Intel Speed Shift Technology support. Setting this option to enable allows the operating system to select the appropriate processor performance automatically.</p> <p>Default: ON</p>

Table 39. System setup options—Security menu

Security	
TPM 2.0 Security On	<p>Select whether or not the Trusted Platform Model (TPM) is visible to the OS.</p> <p>Default: ON</p>
PPI Bypass for Clear Commands	<p>Enables or disables the operating system to skip BIOS Physical Presence Interface (PPI) user prompts when issuing the Clear command.</p> <p>Default: OFF</p>
Attestation Enable	<p>Enables to control whether the TPM Endorsement Hierarchy is available to the OS. Disabling this setting restricts the ability to use the TPM for signature operations.</p> <p>Default: ON</p>
Key Storage Enable	<p>Enables to control whether the TPM Endorsement Hierarchy is available to the OS. Disabling this setting restricts the ability to use the TPM for storing owner data.</p> <p>Default: ON</p>
SHA-256	<p>Enables or disables the BIOS and the TPM to use the SHA-256 hash algorithm to extend measurements into the TPM PCRs during BIOS boot.</p> <p>Default: ON</p>
Clear	<p>Enables or disables the computer to clear the TPM owner information, and returns the TPM to the default state.</p> <p>Default: OFF</p>
Chassis Intrusion	<p>Controls the chassis intrusion feature.</p> <p>By default, the option is disabled.</p>
SMM Security Mitigation	
SMM Security Mitigation	<p>Enables or disables additional UEFI SMM Security Mitigation protections.</p> <p>Default: ON</p> <p>i NOTE: This feature may cause compatibility issues or loss of functionality with some legacy tools and applications.</p>
Data Wipe on Next Boot	
Start Data Wipe	<p>When enabled, the BIOS will queue up a data wipe cycle for storage device(s) connected to the motherboard on the next reboot.</p> <p>Default: OFF</p>
Absolute	
Absolute	<p>Enables, disables or permanently disable the BIOS module interface of the optional Absolute Persistence Module service from Absolute Software.</p> <p>By default, Enable Absolute is selected.</p>
UEFI Boot Path Security	

Table 39. System setup options—Security menu (continued)

Security	
UEFI Boot Path Security	Controls whether the system will prompt the user to enter the admin password (if set) when booting to a UEFI boot path device from the F12 boot menu. By default, Always Except Internal HDD is selected.
Firmware Device Tamper Detection	By default, the Silent option is enabled.
Clear Firmware Tamper Detection	By default, the option is disabled.

Table 40. System setup options—Passwords menu

Passwords	
Admin Password	Sets, changes, or deletes the administrator password (sometimes called the "setup password"). The administrator password enables several security features.
System Password	Set, change, or delete the computer password.
M.2 PCIe SSD1	
Password Configuration	
Upper Case Letter	When enabled, password must contain at least one upper case letter. Default: OFF
Lower Case Letter	When enabled, password must contain at least one lower case letter. Default: OFF
Digit	When enabled, password must contain at least one digit number. Default: OFF
Special Character	When enabled, password must contain at least one special character. Default: OFF
Minimum Characters	Sets the minimum number of characters allowed for passwords. Default: 04
Password Bypass	
Password Bypass	When enabled, the system and the hard drive passwords are prompted when the computer is powered on from the Off state. By default, Disabled is selected.
Password Changes	
Enable Non-Admin Password Changes	When On, users can change the system and the hard drive password without the need for administrator password. Default: ON
Admin Setup Lockout	
Enable Admin Setup Lockout	Enables or disables the user from entering BIOS Setup when an administrator password is set. Default: OFF
Master Password Lockout	
Enable Master Password Lockout	Enables or disables the master password support. Default: OFF
Allow Non-Admin PSID Revert	

Table 40. System setup options—Passwords menu (continued)

Passwords	
Enable Allow Non-Admin PSID Revert	Controls access to the Physical Security ID (PSID) revert of NVMe hard-drives from the Dell Security Manager prompt. By default, the option is disabled.

Table 41. System setup options—Update Recovery menu

Update Recovery	
UEFI Capsule Firmware Updates	
Enable UEFI Capsule Firmware Updates	Controls whether this computer allows BIOS updates via UEFI capsule update packages. Default: ON
BIOS Recovery from Hard Drive	
BIOS Recovery from Hard Drive	Enables the computer to recover from a bad BIOS image, as long as the Boot Block portion is intact and functioning. Default: ON
	i NOTE: BIOS recovery is designed to fix the main BIOS block and cannot work if the Boot Block is damaged. In addition, this feature cannot work in the event of EC corruption, ME corruption, or a hardware issue. The recovery image must exist on an unencrypted partition on the drive.
BIOS Downgrade	
Allow BIOS Downgrade	Controls flashing of the system firmware to previous revisions. Default: ON
SupportAssist OS Recovery	
SupportAssist OS Recovery	Enables or disables the boot flow for SupportAssist OS Recovery tool in the event of certain system errors. Default: ON
BIOSConnect	
BIOSConnect	Enables or disables cloud Service OS recover if the main operating system fails to boot with the number of failures equal to or greater than the value specified by the Auto OS Recovery Threshold setup option. Default: ON
Dell Auto OS Recovery Threshold	
	Controls the automatic boot flow for SupportAssist System Resolution Console and for Dell operating system Recovery tool. By default, 2 is selected.

Table 42. System setup options—System Management menu

System Management	
Service Tag	Displays the Service Tag of the computer.
Asset Tag	Creates a system Asset Tag that can be used by an IT administrator to uniquely identify a particular system. Once set in BIOS, the Asset Tag cannot be changed.
AC Behavior	
Wake on AC	Enables the computer to turn on and go to boot when AC power is supplied to the computer. Default: OFF

Table 42. System setup options—System Management menu (continued)

System Management	
Wake on LAN/WLAN	
Wake on LAN/WLAN	Enables or disables the computer to turn on by a special LAN/WLAN signal. By default, Disabled is selected.
Auto on Time	Enable to set the computer to turn on automatically every day or on a preselected date and time. This option can be configured only if the Auto On Time is set to Everyday, Weekdays, or Selected Days. By default, the option is disabled.
Intel AMT Capability	By default, the Restrict Preboot Access option is selected.
Diagnostics	
OS Agent Requests	By default, the option is enabled.
Power-on-Self-Test Automatic Recovery	By default, the option is enabled.

Table 43. System setup options—Keyboard menu

Keyboard	
Fn Lock Options	
Fn Lock Options	Enables or disables the Fn lock option. Default: ON
Lock Mode	Default: Lock Mode Secondary. Lock Mode Secondary = If this option is selected, the F1-F12 keys scan the code for their secondary functions.
Keyboard Illumination	
Keyboard Illumination	Configures the operating mode of the keyboard illumination feature. Default: Dim
Keyboard Backlight Timeout on AC	
Keyboard Backlight Timeout on AC	Configures the timeout value for the keyboard when an AC adapter is connected to the computer. The keyboard backlight timeout value is only effect when the backlight is enabled. Default, 10 seconds
Keyboard Backlight Timeout on Battery	
Keyboard Backlight Timeout on Battery	Configures the timeout value for the keyboard when the computer is running on battery. The keyboard backlight timeout value is only effect when the backlight is enabled. Default, 10 seconds
Device Configuration Hotkey Access	Manages whether you can access device configuration screens through hotkeys during computer startup. By default, the option is enabled.

Table 44. System setup options—Pre-Boot Behavior menu

Pre-Boot Behavior	
Adapter Warnings	
Enable Adapter Warnings	Enables or disables the computer to display adapter warning messages when adapters with too little power capacity are detected.

Table 44. System setup options—Pre-Boot Behavior menu (continued)

Pre-Boot Behavior	
	Default: ON
Warnings and Errors	
Warnings and Errors	Selects an action on encountering a warning or error during boot. By default, Prompt on Warnings and Errors is selected.
	i NOTE: Errors deemed critical to the operation of the computer hardware will always halt the computer.
USB-C Warnings	
Enable Dock Warning Messages	Enables or disables dock warning messages. Default: ON
Fastboot	
Fastboot	Configures the speed of the UEFI boot process. By default, Thorough is selected.
Extend BIOS POST Time	
Extend BIOS POST Time	Configures the BIOS POST (Power-On Self-Test) load time. By default, 0 seconds is selected.
MAC Address Pass-Through	
MAC Address Pass-Through	Replaces the external NIC MAC address (in a supported dock or dongle) with the selected MAC address from the computer. By default, System Unique MAC Address is selected. By default, the Passthrough MAC Address option is enabled.
Sign of Life	
Early Logo Display	Displays Logo Sign of Life. Default: ON
Keyboard Backlight Sign of Life	By default, the option is enabled.

Table 45. System setup options—Virtualization menu

Virtualization	
Intel Virtualization Technology	
Intel Virtualization Technology	Enables or disables the computer to run a virtual machine monitor (VMM). Default: ON
VT for Direct I/O	
Enable Intel VT for Direct I/O	Enables or disables the computer to perform Virtualization Technology for Direct I/O (VT-d). VT-d is an Intel method that provides virtualization for memory map I/O. Default: ON
Intel Trusted Execution Technology(TXT)	
Enable Intel Trusted Execution Technology (TXT)	Specifies whether a measured Virtual Machine Monitor (MVMM) can utilize the additional hardware capabilities provided by Intel Trusted Execution Technology. By default, the option is disabled.

Table 45. System setup options—Virtualization menu (continued)

Virtualization	
DMA Protection	
Enable Pre-Boot DMA Support	By default, the option is enabled.
Enable OS Kernel DMA Support	By default, the option is enabled.

Table 46. System setup options—Performance menu

Performance	
Multi-Core Support	
Active Cores	Changes the number of CPU cores available to the operating system. The default value is set to the maximum number of cores. By default, All Cores is selected.
Intel SpeedStep	
Enable Intel SpeedStep Technology	Enables or disables the Intel SpeedStep Technology to dynamically adjust processor voltage and core frequency, decreasing average power consumption and heat production. Default: ON
C-States Control	
Enable C-State Control	Enables or disables the CPU's ability to enter and exit low-power states. Default: ON
Intel Turbo Boost Technology	
Enable Intel Turbo Boost Technology	Enabled or disabled the Intel TurboBoost mode of the processor. If enabled, the Intel TurboBoost driver increases the performance of the CPU or graphics processor. Default: ON
Intel Turbo Boost Maximum Technology 3.0	
Intel Hyper-Threading Technology	
Enable Intel Hyper-Threading Technology	Enabled or disabled the Intel Hyper-Threading mode of the processor. If enabled, the Intel Hyper-Threading increases the efficiency of the processor resources when multiple threads run on each core. Default: ON
Prestos 3	

Table 47. System setup options—System Logs menu

System Logs	
BIOS Event Log	
Clear Bios Event Log	Select keep or clear BIOS events. By default, Keep is selected.
Thermal Event Log	
Clear Thermal Event Log	Select keep or clear Thermal events. By default, Keep is selected.
Power Event Log	
Clear POWER Event Log	Select keep or clear Power events.

Table 47. System setup options—System Logs menu (continued)

System Logs
By default, Keep is selected.

Updating the BIOS

Updating the BIOS in Windows

About this task

CAUTION: If BitLocker is not suspended before updating the BIOS, the next time you reboot the system it will not recognize the BitLocker key. You will then be prompted to enter the recovery key to progress and the system will ask for this on each reboot. If the recovery key is not known this can result in data loss or an unnecessary operating system re-install. For more information on this subject, search in the Knowledge Base Resource at www.dell.com/support.

Steps

1. Go to www.dell.com/support.
2. Click **Product support**. In the **Search support** box, enter the Service Tag of your computer, and then click **Search**.
NOTE: If you do not have the Service Tag, use the SupportAssist feature to automatically identify your computer. You can also use the product ID or manually browse for your computer model.
3. Click **Drivers & Downloads**. Expand **Find drivers**.
4. Select the operating system installed on your computer.
5. In the **Category** drop-down list, select **BIOS**.
6. Select the latest version of BIOS, and click **Download** to download the BIOS file for your computer.
7. After the download is complete, browse the folder where you saved the BIOS update file.
8. Double-click the BIOS update file icon and follow the on-screen instructions.
For more information, search in the Knowledge Base Resource at www.dell.com/support.

Updating the BIOS in Linux and Ubuntu

To update the system BIOS on a computer that is installed with Linux or Ubuntu, see the knowledge base article [000131486](https://www.dell.com/support/000131486) at www.dell.com/support.

Updating the BIOS using the USB drive in Windows

About this task

CAUTION: If BitLocker is not suspended before updating the BIOS, the next time you reboot the system it will not recognize the BitLocker key. You will then be prompted to enter the recovery key to progress and the system will ask for this on each reboot. If the recovery key is not known this can result in data loss or an unnecessary operating system re-install. For more information on this subject, search in the Knowledge Base Resource at www.dell.com/support.

Steps

1. Follow the procedure from step 1 to step 6 in [Updating the BIOS in Windows](#) to download the latest BIOS setup program file.
2. Create a bootable USB drive. For more information, search in the Knowledge Base Resource at www.dell.com/support.
3. Copy the BIOS setup program file to the bootable USB drive.
4. Connect the bootable USB drive to the computer that needs the BIOS update.

5. Restart the computer and press **F12** .
6. Select the USB drive from the **One Time Boot Menu**.
7. Type the BIOS setup program filename and press **Enter**.
The **BIOS Update Utility** appears.
8. Follow the on-screen instructions to complete the BIOS update.

Updating the BIOS from the F12 One-Time boot menu

Update your computer BIOS using the BIOS update.exe file that is copied to a FAT32 USB drive and booting from the F12 One-Time boot menu.

About this task

 **CAUTION:** If BitLocker is not suspended before updating the BIOS, the next time you reboot the system it will not recognize the BitLocker key. You will then be prompted to enter the recovery key to progress and the system will ask for this on each reboot. If the recovery key is not known this can result in data loss or an unnecessary operating system re-install. For more information on this subject, search in the Knowledge Base Resource at www.dell.com/support.

BIOS Update

You can run the BIOS update file from Windows using a bootable USB drive or you can also update the BIOS from the F12 One-Time boot menu on the computer.

Most of the Dell computers built after 2012 have this capability, and you can confirm by booting your computer to the F12 One-Time Boot Menu to see if BIOS FLASH UPDATE is listed as a boot option for your computer. If the option is listed, then the BIOS supports this BIOS update option.

 **NOTE:** Only computers with BIOS Flash Update option in the F12 One-Time boot menu can use this function.

Updating from the One-Time boot menu

To update your BIOS from the F12 One-Time boot menu, you need the following:

- USB drive formatted to the FAT32 file system (key does not have to be bootable)
- BIOS executable file that you downloaded from the Dell Support website and copied to the root of the USB drive
- AC power adapter that is connected to the computer
- Functional computer battery to flash the BIOS

Perform the following steps to perform the BIOS update flash process from the F12 menu:

 **CAUTION:** Do not turn off the computer during the BIOS update process. The computer may not boot if you turn off your computer.

Steps

1. From a turn off state, insert the USB drive where you copied the flash into a USB port of the computer.
2. Turn on the computer and press F12 to access the One-Time Boot Menu, select BIOS Update using the mouse or arrow keys then press Enter.
The flash BIOS menu is displayed.
3. Click **Flash from file**.
4. Select external USB device.
5. Select the file and double-click the flash target file, and then click **Submit**.
6. Click **Update BIOS**. The computer restarts to flash the BIOS.
7. The computer will restart after the BIOS update is completed.

System and setup password

Table 48. System and setup password

Password type	Description
System password	Password that you must enter to log in to your system.
Setup password	Password that you must enter to access and make changes to the BIOS settings of your computer.

You can create a system password and a setup password to secure your computer.

 **CAUTION:** The password features provide a basic level of security for the data on your computer.

 **CAUTION:** Anyone can access the data that is stored on your computer if it is not locked and left unattended.

 **NOTE:** System and setup password feature is disabled.

Assigning a system setup password

Prerequisites

You can assign a new **System or Admin Password** only when the status is in **Not Set**.

About this task

To enter the system setup, press F12 immediately after a power-on or reboot.

Steps

1. In the **System BIOS** or **System Setup** screen, select **Security** and press Enter.
The **Security** screen is displayed.
2. Select **System/Admin Password** and create a password in the **Enter the new password** field.
Use the following guidelines to assign the system password:
 - A password can have up to 32 characters.
 - At least one special character: ! " # \$ % & ' () * + , - . / : ; < = > ? @ [\] ^ _ ` { | }
 - Numbers 0 through 9.
 - Upper case letters from A to Z.
 - Lower case letters from a to z.
3. Type the system password that you entered earlier in the **Confirm new password** field and click **OK**.
4. Press Esc and save the changes as prompted by the pop-up message.
5. Press Y to save the changes.
The computer restarts.

Deleting or changing an existing system setup password

Prerequisites

Ensure that the **Password Status** is Unlocked (in the System Setup) before attempting to delete or change the existing System and/or Setup password. You cannot delete or change an existing System or Setup password, if the **Password Status** is Locked.

About this task

To enter the System Setup, press F12 immediately after a power-on or reboot.

Steps

1. In the **System BIOS** or **System Setup** screen, select **System Security** and press Enter. The **System Security** screen is displayed.
2. In the **System Security** screen, verify that **Password Status** is **Unlocked**.
3. Select **System Password**, update, or delete the existing system password, and press Enter or Tab.
4. Select **Setup Password**, update, or delete the existing setup password, and press Enter or Tab.

NOTE: If you change the System and/or Setup password, reenter the new password when prompted. If you delete the System and/or Setup password, confirm the deletion when prompted.

5. Press Esc and a message prompts you to save the changes.
6. Press Y to save the changes and exit from System Setup. The computer restarts.

Clearing BIOS (System Setup) and System passwords

About this task

To clear the system or BIOS passwords, contact Dell technical support as described at www.dell.com/contactdell.

NOTE: For information on how to reset Windows or application passwords, refer to the documentation accompanying Windows or your application.

Clearing Chassis Intrusion Alerts

The system features a chassis intrusion switch which is able to detect any time the base cover has been removed from the system.

Alerts to notify you of any intrusions can be enabled via the **Chassis Intrusion** field in the **Security** sub-menu of the BIOS setup menu.

When enabled, the **Block Boot Until Cleared** field allows you to choose whether to prevent normal boot up of the system until the intrusion alert is cleared.

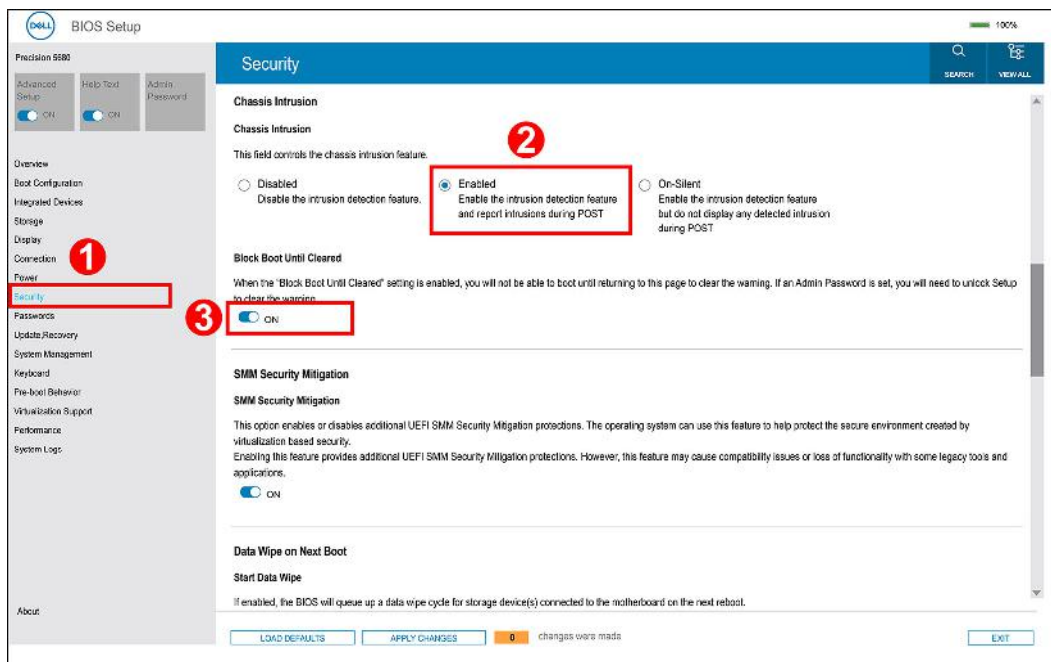

- If **Block Boot Until Cleared** is set to **ON**, the user must select **BIOS-Setup** and clear the intrusion alert in order to boot up normally.

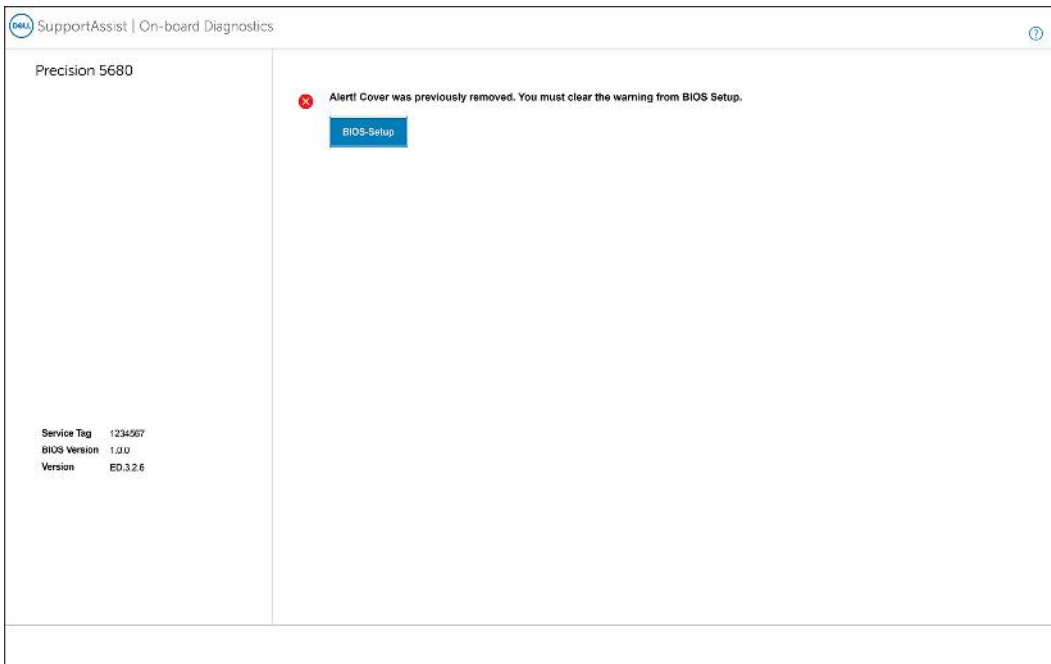

- If **Block Boot Until Cleared** is set to **OFF**, select **Continue** to boot up normally or **BIOS-Setup** to clear the alert.

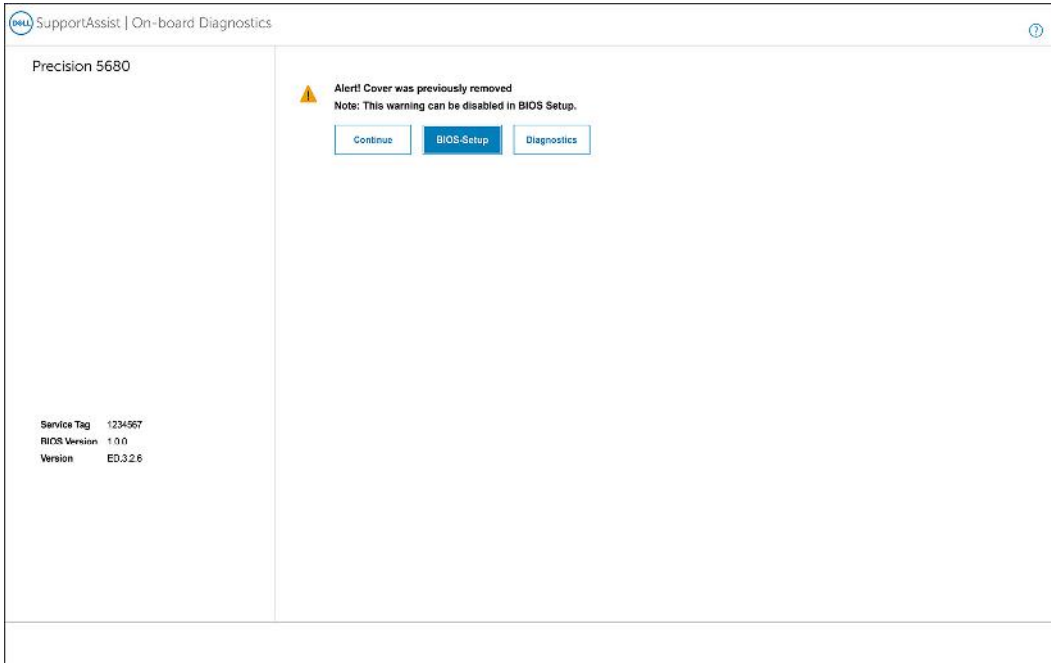

NOTE: If **Continue** is selected, the user will continue to see the alert each time the system is powered on until the alert is cleared.

To clear the alert, select **ON** in the **Clear Intrusion Warning** field in the **Security** sub-menu of the BIOS setup menu.

DELL BIOS Setup

Precision 5580

Advanced Setup: ON, Help Text: ON, Admin Password: ON

Overview, Boot Configuration, Integrated Devices, Storage, Display, Connection, Power, Security, Passwords, Update/Recovery, System Management, Keyboard, Pre-Boot Behavior, Virtualization Support, Performance, System Logs, About

Security

Chassis Intrusion

This field controls the chassis intrusion feature.

A chassis intrusion has been detected. Select "Clear Intrusion Warning" to acknowledge and clear this event. The system will then be armed to look for future security breaches.

Disabled: Disable the intrusion detection feature.
 Enabled: Enable the intrusion detection feature and report intrusions during POST.
 On-Silent: Enable the intrusion detection feature but do not display any detected intrusion during POST.

Clear Intrusion Warning
 ON

Block Boot Until Cleared
When the "Block Boot Until Cleared" setting is enabled, you will not be able to boot until returning to this page to clear the warning. If an Admin Password is set, you will need to unlock Setup to clear the warning.
 ON

SMM Security Mitigation
SMM Security Mitigation
This option enables or disables additional UEFI SMM Security Mitigation protections. The operating system can use this feature to help protect the secure environment created by virtualization based security. Enabling this feature provides additional UEFI SMM Security Mitigation protections. However, this feature may cause compatibility issues or loss of functionality with some legacy tools and applications.
 ON

LOAD DEFAULTS | APPLY CHANGES | 0 changes were made | EXIT

Troubleshooting

Handling swollen rechargeable Li-ion batteries

Like most laptops, Dell laptops use Lithium-ion batteries. One type of Lithium-ion battery is the rechargeable Li-ion battery. Rechargeable Li-ion batteries have increased in popularity in recent years and have become standard in the electronics industry due to customer preferences for a slim form factor (especially with newer ultra-thin laptops) and long battery life. Inherent to rechargeable Li-ion battery technology is the potential for swelling of the battery cells.

Swollen battery may impact the performance of the laptop. To prevent possible further damage to the device enclosure or internal components leading to malfunction, discontinue the use of the laptop and discharge it by disconnecting the AC adapter and letting the battery drain.

Swollen batteries should not be used and should be replaced and disposed of properly. We recommend contacting Dell product support for options to replace a swollen battery under the terms of the applicable warranty or service contract, including options for replacement by a Dell authorized service technician.

The guidelines for handling and replacing rechargeable Li-ion batteries are as follows:

- Exercise caution when handling rechargeable Li-ion batteries.
- Discharge the battery before removing it from the system. To discharge the battery, unplug the AC adapter from the system and operate the system only on battery power. When the system will no longer power on when the power button is pressed, the battery is fully discharged.
- Do not crush, drop, mutilate, or penetrate the battery with foreign objects.
- Do not expose the battery to high temperatures, or disassemble battery packs and cells.
- Do not apply pressure to the surface of the battery.
- Do not bend the battery.
- Do not use tools of any type to pry on or against the battery.
- If a battery gets stuck in a device as a result of swelling, do not try to free it as puncturing, bending, or crushing a battery can be dangerous.
- Do not attempt to reassemble a damaged or swollen battery into a laptop.
- Swollen batteries that are covered under warranty should be returned to Dell in an approved shipping container (provided by Dell)—this is to comply with transportation regulations. Swollen batteries that are not covered under warranty should be disposed of at an approved recycling center. Contact Dell product support at <https://www.dell.com/support> for assistance and further instructions.
- Using a non-Dell or incompatible battery may increase the risk of fire or explosion. Replace the battery only with a compatible battery purchased from Dell that is designed to work with your Dell computer. Do not use a battery from other computers with your computer. Always purchase genuine batteries from <https://www.dell.com> or otherwise directly from Dell.

Rechargeable Li-ion batteries can swell for various reasons such as age, number of charge cycles, or exposure to high heat. For more information on how to improve the performance and lifespan of the laptop battery and to minimize the possibility of occurrence of the issue, search Dell Laptop Battery in the Knowledge Base Resource at www.dell.com/support.

Locate the Service Tag or Express Service Code of your Dell computer

Your Dell computer is uniquely identified by a Service Tag or Express Service Code. To view relevant support resources for your Dell computer, we recommend entering the Service Tag or Express Service Code at www.dell.com/support.

For more information on how to find the Service Tag for your computer, see [Locate the Service Tag on your computer](#).

Dell SupportAssist Pre-boot System Performance Check diagnostics

About this task

SupportAssist diagnostics (also known as system diagnostics) performs a complete check of your hardware. The Dell SupportAssist Pre-boot System Performance Check diagnostics is embedded with the BIOS and is launched by the BIOS internally. The embedded system diagnostics provides a set of options for particular devices or device groups allowing you to:

- Run tests automatically or in an interactive mode
- Repeat tests
- Display or save test results
- Run thorough tests to introduce additional test options to provide extra information about the failed device(s)
- View status messages that inform you if tests are completed successfully
- View error messages that inform you of problems encountered during testing

 **NOTE:** Some tests for specific devices require user interaction. Always ensure that you are present at the computer terminal when the diagnostic tests are performed.

For more information, see <https://www.dell.com/support/kbdoc/000180971>.

Running the SupportAssist Pre-Boot System Performance Check

Steps

1. Turn on your computer.
2. As the computer boots, press the F12 key as the Dell logo appears.
3. On the boot menu screen, select the **Diagnostics** option.
4. Click the arrow at the bottom left corner.
Diagnostics front page is displayed.
5. Click the arrow in the lower-right corner to go to the page listing.
The items detected are listed.
6. To run a diagnostic test on a specific device, press Esc and click **Yes** to stop the diagnostic test.
7. Select the device from the left pane and click **Run Tests**.
8. If there are any issues, error codes are displayed.
Note the error code and validation number and contact Dell.

Built-in self-test (BIST)

M-BIST

M-BIST (Built In Self-Test) is the system board's built-in self-test diagnostics tool that improves the diagnostics accuracy of system board embedded controller (EC) failures.

 **NOTE:** M-BIST can be manually initiated before POST (Power On Self Test).

How to run M-BIST

 **NOTE:** M-BIST must be initiated on the system from a power-off state either connected to AC power or with battery only.

1. Press and hold both the **M** key on the keyboard and the **power button** to initiate M-BIST.
2. With both the **M** key and the **power button** held down, the battery indicator LED may exhibit two states:
 - a. OFF: No fault detected with the system board
 - b. AMBER: Indicates a problem with the system board
3. If there is a failure with the system board, the battery status LED will flash one of the following error codes for 30 seconds:

Table 49. LED error codes

Blinking Pattern		Possible Problem
Amber	White	
2	1	CPU Failure
2	8	LCD Power Rail Failure
1	1	TPM Detection Failure
2	4	Memory/RAM failure

4. If there is no failure with the system board, the LCD will cycle through the solid color screens described in the LCD-BIST section for 30 seconds and then power off.

LCD Power rail test (L-BIST)

L-BIST is an enhancement to the single LED error code diagnostics and is automatically initiated during POST. L-BIST will check the LCD power rail. If there is no power being supplied to the LCD (that is if the L-BIST circuit fails), the battery status LED will flash either an error code [2,8] or an error code [2,7].

 **NOTE:** If L-BIST fails, LCD-BIST cannot function as no power will be supplied to the LCD.

How to invoke L-BIST Test:

1. Press the power button to start the system.
2. If the system does not start up normally, look at the battery status LED:
 - If the battery status LED flashes an error code [2,7], the display cable may not be connected properly.
 - If the battery status LED flashes an error code [2,8], there is a failure on the LCD power rail of the system board, hence there is no power supplied to the LCD.
3. For cases, when a [2,7] error code is shown, check to see if the display cable is properly connected.
4. For cases when a [2,8] error code is shown, replace the system board.

LCD Built-in Self Test (BIST)

Dell laptops have a built-in diagnostic tool that helps you determine if the screen abnormality you are experiencing is an inherent problem with the LCD (screen) of the Dell laptop or with the video card (GPU) and PC settings.

When you notice screen abnormalities like flickering, distortion, clarity issues, fuzzy or blurry image, horizontal or vertical lines, color fade etc., it is always a good practice to isolate the LCD (screen) by running the Built-In Self Test (BIST).

How to invoke LCD BIST Test

1. Power off the Dell laptop.
2. Disconnect any peripherals that are connected to the laptop. Connect only the AC adapter (charger) to the laptop.
3. Ensure that the LCD (screen) is clean (no dust particles on the surface of the screen).
4. Press and hold **D** key and **Power on** the laptop to enter LCD built-in self test (BIST) mode. Continue to hold the D key, until the system boots up.
5. The screen will display solid colors and change colors on the entire screen to white, black, red, green, and blue twice.
6. Then it will display the colors white, black and red.
7. Carefully inspect the screen for abnormalities (any lines, fuzzy color or distortion on the screen).
8. At the end of the last solid color (red), the system will shut down.

 **NOTE:** Dell SupportAssist Pre-boot diagnostics upon launch, initiates an LCD BIST first, expecting a user intervention confirm functionality of the LCD.

System diagnostic lights

Battery-status light

Indicates the power and battery-charge status.

Solid white—Power adapter is connected and the battery has more than 5 percent charge.

Amber—Computer is running on battery and the battery has less than 5 percent charge.

Off

- Power adapter is connected, and the battery is fully charged.
- Computer is running on battery, and the battery has more than 5 percent charge.
- Computer is in sleep state, hibernation, or turned off.

The power and battery-status light blinks amber along with beep codes indicating failures.

For example, the power and battery-status light blinks amber two times followed by a pause, and then blinks white three times followed by a pause. This 2,3 pattern continues until the computer is turned off indicating no memory or RAM is detected.

The following table shows different power and battery-status light patterns and associated problems.

Table 50. LED codes

Diagnostic light codes	Problem description	Recommended Solution
1,1	TPM detection failure	Replace the system board.
1,2	Unrecoverable SPI flash failure	Replace the system board.
1,5	i-Fuse failure	Replace the system board.
1,6	EC internal failure	Disconnect all power source (AC, battery, coin cell) and drain flea power by pressing and holding down the power button.
2,1	Processor failure	Replace the CPU. If CPU is on-board, replace the system board.
2,2	System board: BIOS or ROM (Read-Only Memory) failure	Replace the system board.
2,3	No memory or RAM (Random-Access Memory) detected	Reseat and swap memory modules between the slots. If the problem persists, replace the memory module
2,4	Memory or RAM (Random-Access Memory) failure	Reseat and swap memory modules between the slots. If the problem persists, replace the memory module.
2,5	Invalid memory installed	Reseat and swap memory modules between the slots. If the problem persists, replace the memory module.
2,6	System board or chipset error	Replace the system board.
2,7	Display failure - SBIOS message	Replace the LCD module.
2,8	Display failure - EC detection of power rail failure	Replace the system board.
3,1	Coin-cell battery failure	Reset the CMOS battery connection. If the problem persists, replace the RTC battery.
3,2	PCI, video card/chip failure	Replace the system board.
3,3	BIOS Recovery Image not found	Flash latest BIOS version. If the problem persists, replace the system board.
3,4	Recovery image found but invalid	Flash latest BIOS version. If the problem persists, replace the system board.
3,5	Power-rail failure	Replace the system board.
3,6	System BIOS Flash incomplete	Replace the system board.

Table 50. LED codes (continued)

Diagnostic light codes	Problem description	Recommended Solution
3,7	Management Engine (ME) error	Replace the system board.

Recovering the operating system

When your computer is unable to boot to the operating system even after repeated attempts, it automatically starts Dell SupportAssist OS Recovery.

Dell SupportAssist OS Recovery is a standalone tool that is preinstalled in all Dell computers installed with Windows operating system. It consists of tools to diagnose and troubleshoot issues that may occur before your computer boots to the operating system. It enables you to diagnose hardware issues, repair your computer, back up your files, or restore your computer to its factory state.

You can also download it from the Dell Support website to troubleshoot and fix your computer when it fails to boot into their primary operating system due to software or hardware failures.

For more information about the Dell SupportAssist OS Recovery, see *Dell SupportAssist OS Recovery User's Guide* at www.dell.com/serviceabilitytools. Click **SupportAssist** and then, click **SupportAssist OS Recovery**.

Backup media and recovery options

It is recommended to create a recovery drive to troubleshoot and fix problems that may occur with Windows. Dell proposes multiple options for recovering Windows operating system on your Dell PC. For more information, see [Dell Windows Backup Media and Recovery Options](#).

Wi-Fi power cycle

About this task

If your computer is unable to access the Internet due to Wi-Fi connectivity issues a Wi-Fi power cycle procedure may be performed. The following procedure provides the instructions on how to conduct a Wi-Fi power cycle:

 **NOTE:** Some ISPs (Internet Service Providers) provide a modem/router combo device.

Steps

1. Turn off your computer.
2. Turn off the modem.
3. Turn off the wireless router.
4. Wait for 30 seconds.
5. Turn on the wireless router.
6. Turn on the modem.
7. Turn on your computer.

Drain residual flea power (perform hard reset)

About this task

Flea power is the residual static electricity that remains in the computer even after it has been powered off and the battery is removed.

For your safety, and to protect the sensitive electronic components in your computer, you are requested to drain residual flea power before removing or replacing any components in your computer.

Draining residual flea power, also known as a performing a "hard reset", is also a common troubleshooting step if your computer does not power on or boot into the operating system.

To drain residual flea power (perform a hard reset)

Steps

1. Turn off your computer.
2. Disconnect the power adapter from your computer.
3. Remove the base cover.
4. Remove the battery.
5. Press and hold the power button for 20 seconds to drain the flea power.
6. Install the battery.
7. Install the base cover.
8. Connect the power adapter to your computer.
9. Turn on your computer.





NOTE: For more information about performing a hard reset, search in the Knowledge Base Resource at www.dell.com/support.

Getting help and contacting Dell

Self-help resources

You can get information and help on Dell products and services using these self-help resources:

Table 51. Self-help resources

Self-help resources	Resource location
Information about Dell products and services	www.dell.com
My Dell app	
Tips	
Contact Support	In Windows search, type <code>Contact Support</code> , and press Enter.
Online help for operating system	www.dell.com/support/windows www.dell.com/support/linux
Access top solutions, diagnostics, drivers and downloads, and learn more about your computer through videos, manuals and documents.	Your Dell computer is uniquely identified by a Service Tag or Express Service Code. To view relevant support resources for your Dell computer, enter the Service Tag or Express Service Code at www.dell.com/support . For more information on how to find the Service Tag for your computer, see Locate the Service Tag on your computer .
Dell knowledge base articles for a variety of computer concerns	<ol style="list-style-type: none"> 1. Go to www.dell.com/support. 2. On the menu bar at the top of the Support page, select Support > Knowledge Base. 3. In the Search field on the Knowledge Base page, type the keyword, topic, or model number, and then click or tap the search icon to view the related articles.

Contacting Dell

To contact Dell for sales, technical support, or customer service issues, see www.dell.com/contactdell.

 **NOTE:** Availability varies by country/region and product, and some services may not be available in your country/region.

 **NOTE:** If you do not have an active Internet connection, you can find contact information about your purchase invoice, packing slip, bill, or Dell product catalog.