

Vostro 16 5635

Owner's Manual

Notes, cautions, and warnings

 **NOTE:** A NOTE indicates important information that helps you make better use of your product.

 **CAUTION:** A CAUTION indicates either potential damage to hardware or loss of data and tells you how to avoid the problem.

 **WARNING:** A WARNING indicates a potential for property damage, personal injury, or death.

Chapter 1: Views of Vostro 16 5635	7
Right	7
Left	7
Top	8
Front	9
Bottom	10
Chapter 2: Set up your Vostro 16 5635	11
Chapter 3: Specifications of Vostro 16 5635	13
Dimensions and weight	13
Processor	13
Chipset	14
Operating system	14
Memory	14
External ports	14
Internal slots	15
Ethernet	15
Wireless module	15
Audio	16
Storage	16
Media-card reader	17
Keyboard	17
Keyboard shortcuts	18
Camera	19
Touchpad	19
Power adapter	20
Battery	20
Display	21
Fingerprint reader (optional)	22
GPU—Integrated	22
GPU—Discrete	22
Multiple display support matrix	23
Hardware security	23
Operating and storage environment	23
Dell Support policy	23
ComfortView	24
ComfortView Plus	24
Chapter 4: Working inside your computer	25
Safety instructions	25
Before working inside your computer	25
Safety precautions	26
Electrostatic discharge—ESD protection	26

ESD field service kit	27
Transporting sensitive components.....	28
After working inside your computer.....	28
BitLocker.....	28
Recommended tools.....	28
Screw list.....	29
Major components of Vostro 16 5635.....	30
Chapter 5: Removing and installing Customer Replaceable Units (CRUs).....	32
Base cover.....	32
Removing the base cover.....	32
Installing the base cover.....	34
Fan.....	36
Removing the fan.....	36
Installing the fan.....	36
Wireless card.....	37
Removing the wireless card.....	37
Installing the wireless card.....	38
Solid-state drive.....	40
Removing the M.2 2230 solid-state drive.....	40
Installing the M.2 2230 solid-state drive.....	40
Removing the M.2 2280 solid-state drive.....	41
Installing the M.2 2280 solid-state drive.....	42
Chapter 6: Removing and installing Field Replaceable Units (FRUs).....	44
Battery.....	44
Lithium-ion battery precautions.....	44
Removing the battery.....	44
Installing the battery.....	45
Heat sink.....	46
Removing the heat sink	46
Installing the heat sink	47
Speaker.....	48
Removing the speakers.....	48
Installing the speakers.....	49
Coin-cell battery.....	51
Removing the coin-cell battery.....	51
Installing the coin-cell battery.....	52
I/O board.....	52
Removing the I/O board.....	52
Installing the I/O board.....	54
Power button with optional fingerprint reader.....	55
Removing the power button with optional fingerprint reader	55
Installing the power button with optional fingerprint reader.....	56
Power-button module.....	57
Removing the power button.....	57
Installing the power button.....	58
Power-adaptor port.....	59
Removing the power-adaptor port.....	59

Installing the power-adaptor port.....	59
Display assembly.....	60
Removing the display assembly.....	60
Installing the display assembly.....	62
Trusted Platform Module.....	63
Removing the Trusted Platform Module (TPM) board.....	63
Installing the Trusted Platform Module (TPM) board.....	64
System board.....	65
Removing the system board.....	65
Installing the system board.....	67
Touchpad.....	69
Removing the touchpad.....	69
Installing the touchpad.....	70
Palm-rest and keyboard assembly.....	71
Removing the palm-rest and keyboard assembly.....	71
Installing the palm-rest and keyboard assembly.....	72
Chapter 7: Software.....	74
Operating system.....	74
Drivers and downloads.....	74
Chapter 8: BIOS setup.....	75
Entering BIOS setup program.....	75
Navigation keys.....	75
One time boot menu.....	75
One time boot menu.....	76
System setup options.....	76
Updating the BIOS.....	85
Updating the BIOS in Windows.....	85
Updating the BIOS using the USB drive in Windows.....	85
Updating the BIOS in Linux and Ubuntu.....	86
Updating the BIOS from the F12 One-Time boot menu.....	86
System and setup password.....	86
Assigning a system setup password.....	87
Deleting or changing an existing system setup password.....	87
Clearing CMOS settings.....	88
Clearing BIOS (System Setup) and System passwords.....	88
Chapter 9: Troubleshooting.....	89
Handling swollen Lithium-ion batteries.....	89
Locate the Service Tag or Express Service Code of your Dell computer	89
Dell SupportAssist Pre-boot System Performance Check diagnostics.....	90
Running the SupportAssist Pre-Boot System Performance Check.....	90
Built-in self-test (BIST).....	90
M-BIST.....	90
LCD Power rail test (L-BIST).....	91
LCD Built-in Self Test (BIST).....	91
System-diagnostic lights.....	92
Recovering the operating system.....	92

Real-Time Clock (RTC Reset)..... 93
Backup media and recovery options..... 93
WiFi power cycle..... 93
Drain residual flea power (perform hard reset)..... 93

Chapter 10: Getting help and contacting Dell.....95

Views of Vostro 16 5635

Right



1. SD-card slot

Reads from and writes to the SD card. The computer supports the following card types:

- Secure Digital (SD)
- Secure Digital High Capacity (SDHC)
- Secure Digital Extended Capacity (SDXC)

2. USB 3.2 Gen 1 port

Connect devices such as external storage devices and printers. Provides data transfer speeds up to 5 Gbps.

3. Network port

Connect an Ethernet (RJ-45) cable from a router or a broadband modem for network or Internet access, with a transfer rate of 10/100/1000 Mbps.

4. Universal audio jack

Connect headphones or a headset (headphone and microphone combo).

5. Security-cable slot (wedge-shaped)

Connect a security cable to prevent unauthorized movement of your computer.

Left



1. Power-adaptor port

Connect a power adapter to provide power to your computer and charge the battery.

2. Power and battery-status light

Indicates the power state and battery state of the computer.

Solid white—Power adapter is connected and the battery is charging.

Solid amber—Battery charge is low or critical.

Off—Battery is fully charged.

i **NOTE:** On certain computer models, the power and battery-status light are also used for diagnostics. For more information, see the *Troubleshooting* section in your computer's *Service Manual*.

3. HDMI 1.4 port

Connect to a TV, external display or another HDMI-in enabled device. Provides video and audio output.

4. USB 3.2 Gen 1 port

Connect devices such as external storage devices and printers. Provides data transfer speeds up to 5 Gbps.

5. USB 3.2 Gen 2 Type-C port with DisplayPort 1.4 and Power Delivery

Connect devices such as external storage devices, printers, and external displays.

Supports Power Delivery that enables two-way power supply between devices. Provides up to 15 W power output that enables faster charging.

i **NOTE:** A USB Type-C to DisplayPort adapter (sold separately) is required to connect a DisplayPort device.

Top

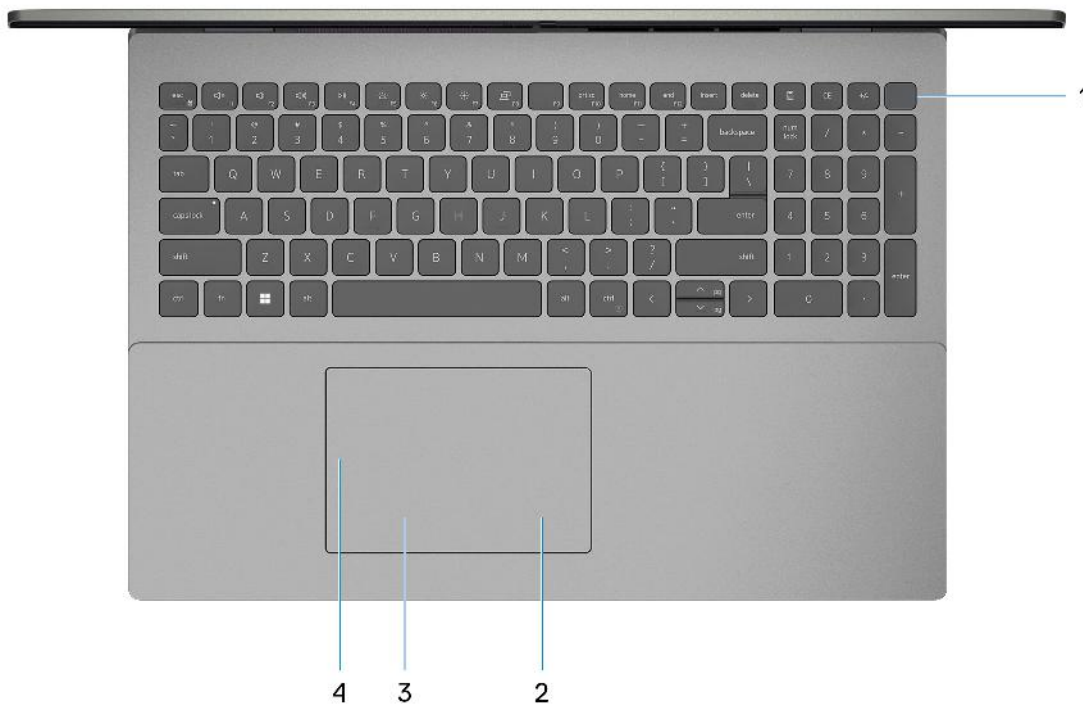

1. Power button with optional fingerprint reader

Press to turn on the computer if it is turned off, in sleep state, or in hibernate state.

When the computer is turned on, press the power button to put the computer into sleep state; press and hold the power button for 10 seconds to force shut-down the computer.

If the power button has a fingerprint reader, place your finger on the power button to log in.

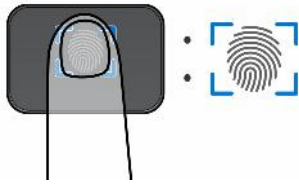

i **NOTE:** The highlighted area indicates the actual active fingerprint reader area and the image is for illustration purposes only.

i **NOTE:** The power-status light on the power button is available only on computers without the fingerprint reader. Computers that are shipped with the fingerprint reader that is integrated on the power button will not have the power-status light on the power button.

i **NOTE:** To reset the battery, press and hold the power button for 25 seconds.

2. Right-click area

Press to right-click.

i **NOTE:** The right-click area is enabled when you touch the touchpad.

3. Left-click area

Press to left-click.

i **NOTE:** The left-click area is enabled when you touch the touchpad.

4. Precision touchpad

Move your finger on the touchpad to move the mouse pointer. Tap to left-click and two fingers tap to right-click.

Front



1. Left microphone

Provides digital sound input for audio recording and voice calls.

2. Privacy shutter

Slide the privacy shutter to cover the camera lens and protect your privacy when the camera is not in use.

3. Camera

Enables you to video chat, capture photos, and record videos.

4. Camera-status light

Turns on when the camera is in use.

5. Right microphone

Provides digital sound input for audio recording and voice calls.

6. LCD panel

Provides visual output to the user.

Bottom

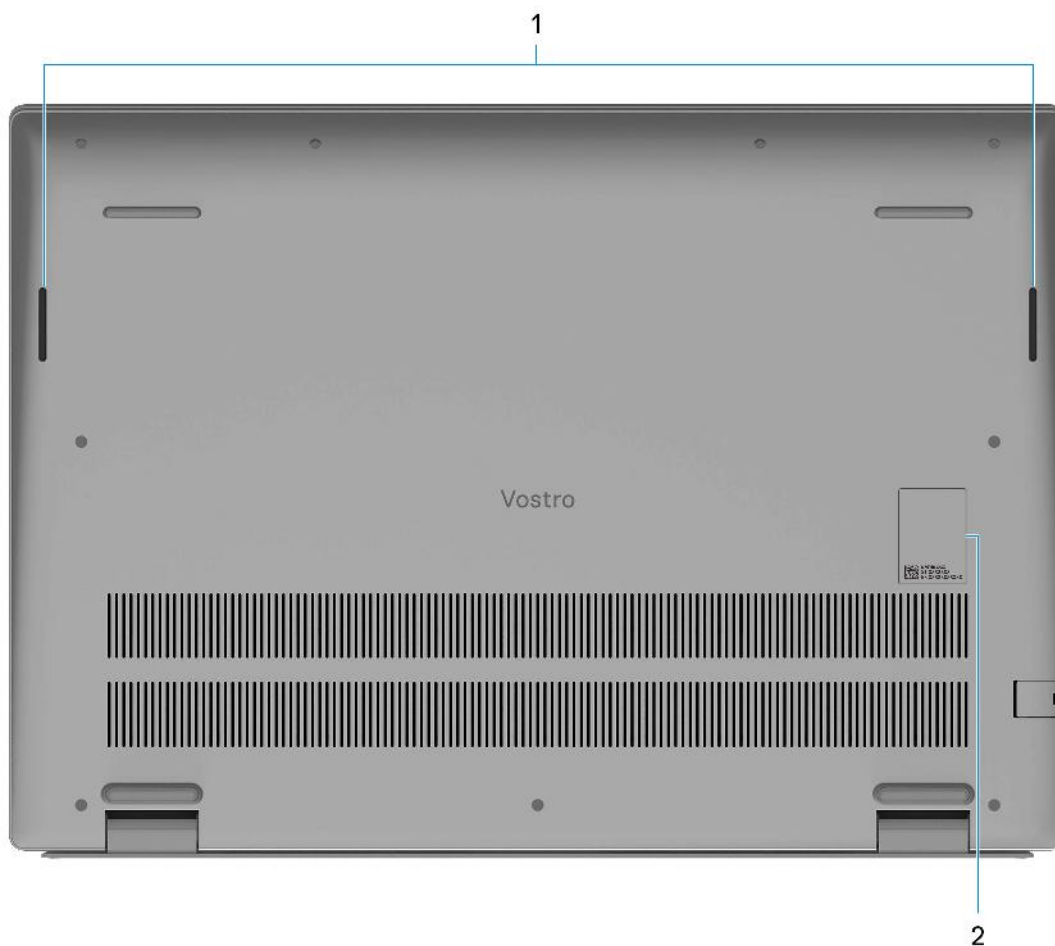

1. Speakers

Provide audio output.

2. Service Tag and regulatory labels

The Service Tag is a unique alphanumeric identifier that enables Dell service technicians to identify the hardware components in your computer and access warranty information. The regulatory label contains regulatory information of your computer.

Set up your Vostro 16 5635

About this task

NOTE: The images in this document may differ from your computer depending on the configuration you ordered.

Steps

1. Connect the power adapter and press the power button.



NOTE: The battery may go into power-saving mode during shipment to conserve charge on the battery. Ensure that the power adapter is connected to your computer when it is turned on for the first time.

2. Finish Windows setup.

Follow the on-screen instructions to complete the setup. When setting up, Dell recommends that you:





- Connect to a network for Windows updates.

NOTE: If connecting to a secured wireless network, enter the password for the wireless network access when prompted.

- If connected to the Internet, sign in with or create a Microsoft account. If not connected to the Internet, create an offline account.
- On the **Support and Protection** screen, enter your contact details.

3. Locate and use Dell apps from the Windows Start menu—Recommended.

Table 1. Locate Dell apps

Resources	Description
	<p>My Dell</p> <p>Centralized location for key Dell applications, help articles, and other important information about your computer. It also notifies you about the warranty status, recommended accessories, and software updates if available.</p>
	<p>SupportAssist</p> <p>SupportAssist proactively and predictively identifies hardware and software issues on your computer and automates the engagement process with Dell Technical support. It addresses performance and stabilization issues, prevents security threats, monitors, and detects hardware failures. For more information, see <i>SupportAssist for Home PCs User's Guide</i> at www.dell.com/serviceabilitytools. Click SupportAssist and then, click SupportAssist for Home PCs.</p> <p>NOTE: In SupportAssist, click the warranty expiry date to renew or upgrade your warranty.</p>
	<p>Dell Update</p> <p>Updates your computer with critical fixes and latest device drivers as they become available. For more information on using Dell Update, search in the Knowledge Base Resource at www.dell.com/support.</p>
	<p>Dell Digital Delivery</p> <p>Download software applications, which are purchased but not preinstalled on your computer. For more information on using Dell Digital Delivery, search in the Knowledge Base Resource at www.dell.com/support.</p>

Specifications of Vostro 16 5635

Dimensions and weight

The following table lists the height, width, depth, and weight of your Vostro 16 5635.

Table 2. Dimensions and weight

Description	Values
Height:	
Front height	15.67 mm (0.62 in.)
Rear height	17.95 mm (0.71 in.)
Width	356.78 mm (14.05 in.)
Depth	251.90 mm (9.92 in.)
Weight (maximum)	1.90 kg (4.19 lb maximum) <i>i</i> NOTE: The weight of your computer depends on the configuration ordered and manufacturing variability.

Processor

The following table lists the details of the processors supported by your Vostro 16 5635.

Table 3. Processor

Description	Option one	Option two
Processor type	AMD Ryzen 5 7530U	AMD Ryzen 7 7730U
Processor wattage	25 W	25 W
Processor core count	6	8
Processor thread count	12	16
Processor speed	Up to 4.50 GHz	Up to 4.50 GHz
Processor cache	19 MB	20 MB
Integrated graphics	Radeon Graphics	Radeon Graphics

Chipset

The following table lists the details of the chipset supported by your Vostro 16 5635.

Table 4. Chipset

Description	Values
Chipset	Integrated in processor
Processor	AMD Ryzen 5/7
DRAM bus width	128-bit
Flash EPROM	16 MB
PCIe bus	Up to Gen 3

Operating system

Your Vostro 16 5635 supports the following operating systems:

- Windows 11 Pro, 64-bit
- Windows 11 Home, 64-bit
- Windows 10 Pro, 64-bit
- Windows 10 Home, 64-bit

Memory

The following table lists the memory specifications of your Vostro 16 5635.

Table 5. Memory specifications

Description	Values
Memory slots	Two memory modules integrated with the system board
Memory type	Dual-channel LPDDR4x
Memory speed	4266 MHz
Maximum memory configuration	16 GB
Minimum memory configuration	8 GB
Memory configurations supported	<ul style="list-style-type: none">• 8 GB, 2 x 4 GB, LPDDR4x, 4266 MHz, dual-channel• 16 GB, 2 x 8 GB, LPDDR4x, 4266 MHz, dual-channel

External ports

The following table lists the external ports of your Vostro 16 5635.

Table 6. External ports

Description	Values
Network port	One RJ-45 Ethernet port

Table 6. External ports (continued)

Description	Values
USB ports	<ul style="list-style-type: none"> One USB 3.2 Gen 2 Type-C port with DisplayPort 1.4 Alt Mode/Power Delivery Two USB 3.2 Gen 1 ports
Audio port	One Universal headset jack
Video port	One HDMI 1.4 port
Media-card reader	One SD-card slot
Power-adaptor port	One 4.50 mm x 2.90 mm DC-in
Security-cable slot	One security cable slot (wedge-shaped)

Internal slots

The following table lists the internal slots of your Vostro 16 5635.

Table 7. Internal slots

Description	Values
M.2	<ul style="list-style-type: none"> One M.2 2230 slot for WLAN, Wi-Fi/Bluetooth One M.2 2230/2280 slot for solid-state drive <p>NOTE: To learn more about the features of different types of M.2 cards, search in the Knowledge Base Resource at www.dell.com/support.</p>

Ethernet

The following table lists the wired Ethernet Local Area Network (LAN) specifications of your Vostro 16 5635.

Table 8. Ethernet specifications

Description	Values
Model number	RTL8111H-CG
Transfer rate	10/100/1000 Mbps



Wireless module

The following table lists the Wireless Local Area Network (WLAN) modules supported on your Vostro 16 5635.

Table 9. Wireless module specifications

Description	Option one	Option two
Model number	MediaTek MT7921	MediaTek MT7922
Transfer rate	Up to 2400 Mbps	Up to 2400 Mbps
Frequency bands supported	2.4 GHz/5 GHz	2.4 GHz/5 GHz/6 GHz

Table 9. Wireless module specifications (continued)

Description	Option one	Option two
Wireless standards	<ul style="list-style-type: none"> • WiFi 802.11a/b/g • Wi-Fi 4 (WiFi 802.11n) • Wi-Fi 5 (WiFi 802.11ac) • Wi-Fi 6 (802.11ax) 	<ul style="list-style-type: none"> • WiFi 802.11a/b/g • Wi-Fi 4 (WiFi 802.11n) • Wi-Fi 5 (WiFi 802.11ac) • Wi-Fi 6E (802.11ax)
Encryption	<ul style="list-style-type: none"> • 64-bit/128-bit WEP • AES-CCMP • TKIP 	<ul style="list-style-type: none"> • 64-bit/128-bit WEP • AES-CCMP • TKIP
Bluetooth	Bluetooth 5.3  NOTE: Particular versions of Microsoft Windows may not support the full Bluetooth 5.3 functionality	Bluetooth 5.3  NOTE: Particular versions of Microsoft Windows may not support the full Bluetooth 5.3 functionality

Audio

The following table lists the audio specifications of your Vostro 16 5635.

Table 10. Audio specifications

Description	Values
Audio controller	Realtek ALC3254
Stereo conversion	Supported
Internal audio interface	High definition audio interface
External audio interface	Universal Audio Jack
Number of speakers	2
Internal-speaker amplifier	Supported
External volume controls	Keyboard shortcut controls
Speaker output:	
Average speaker output	2 W x 2 = 4 W
Peak speaker output	2.5 W x 2 = 5 W
Subwoofer output	Not supported
Microphone	Dual-array microphones

Storage

This section lists the storage options on your Vostro 16 5635.

Your Vostro 16 5635 supports one of the following storage configurations:

- One M.2 2230 solid-state drive
- One M.2 2280 solid-state drive

The primary drive of your Vostro 16 5635 is the M.2 drive where your operating system is installed.

Table 11. Storage specifications

Storage type	Interface type	Capacity
M.2 2230 solid-state drive	PCIe Gen3.0x4 NVMe, up to 32 Gbps	Up to 1 TB
M.2 2230 solid-state drive	PCIe Gen4.0x4 NVMe, up to 64 Gbps	Up to 1 TB
M.2 2280 solid-state drive	PCIe Gen4.0x4 NVMe, up to 64 Gbps	Up to 2 TB
M.2 2280 solid-state drive	PCIe Gen3.0x4 NVMe QLC, up to 32 Gbps	Up to 1 TB
M.2 2280 solid-state drive	PCIe Gen4.0x4 NVMe, up to 64 Gbps	Up to 2 TB
M.2 2280 solid-state drive	PCIe Gen3.0x4 NVMe QLC, up to 32 Gbps	Up to 1 TB

Media-card reader

The following table lists the media cards supported by your Vostro 16 5635.

Table 12. Media-card reader specifications

Description	Values
Media-card type	One SD card slot
Media-cards supported	<ul style="list-style-type: none"> Secure Digital (SD) Secure Digital High Capacity (SDHC) Secure Digital Extended Capacity (SDXC)
<p>NOTE: The maximum capacity supported by the media-card reader varies depending on the standard of the media card installed in your computer.</p>	

Keyboard

The following table lists the keyboard specifications of your Vostro 16 5635.

Table 13. Keyboard specifications

Description	Values
Keyboard type	<ul style="list-style-type: none"> Backlit keyboard with Numpad Standard keyboard with Numpad
Keyboard layout	QWERTY
Number of keys	<ul style="list-style-type: none"> United States and Canada: 99 keys United Kingdom: 100 keys Japan: 103 keys
Keyboard size	X=18.70 mm key pitch Y=18.05 mm key pitch
Keyboard shortcuts	Some keys on your keyboard have two symbols on them. These keys can be used to type alternate characters or to perform secondary functions. To type the alternate character,

Table 13. Keyboard specifications (continued)

Description	Values
	press Shift and the desired key. To perform secondary functions, press Fn and the desired key. ⓘ NOTE: You can define the primary behavior of the function keys (F1–F12) changing Function Key Behavior in BIOS setup program. For more information, see Keyboard shortcuts .

Keyboard shortcuts

ⓘ **NOTE:** Keyboard characters may differ depending on the keyboard language configuration. Keys used for shortcuts remain the same across all language configurations.

Some keys on your keyboard have two symbols on them. These keys can be used to type alternate characters or to perform secondary functions. The symbol shown on the lower part of the key refers to the character that is typed out when the key is pressed. If you press shift and the key, the symbol shown on the upper part of the key is typed out. For example, if you press **2**, **2** is typed out; if you press **Shift + 2**, **@** is typed out.

The keys F1-F12 at the top row of the keyboard are function keys for multi-media control, as indicated by the icon at the bottom of the key. Press the function key to invoke the task represented by the icon. For example, pressing F1 mutes the audio (refer to the table below).

However, if the function keys F1-F12 are needed for specific software applications, multi-media functionality can be disabled by pressing **fn + Esc**. Subsequently, multi-media control can be invoked by pressing **fn** and the respective function key. For example, mute audio by pressing **fn + F1**.

ⓘ **NOTE:** You can also define the primary behavior of the function keys (F1–F12) by changing **Function Key Behavior** in BIOS setup program.

Table 14. List of keyboard shortcuts

Function key	Re-defined key (for multi-media control)	Behavior
F1	fn + F1	Mute audio
F2	fn + F2	Decrease volume
F3	fn + F3	Increase volume
F4	fn + F4	Play/Pause
F5	fn + F5	Toggle keyboard backlight (optional)
F6	fn + F6	Decrease brightness
F7	fn + F7	Increase brightness
F8	fn + F8	Switch to external display
F10	fn + F10	Print screen
F11	fn + F11	Home
F12	fn + F12	End

The **fn** key is also used with selected keys on the keyboard to invoke other secondary functions.

Table 15. List of keyboard shortcuts

Function key	Behavior
fn + B	Pause/Break
fn + S	Toggle scroll lock
fn + R	System request

Table 15. List of keyboard shortcuts (continued)

Function key	Behavior
fn + T	Toggle Ultra performance mode
fn + right ctrl	Open application menu
fn + /  NOTE: Brazilian keyboard only	Open application menu
fn + Space bar	Open Emoji menu
fn + esc	Toggle fn-key lock
fn + left arrow	Home
fn + right arrow	End

Camera

The following table lists the camera specifications of your Vostro 16 5635.

Table 16. Camera specifications

Description	Values
Number of cameras	One
Camera type	RGB FHD Camera
Camera location	Front camera
Camera sensor type	CMOS-sensor technology
Camera resolution:	
Still image	2.07 megapixel
Video	1920 x 1080 (HD) at 30 fps
Diagonal viewing angle:	82 degrees

Touchpad

The following table lists the touchpad specifications of your Vostro 16 5635.

Table 17. Touchpad specifications

Description	Values
Touchpad resolution:	>300 DPI
Touchpad dimensions:	
Horizontal	115 mm (4.53 in.)
Vertical	80 mm (3.15 in.)
Touchpad gestures	For more information about touchpad gestures available on Windows, see the Microsoft knowledge base article at support.microsoft.com .

Power adapter

The following table lists the power adapter specifications of your Vostro 16 5635.

Table 18. Power adapter specifications

Description		Values
Type		65 W AC adapter, 4.50 mm barrel type
Connector dimensions:		
	External diameter	4.50 mm
	Internal diameter	2.90 mm
Input voltage		100 VAC–240 VAC
Input frequency		50 Hz–60 Hz
Input current (maximum)		1.60 A/1.70 A
Output current (continuous)		3.34 A
Rated output voltage		19.50 VDC
Temperature range:		
	Operating	0°C to 40°C (32°F to 104°F)
	Storage	-40°C to 70°C (-40°F to 158°F)
 CAUTION: Operating and storage temperature ranges may differ among components, so operating or storing the device outside these ranges may impact the performance of specific components.		



Battery

The following table lists the battery specifications of your Vostro 16 5635.

Table 19. Battery specifications

Description		Values
Battery type		4-cell polymer (54 Wh), Li-ion battery
Battery voltage		15 V
Battery weight (maximum)		0.24 kg (0.53 lb)
Battery dimensions:		
	Height	271.90 mm
	Width	82 mm
	Depth	5.75 mm
Temperature range:		
	Operating	0°C to 50°C (32°F to 122°F)

Table 19. Battery specifications (continued)

Description	Values
Storage	-20°C to 60°C (-4°F to 140°F)
Battery operating time	Varies depending on operating conditions and can significantly reduce under certain power-intensive conditions.
Battery charging time (approximate)  NOTE: Control the charging time, duration, start and end time, and so on using the Dell Power Manager application. For more information on the Dell Power Manager see, <i>Me and My Dell</i> on www.dell.com .	2hr (Express charge), 3hr (Standard charge) hours (when the computer is off)
Coin-cell battery	CR2032
 CAUTION: Operating and storage temperature ranges may differ among components, so operating or storing the device outside these ranges may impact the performance of specific components.	

Display

The following table lists the display specifications of your Vostro 16 5635.

Table 20. Display specifications

Description	Option one	Option two
Display type	Full High Definition (FHD+), ComfortView	Full High Definition (FHD+), ComfortView Plus
Touch options	No	No
Display-panel technology	Wide Viewing Angle (WVA)	Wide Viewing Angle (WVA)
Display-panel dimensions (active area):		
Height	344.68 mm (13.57 in.)	344.68 mm (13.57 in.)
Width	215.42 mm (8.48 in.)	215.42 mm (8.48 in.)
Diagonal	406.46 mm (16 in.)	406.46 mm (16 in.)
Display-panel native resolution	1920 x 1200	1920 x 1200
Luminance (typical)	250 nits	300 nits
Megapixels	2.30	2.30
Color gamut	NTSC 45%	sRGB 100%, typical
Pixels Per Inch (PPI)	141	141
Contrast ratio (min.)	<ul style="list-style-type: none"> 800:1 (minimum) 1000:1 (typical) 	<ul style="list-style-type: none"> 1000:1 (minimum) 1200:1 (typical)
Response time (max.)	35 ms	35 ms
Refresh rate	Fixed 48/60 Hz	Fixed 48/60 Hz
Horizontal view angle	<ul style="list-style-type: none"> +/- 85 degrees, typical 	<ul style="list-style-type: none"> +/- 85 degrees, typical

Table 20. Display specifications (continued)

Description	Option one	Option two
	<ul style="list-style-type: none"> +/- 80 degrees, minimum 	<ul style="list-style-type: none"> +/- 80 degrees, minimum
Vertical view angle	<ul style="list-style-type: none"> +/- 85 degrees, typical +/- 80 degrees, minimum 	<ul style="list-style-type: none"> +/- 85 degrees, typical +/- 80 degrees, minimum
Pixel pitch	0.18 mm	0.18 mm
Power consumption (maximum)	4.15 W	4.40 W
Anti-glare vs glossy finish	Anti-glare	Anti-glare

Fingerprint reader (optional)

The following table lists the specifications of the optional fingerprint-reader of your Vostro 16 5635.

Table 21. Fingerprint reader specifications

Description	Values
Fingerprint-reader sensor technology	Trans-capacitive sensing
Fingerprint-reader sensor resolution	500 dpi
Fingerprint-reader sensor pixel size	108 x 88 pixels

GPU—Integrated

The following table lists the specifications of the integrated Graphics Processing Unit (GPU) supported by your Vostro 16 5635.

Table 22. GPU—Integrated

Controller	Memory size	Processor
AMD Radeon Graphics	Shared system memory	AMD Ryzen 5/7

GPU—Discrete

The following table lists the specifications of the discrete Graphics Processing Unit (GPU) supported by your Vostro 16 5635.

Table 23. GPU—Discrete

Controller	Memory size	Memory type
No discrete graphics	Not applicable	Not applicable

Multiple display support matrix

The following table lists the multiple display support matrix for your Vostro 16 5635.

Table 24. Multiple display support matrix

Graphics Card	Direct Graphics Controller Direct Output Mode	Supported external displays with computer internal display on	Supported external displays with computer internal display off
AMD Radeon Graphics	Not applicable	3	4

Hardware security

The following table lists the hardware security of your Vostro 16 5635.

Table 25. Hardware security

Hardware security
Wedge-shaped lock slot
Windows 10 Hello - Fingerprint Reader
Hardware Trusted Platform Module 2.0
Camera privacy shutter

Operating and storage environment

This table lists the operating and storage specifications of your Vostro 16 5635.

Airborne contaminant level: G1 as defined by ISA-S71.04-1985

Table 26. Computer environment

Description	Operating	Storage
Temperature range	0°C to 35°C (32°F to 95°F)	-40°C to 65°C (-40°F to 149°F)
Relative humidity (maximum)	10% to 90% (non-condensing)	0% to 95% (non-condensing)
Vibration (maximum)*	0.66 GRMS	N/A
Shock (maximum)	110 G†	N/A
 CAUTION: Operating and storage temperature ranges may differ among components, so operating or storing the device outside these ranges may impact the performance of specific components.		

* Measured using a random vibration spectrum that simulates user environment.

† Measured using a 2 ms half-sine pulse.

Dell Support policy

For information on Dell support policy, search in the Knowledge Base Resource at www.dell.com/support.

ComfortView

 **WARNING: Prolonged exposure to blue light from the display may lead to long-term effects such as eye strain, eye fatigue, or damage to the eyes.**

Blue light is a color in the light spectrum which has a short wavelength and high energy. Chronic exposure to blue light, particularly from digital sources, may disrupt sleep patterns and cause long-term effects such as eye strain, eye fatigue, or damage to the eyes.

ComfortView mode can be enabled and configured using the Dell CinemaColor application.

ComfortView mode complies with TÜV Rheinland's requirement for low blue light software solutions.

Low blue light: Dell ComfortView software technology reduces harmful blue light emissions to make extended screen time easy on your eyes.

To reduce the risk of eye strain, it is also recommended that you:

- Position the display at a comfortable viewing distance between 20 and 28 inches (50 and 70 cm) from your eyes.
- Blink frequently to moisten your eyes, wet your eyes with water, or apply suitable eye drops.
- Look away from your display, and gaze at a distant object at 20 ft (609.60 cm) away for at least 20 seconds during each break.
- Take an extended break for 20 minutes every two hours.

ComfortView Plus

 **WARNING: Prolonged exposure to blue light from the display may lead to long-term effects such as eye strain, eye fatigue, or damage to the eyes.**

Blue light is a color in the light spectrum which has a short wavelength and high energy. Chronic exposure to blue light, particularly from digital sources, may disrupt sleep patterns and cause long-term effects such as eye strain, eye fatigue, or damage to the eyes.

The display on this computer is designed to minimize blue light and complies with TÜV Rheinland's requirement for low blue light hardware solutions.

Low blue light mode is enabled at the factory, so no further configuration is necessary.











To reduce the risk of eye strain, it is also recommended that you:

- Position the display at a comfortable viewing distance between 20 and 28 inches (50 and 70 cm) from your eyes.
- Blink frequently to moisten your eyes, wet your eyes with water, or apply suitable eye drops.
- Look away from your display, and gaze at a distant object at 20 ft (609.60 cm) away for at least 20 seconds during each break.
- Take an extended break for 20 minutes every two hours.

Working inside your computer

Safety instructions

Use the following safety guidelines to protect your computer from potential damage and to ensure your personal safety. Unless otherwise noted, each procedure included in this document assumes that you have read the safety information that shipped with your computer.

-  **WARNING:** Before working inside your computer, read the safety information that is shipped with your computer. For more safety best practices, see the Regulatory Compliance home page at www.dell.com/regulatory_compliance.
-  **WARNING:** Disconnect your computer from all power sources before opening the computer cover or panels. After you finish working inside the computer, replace all covers, panels, and screws before connecting your computer to an electrical outlet.
-  **CAUTION:** To avoid damaging the computer, ensure that the work surface is flat, dry, and clean.
-  **CAUTION:** To avoid damaging the components and cards, handle them by their edges, and avoid touching the pins and the contacts.
-  **CAUTION:** You should only perform troubleshooting and repairs as authorized or directed by the Dell technical assistance team. Damage due to servicing that is not authorized by Dell is not covered by your warranty. See the safety instructions that is shipped with the product or at www.dell.com/regulatory_compliance.
-  **CAUTION:** Before touching anything inside your computer, ground yourself by touching an unpainted metal surface, such as the metal at the back of the computer. While you work, periodically touch an unpainted metal surface to dissipate static electricity which could harm internal components.
-  **CAUTION:** When you disconnect a cable, pull it by its connector or its pull tab, not the cable itself. Some cables have connectors with locking tabs or thumbscrews that you must disengage before disconnecting the cable. When disconnecting cables, keep them evenly aligned to avoid bending the connector pins. When connecting cables, ensure that the ports and the connectors are correctly oriented and aligned.
-  **CAUTION:** Press and eject any installed card from the media-card reader.
-  **CAUTION:** Exercise caution when handling Lithium-ion batteries in laptops. Swollen batteries should not be used and should be replaced and disposed properly.
-  **NOTE:** The color of your computer and certain components may appear differently than shown in this document.

Before working inside your computer

About this task

-  **NOTE:** The images in this document may differ from your computer depending on the configuration you ordered.

Steps

1. Save and close all open files and exit all open applications.
2. Shut down your computer. For Windows operating system, click **Start** >  **Power** > **Shut down**.

 **NOTE:** If you are using a different operating system, see the documentation of your operating system for shut-down instructions.

3. Disconnect your computer and all attached devices from their electrical outlets.
4. Disconnect all attached network devices and peripherals, such as keyboard, mouse, and monitor from your computer.

 **CAUTION:** To disconnect a network cable, first unplug the cable from your computer and then unplug the cable from the network device.

5. Remove any media card and optical disc from your computer, if applicable.

Safety precautions

The safety precautions chapter details the primary steps to be taken before performing any disassembly instructions.

Observe the following safety precautions before you perform any installation or break/fix procedures involving disassembly or reassembly:

- Turn off the system and all attached peripherals.
- Disconnect the system and all attached peripherals from AC power.
- Disconnect all network cables, telephone, and telecommunications lines from the system.
- Use an ESD field service kit when working inside any to avoid electrostatic discharge (ESD) damage.
- After removing any system component, carefully place the removed component on an anti-static mat.
- Wear shoes with non-conductive rubber soles to reduce the chance of getting electrocuted.

Standby power

Dell products with standby power must be unplugged before you open the case. Systems that incorporate standby power are essentially powered while turned off. The internal power enables the system to be remotely turned on (wake on LAN) and suspended into a sleep mode and has other advanced power management features.

Unplugging, pressing and holding the power button for 15 seconds should discharge residual power in the system board.

Bonding

Bonding is a method for connecting two or more grounding conductors to the same electrical potential. This is done through the use of a field service electrostatic discharge (ESD) kit. When connecting a bonding wire, ensure that it is connected to bare metal and never to a painted or non-metal surface. The wrist strap should be secure and in full contact with your skin, and ensure that you remove all jewelry such as watches, bracelets, or rings prior to bonding yourself and the equipment.

Electrostatic discharge—ESD protection

ESD is a major concern when you handle electronic components, especially sensitive components such as expansion cards, processors, memory DIMMs, and system boards. Very slight charges can damage circuits in ways that may not be obvious, such as intermittent problems or a shortened product life span. As the industry pushes for lower power requirements and increased density, ESD protection is an increasing concern.

Due to the increased density of semiconductors used in recent Dell products, the sensitivity to static damage is now higher than in previous Dell products. For this reason, some previously approved methods of handling parts are no longer applicable.

Two recognized types of ESD damage are catastrophic and intermittent failures.

- **Catastrophic** – Catastrophic failures represent approximately 20 percent of ESD-related failures. The damage causes an immediate and complete loss of device functionality. An example of catastrophic failure is a memory DIMM that has received a static shock and immediately generates a "No POST/No Video" symptom with a beep code emitted for missing or nonfunctional memory.
- **Intermittent** – Intermittent failures represent approximately 80 percent of ESD-related failures. The high rate of intermittent failures means that most of the time when damage occurs, it is not immediately recognizable. The DIMM receives a static shock, but the tracing is merely weakened and does not immediately produce outward symptoms related to the damage. The weakened trace may take weeks or months to melt, and in the meantime may cause degradation of memory integrity, intermittent memory errors, etc.

The more difficult type of damage to recognize and troubleshoot is the intermittent (also called latent or "walking wounded") failure.

Perform the following steps to prevent ESD damage:

- Use a wired ESD wrist strap that is properly grounded. The use of wireless anti-static straps is no longer allowed; they do not provide adequate protection. Touching the chassis before handling parts does not ensure adequate ESD protection on parts with increased sensitivity to ESD damage.
- Handle all static-sensitive components in a static-safe area. If possible, use anti-static floor pads and workbench pads.
- When unpacking a static-sensitive component from its shipping carton, do not remove the component from the anti-static packing material until you are ready to install the component. Before unwrapping the anti-static packaging, ensure that you discharge static electricity from your body.
- Before transporting a static-sensitive component, place it in an anti-static container or packaging.

ESD field service kit

The unmonitored Field Service kit is the most commonly used service kit. Each Field Service kit includes three main components: anti-static mat, wrist strap, and bonding wire.

Components of an ESD field service kit

The components of an ESD field service kit are:

- **Anti-Static Mat** – The anti-static mat is dissipative and parts can be placed on it during service procedures. When using an anti-static mat, your wrist strap should be snug and the bonding wire should be connected to the mat and to any bare metal on the system being worked on. Once deployed properly, service parts can be removed from the ESD bag and placed directly on the mat. ESD-sensitive items are safe in your hand, on the ESD mat, in the system, or inside a bag.
- **Wrist Strap and Bonding Wire** – The wrist strap and bonding wire can be either directly connected between your wrist and bare metal on the hardware if the ESD mat is not required, or connected to the anti-static mat to protect hardware that is temporarily placed on the mat. The physical connection of the wrist strap and bonding wire between your skin, the ESD mat, and the hardware is known as bonding. Use only Field Service kits with a wrist strap, mat, and bonding wire. Never use wireless wrist straps. Always be aware that the internal wires of a wrist strap are prone to damage from normal wear and tear, and must be checked regularly with a wrist strap tester in order to avoid accidental ESD hardware damage. It is recommended to test the wrist strap and bonding wire at least once per week.
- **ESD Wrist Strap Tester** – The wires inside of an ESD strap are prone to damage over time. When using an unmonitored kit, it is a best practice to regularly test the strap prior to each service call, and at a minimum, test once per week. A wrist strap tester is the best method for doing this test. If you do not have your own wrist strap tester, check with your regional office to find out if they have one. To perform the test, plug the wrist-strap's bonding-wire into the tester while it is strapped to your wrist and push the button to test. A green LED is lit if the test is successful; a red LED is lit and an alarm sounds if the test fails.
- **Insulator Elements** – It is critical to keep ESD sensitive devices, such as plastic heat sink casings, away from internal parts that are insulators and often highly charged.
- **Working Environment** – Before deploying the ESD Field Service kit, assess the situation at the customer location. For example, deploying the kit for a server environment is different than for a desktop or portable environment. Servers are typically installed in a rack within a data center; desktops or portables are typically placed on office desks or cubicles. Always look for a large open flat work area that is free of clutter and large enough to deploy the ESD kit with additional space to accommodate the type of system that is being repaired. The workspace should also be free of insulators that can cause an ESD event. On the work area, insulators such as Styrofoam and other plastics should always be moved at least 12 inches or 30 centimeters away from sensitive parts before physically handling any hardware components
- **ESD Packaging** – All ESD-sensitive devices must be shipped and received in static-safe packaging. Metal, static-shielded bags are preferred. However, you should always return the damaged part using the same ESD bag and packaging that the new part arrived in. The ESD bag should be folded over and taped shut and all the same foam packing material should be used in the original box that the new part arrived in. ESD-sensitive devices should be removed from packaging only at an ESD-protected work surface, and parts should never be placed on top of the ESD bag because only the inside of the bag is shielded. Always place parts in your hand, on the ESD mat, in the system, or inside an anti-static bag.
- **Transporting Sensitive Components** – When transporting ESD sensitive components such as replacement parts or parts to be returned to Dell, it is critical to place these parts in anti-static bags for safe transport.

ESD protection summary

It is recommended to use the traditional wired ESD grounding wrist strap and protective anti-static mat at all times when servicing Dell products. In addition, it is critical to keep sensitive parts separate from all insulator parts while performing service and that they use anti-static bags for transporting sensitive components.

Transporting sensitive components

When transporting ESD sensitive components such as replacement parts or parts to be returned to Dell, it is critical to place these parts in anti-static bags for safe transport.

After working inside your computer

About this task

 **NOTE:** Leaving stray or loose screws inside your computer may severely damage your computer.

Steps

1. Replace all screws and ensure that no stray screws remain inside your computer.
2. Connect any external devices, peripherals, or cables you removed before working on your computer.
3. Replace any media cards, discs, or any other parts that you removed before working on your computer.
4. Connect your computer and all attached devices to their electrical outlets.
5. Turn on your computer.

BitLocker

 **CAUTION:** If BitLocker is not suspended before updating the BIOS, the next time you reboot the system it will not recognize the BitLocker key. You will then be prompted to enter the recovery key to progress, and the system will ask for this on each reboot. If the recovery key is not known this can result in data loss or an unnecessary operating system reinstall. For more information about this subject, For information on *updating the BIOS on Dell systems with BitLocker enabled*, search in the Knowledge Base Resource at www.dell.com/support.

 **CAUTION:** If BitLocker is not suspended, replacing parts like system board or storage drives on a system with BitLocker / Device encryption enabled will also trigger the encryption and lock the user out. The recovery key is required to regain access to Windows. The recovery key is automatically saved to the user's Microsoft Account (MSA) when the device is encrypted and can be retrieved from <https://account.microsoft.com/devices/recoverykey>

For more information, refer to Windows Support article: [Finding your BitLocker recovery key in Windows](#)

Recommended tools

The procedures in this document may require the following tools:

- Phillips screwdriver #0
- Phillips screwdriver #1
- Plastic scribe

Screw list

- NOTE:** When removing screws from a component, it is recommended to note the screw type, the quantity of screws, and then place them in a screw storage box. This is to ensure that the correct number of screws and correct screw type is restored when the component is replaced.
- NOTE:** Some computers have magnetic surfaces. Ensure that the screws are not left attached to such surfaces when replacing a component.
- NOTE:** Screw color may vary with the configuration ordered.

Table 27. Screw list



















Component	Screw type	Quantity	Screw image
Base cover	M2x7.75 - captive screws	2	
Base cover	M2x4	7	
Battery	M2x3	5	
Wireless card	M2x3	1	
Solid-state drive	M2x3	1	
Solid-state drive	M2x1.8	1	
Fan	M2x3	2	
Heat sink	captive screw	7	
System board	M2x1.8	2	
USB Type-C bracket	M2x4	2	
Power button with optional fingerprint reader	M2x3	1	
TPM Board	M2x3.5	2	
Power button	M2x3	1	
I/O board	M2x3	2	
RJ45 network-port assembly	M2x5	3	
Touchpad bracket	M1.6x2	3	

Table 27. Screw list (continued)

Component	Screw type	Quantity	Screw image
Touchpad	M2x1.8	2	
Display hinges	M2.5x5	6	

Major components of Vostro 16 5635

The following image shows the major components of Vostro 16 5635.

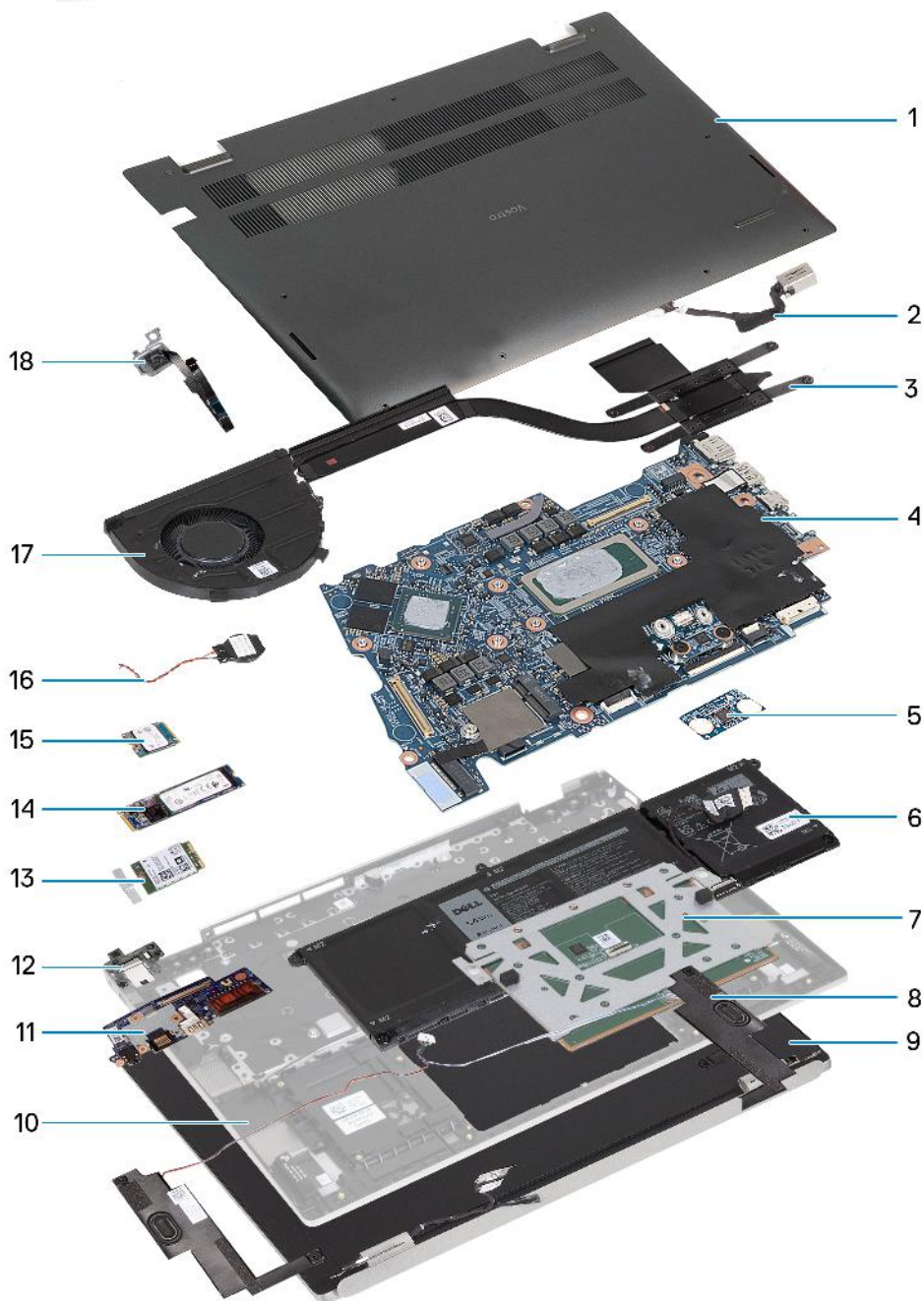

1. Base cover
2. Power-adaptor port

3. Heat sink
4. System board
5. Trusted Platform Module (TPM) board
6. Battery
7. Touchpad module
8. Speaker module
9. Display assembly
10. Palm-rest and keyboard assembly
11. I/O board
12. RJ45 bracket
13. Wireless card
14. M.2 2280 solid-state drive
15. M.2 2230 solid-state drive
16. Coin-cell battery
17. Fan
18. Fingerprint module

 **NOTE:** Dell provides a list of components and their part numbers for the original system configuration purchased. These parts are available according to warranty coverages purchased by the customer. Contact your Dell sales representative for purchase options.

Removing and installing Customer Replaceable Units (CRUs)

The replaceable components in this chapter are Customer Replaceable Units (CRUs).

 **CAUTION:** Customers can replace only the Customer Replaceable Units (CRUs) following the safety precautions and replacement procedures.

 **NOTE:** The images in this document may differ from your computer depending on the configuration you ordered.

Base cover

Removing the base cover

Prerequisites

1. Follow the procedure in [Before working inside your computer](#).

About this task

 **NOTE:** Before removing the base cover, ensure that there is no SD card installed in the SD card slot on your computer.

The following image(s) indicate the location of the base cover and provides a visual representation of the removal procedure.



2x



7x
M2x4



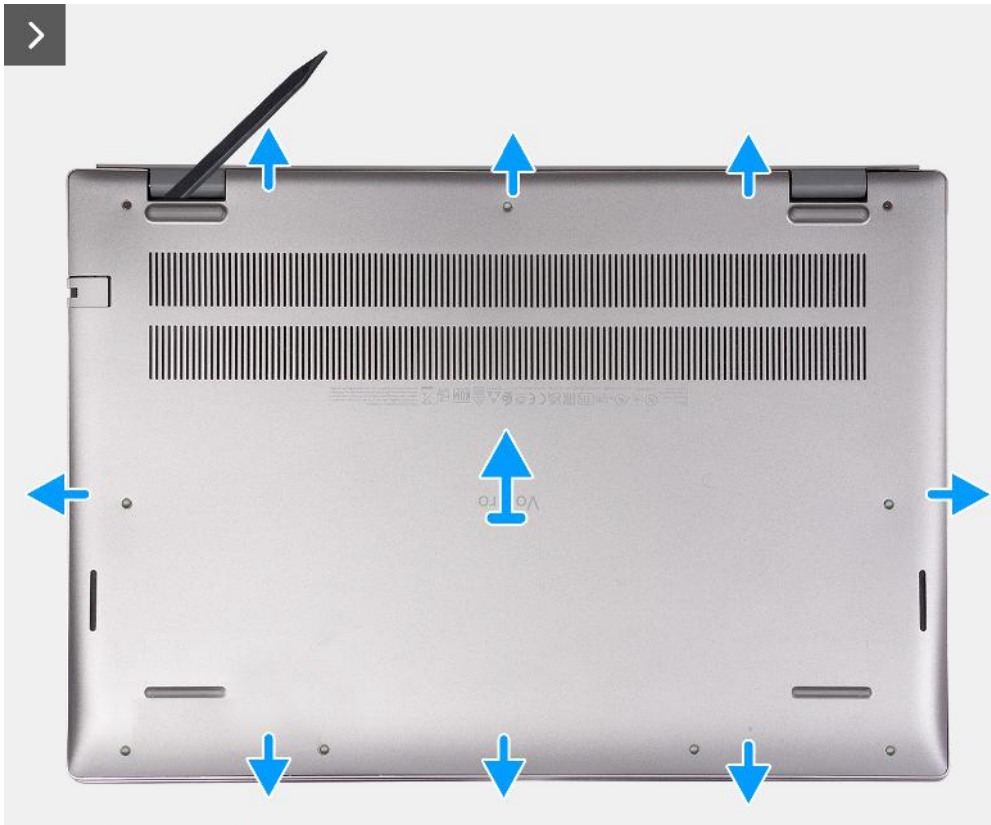

Steps

1. Remove the seven screws (M2x4) that secure the base cover to the palm-rest and keyboard assembly.
2. Loosen the two captive screws that secure the base cover to the palm-rest and keyboard assembly.
3. Using a plastic scribe, pry the base cover from the top left and continue to work on the sides to open the base cover.
4. Lift and slide the base cover off the palm-rest assembly.
5. Peel the tape that secures the battery cable to the battery.
6. Disconnect the battery cable.

Installing the base cover

Prerequisites

If you are replacing a component, remove the existing component before performing the installation process.

About this task

NOTE: The following image(s) shows the base cover and provides a visual representation of the installation procedure.

The following image(s) indicate the location of the base cover and provides a visual representation of the installation procedure.

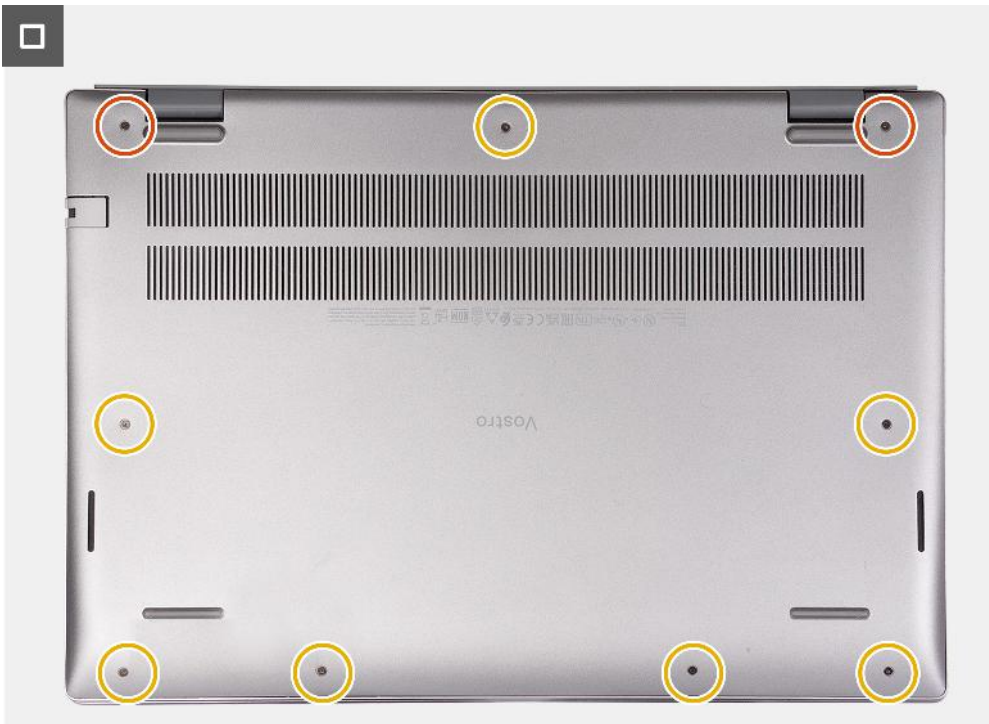
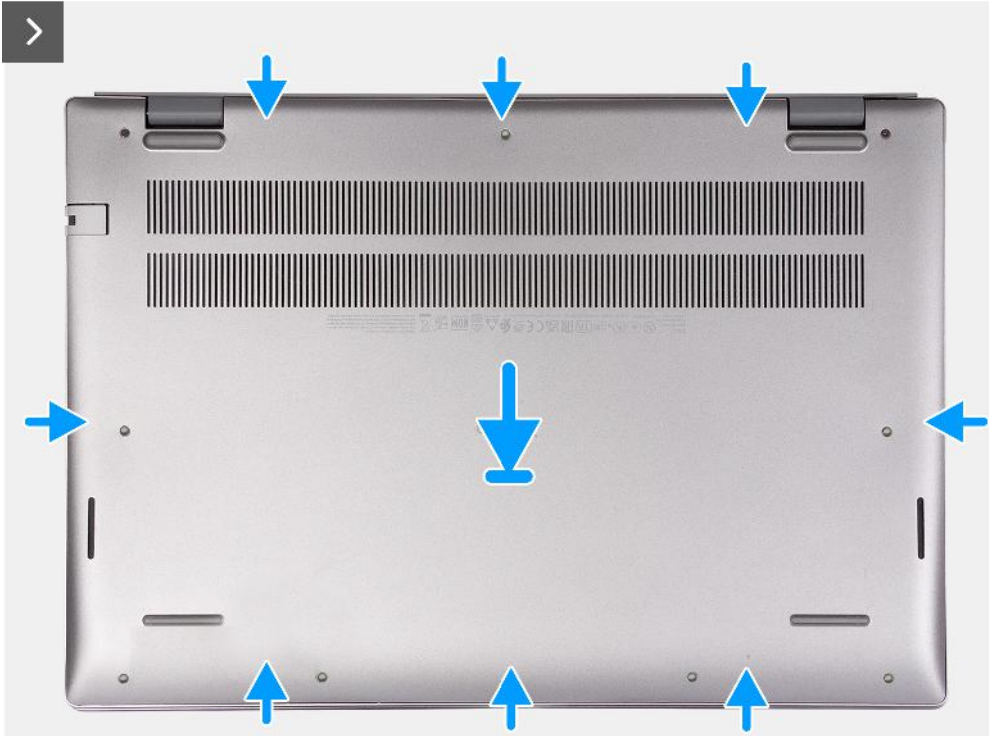

Steps

1. Ensure the battery cable has been connected to the system board.
2. Place and snap the base cover into place on the palm-rest and keyboard assembly.

3. Tighten the two captive screws on the base cover.
4. Replace the seven screws (M2x7) that secure the base cover to the palm-rest and keyboard assembly.

Next steps

1. Follow the procedure in [After working inside your computer](#).

Fan

Removing the fan

Prerequisites

1. Follow the procedure in [Before working inside your computer](#).
2. Remove the [base cover](#).

About this task

 **NOTE:** Before removing the base cover, ensure that there is no SD card installed in the SD card slot on your computer.

The following image(s) indicate the location of the fan and provides a visual representation of the removal procedure.

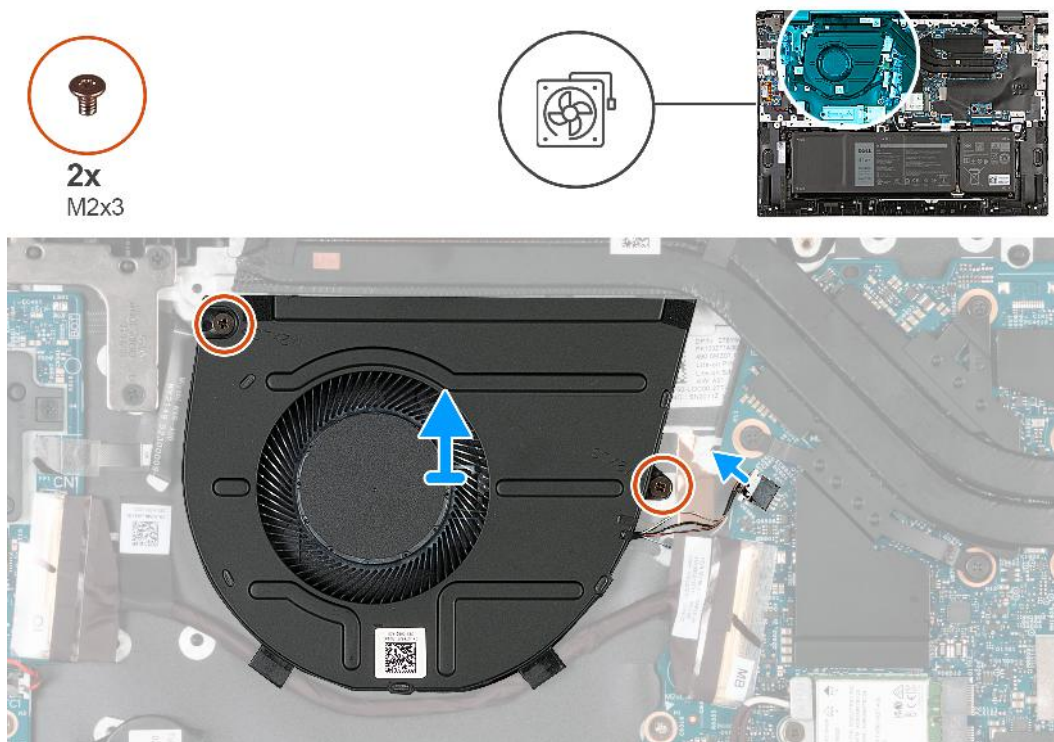

Steps

1. Disconnect the fan cable from the system board.
2. Remove the two screws (M2x3) that secure the left fan to the palm-rest and keyboard assembly.
3. Lift the fan off the palm-rest and keyboard assembly.

Installing the fan

Prerequisites

If you are replacing a component, remove the existing component before performing the installation process.

About this task

The following image(s) indicate the location of the fan and provides a visual representation of the installation procedure.



2x
M2x3

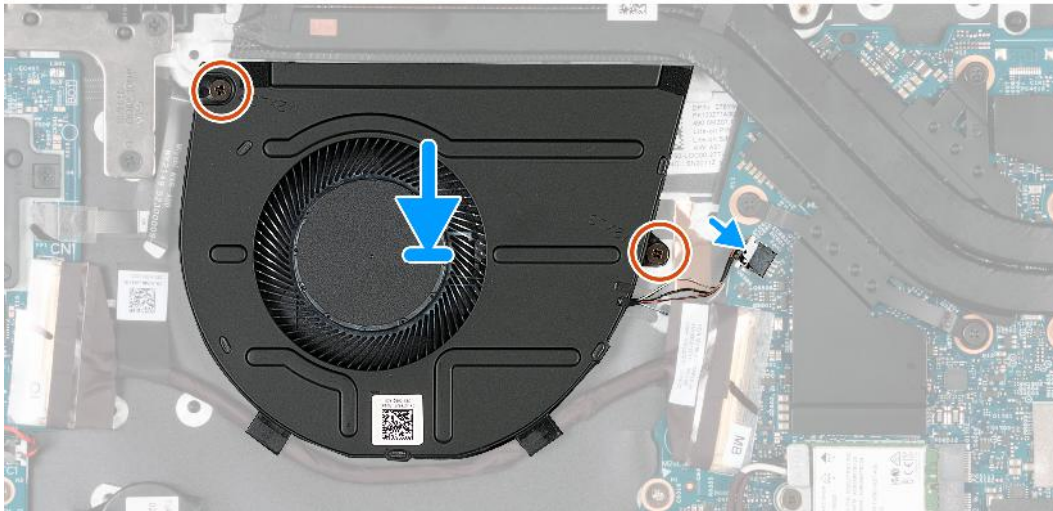
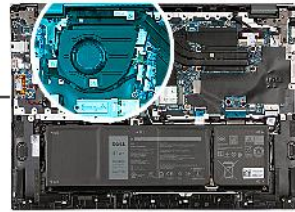
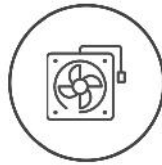

Steps

1. Align the screw holes of the fan with the screw holes on the palm-rest and keyboard assembly.
2. Replace the two screws (M2x3) that secure the fan to the palm-rest and keyboard assembly.
3. Connect the fan cable to the system board.

Next steps

1. Install the [base cover](#).
2. Follow the procedure in [After working inside your computer](#).

Wireless card

Removing the wireless card

Prerequisites

1. Follow the procedure in [Before working inside your computer](#).
2. Remove the [base cover](#).

About this task

 **NOTE:** Before removing the base cover, ensure that there is no SD card installed in the SD card slot on your computer.

The following image(s) indicate the location of the wireless card and provides a visual representation of the removal procedure.



1x
M2x3



Steps

1. Remove the screw (M2x3) that secures the wireless-card bracket to the system board.
2. Lift the wireless-card bracket off the wireless card.
3. Disconnect the antenna cables from the wireless card.
4. Slide and remove the wireless card from the wireless-card slot.

Installing the wireless card

Prerequisites

If you are replacing a component, remove the existing component before performing the installation process.

About this task

The following image(s) indicate the location of the wireless card and provides a visual representation of the installation procedure.



1x
M2x3

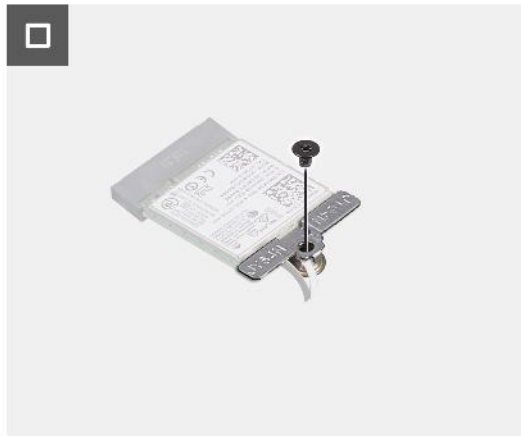

Steps

1. Align the notch on the wireless card with the tab on the wireless-card slot and insert the wireless card at an angle into the wireless-card slot.
2. Connect the antenna cables to the wireless card.
3. Align and place the wireless-card bracket on the wireless card.
4. Replace the screw (M2x3) that secures the wireless-card bracket to the system board and palm-rest and keyboard assembly.

Next steps

1. Install the [base cover](#).
2. Follow the procedure in [After working inside your computer](#).

Solid-state drive

Removing the M.2 2230 solid-state drive

Prerequisites

1. Follow the procedure in [Before working inside your computer](#).
2. Remove the [base cover](#).

About this task

- NOTE:** Before removing the base cover, ensure that there is no SD card installed in the SD card slot on your computer.
- NOTE:** If you are replacing the M.2 2230 solid-state drive with an M.2 2280 solid-state drive, the following images indicate how to remove the M.2 2230 solid-state drive from the M.2 2230 solid-state drive bracket.
- NOTE:** Device Encryption will be triggered when either the system board or storage (SSD) is replaced. Refer to [BitLocker](#) for more information on suspending BitLocker.

The following image(s) indicate the location of the M.2 2230 solid-state drive and provides a visual representation of the removal procedure.

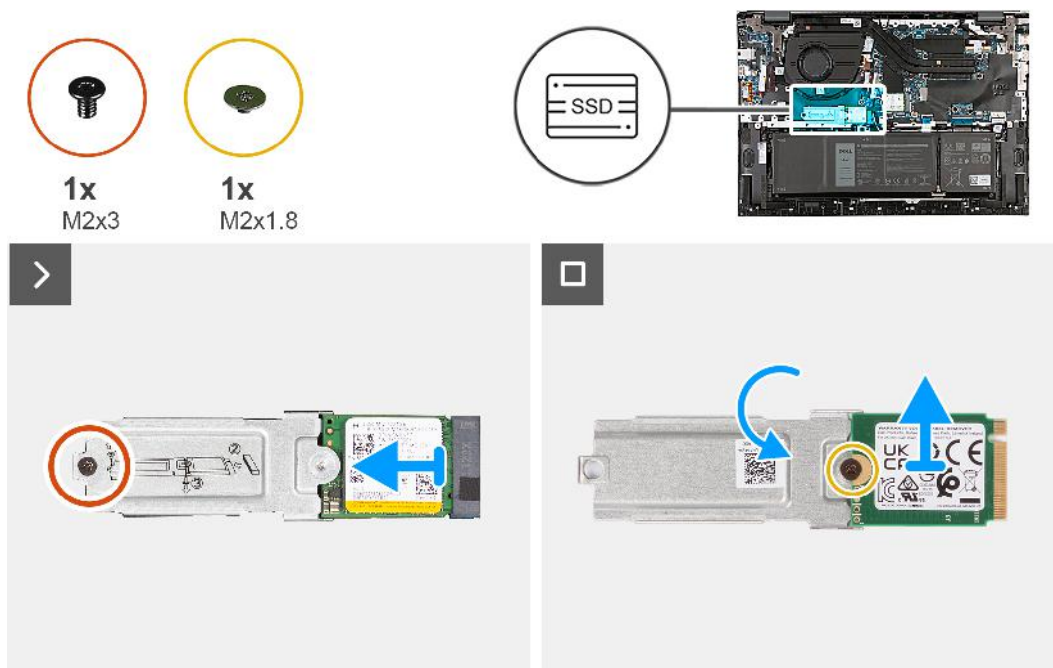

Steps

1. Remove the M2x3 screw that secures the M.2 2230 solid-state drive with bracket from the solid-state drive slot.
2. Slide the M.2 2230 solid-state drive with bracket from the peg and lift it from the system board.
3. Remove the M2x1.8 screw that secures the M.2 2230 solid-state drive to the M.2 solid-state drive bracket.
4. Lift the M.2 2230 solid-state drive off the M.2 solid-state drive bracket.

Installing the M.2 2230 solid-state drive

Prerequisites

If you are replacing a component, remove the existing component before performing the installation process.

About this task

NOTE: This computer supports two solid-state drive form factors.

- M.2 2230
- M.2 2280

If you are replacing the M.2 2280 solid-state drive with an M.2 2230 solid-state drive, the following images indicate how to install the solid-state drive bracket to the M.2 2230 solid-state drive card before installing the 2230 solid-state drive to the computer.

The following image(s) indicate the location of the M.2 2230 solid-state drive and provides a visual representation of the installation procedure.

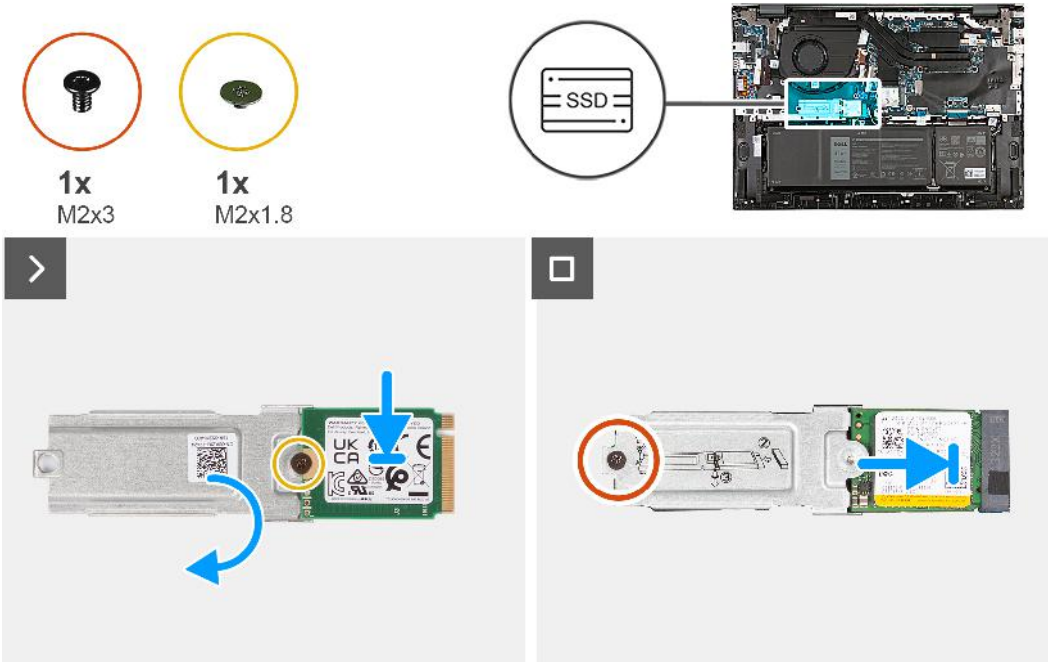

Steps

1. With the printed side of the solid-state drive facing up, align the screw hole on the M.2 2230 solid-state drive with the screw hole on the M.2 solid-state drive bracket.
2. Secure the M.2 2230 solid-state drive to the M.2 solid-state drive bracket with a M2x1.8 screw.
3. Align the notch on the M.2 2230 solid-state drive with the tab on the solid-state drive slot.
4. Gently slide the M.2 2230 solid-state drive with bracket into the solid-state drive slot.
5. Replace the screw (M2x3) that secures the M.2 solid-state drive with bracket to the system board.

Next steps

1. Install the [base cover](#).
2. Follow the procedure in [After working inside your computer](#).

Removing the M.2 2280 solid-state drive

Prerequisites

1. Follow the procedure in [Before working inside your computer](#).
2. Remove the [base cover](#).

About this task

NOTE: Before removing the base cover, ensure that there is no SD card installed in the SD card slot on your computer.

NOTE: Device Encryption will be triggered when either the system board or storage (SSD) is replaced. Refer to [BitLocker](#) for more information on suspending BitLocker

The following image(s) indicate the location of the M.2 2280 solid-state drive and provides a visual representation of the removal procedure.

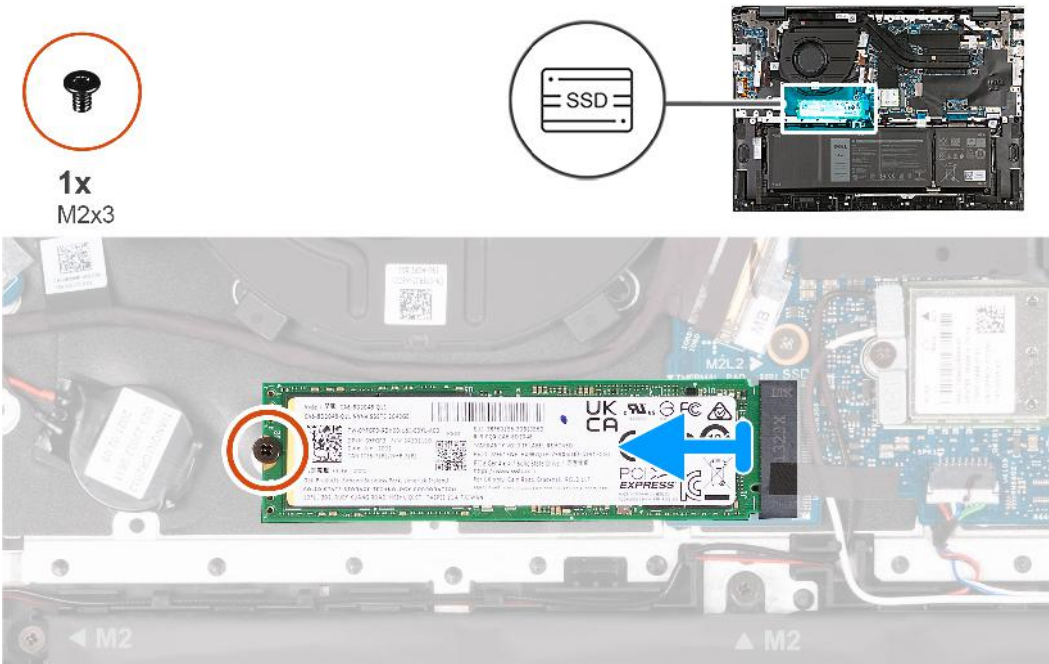

Steps

1. Remove the screw (M2x3) that secures the M.2 2280 solid-state drive to the system board.
2. Slide and remove the M.2 2280 solid-state drive from the solid-state drive slot.

Installing the M.2 2280 solid-state drive

Prerequisites

If you are replacing a component, remove the existing component before performing the installation process.

About this task

The following image(s) indicate the location of the M.2 2280 solid-state drive and provides a visual representation of the installation procedure.



1x
M2x3



Steps

1. Align the notch on the M.2 2280 solid-state drive with the tab on the solid-state drive slot.
2. Gently slide the M.2 2280 solid-state drive into the solid-state drive slot.
3. Replace the screw (M2x3) that secures the M.2 2280 solid-state drive to the system board.

Next steps

1. Install the [base cover](#).
2. Follow the procedure in [After working inside your computer](#).

Removing and installing Field Replaceable Units (FRUs)

The replaceable components in this chapter are Field Replaceable Units (FRUs).

CAUTION: The information in this section is intended for authorized service technicians only.

CAUTION: To avoid any potential damage to the component or loss of data, ensure that an authorized service technician replaces the Field Replaceable Units (FRUs).

CAUTION: Dell Technologies recommends that this set of repairs, if needed, to be conducted by trained technical repair specialists.

CAUTION: As a reminder, your warranty does not cover damages that may occur during the courses of FRU repairs that are not authorized by Dell Technologies.

NOTE: The images in this document may differ from your computer depending on the configuration you ordered.

Battery

Lithium-ion battery precautions

CAUTION:

- Exercise caution when handling Lithium-ion batteries.
- Discharge the battery completely before removing it. Disconnect the AC power adapter from the system and operate the computer solely on battery power—the battery is fully discharged when the computer no longer turns on when the power button is pressed.
- Do not crush, drop, mutilate, or penetrate the battery with foreign objects.
- Do not expose the battery to high temperatures, or disassemble battery packs and cells.
- Do not apply pressure to the surface of the battery.
- Do not bend the battery.
- Do not use tools of any kind to pry on or against the battery.
- Ensure any screws during the servicing of this product are not lost or misplaced, to prevent accidental puncture or damage to the battery and other system components.
- If the battery gets stuck inside your computer as a result of swelling, do not try to release it as puncturing, bending, or crushing a lithium-ion battery can be dangerous. In such an instance, contact Dell technical support for assistance. See www.dell.com/contactdell.
- Always purchase genuine batteries from www.dell.com or authorized Dell partners and resellers.
- Swollen batteries should not be used and should be replaced and disposed properly. For guidelines on how to handle and replace swollen Lithium-ion batteries, see [Handling swollen Lithium-ion batteries](#).

Removing the battery

Prerequisites

CAUTION: The information in this section is intended for authorized service technicians only.

1. Follow the procedure in [Before working inside your computer](#).
2. Remove the [base cover](#).

About this task

NOTE: Before removing the base cover, ensure that there is no SD card installed in the SD card slot on your computer.

The following image(s) indicate the location of the battery and provides a visual representation of the removal procedure.

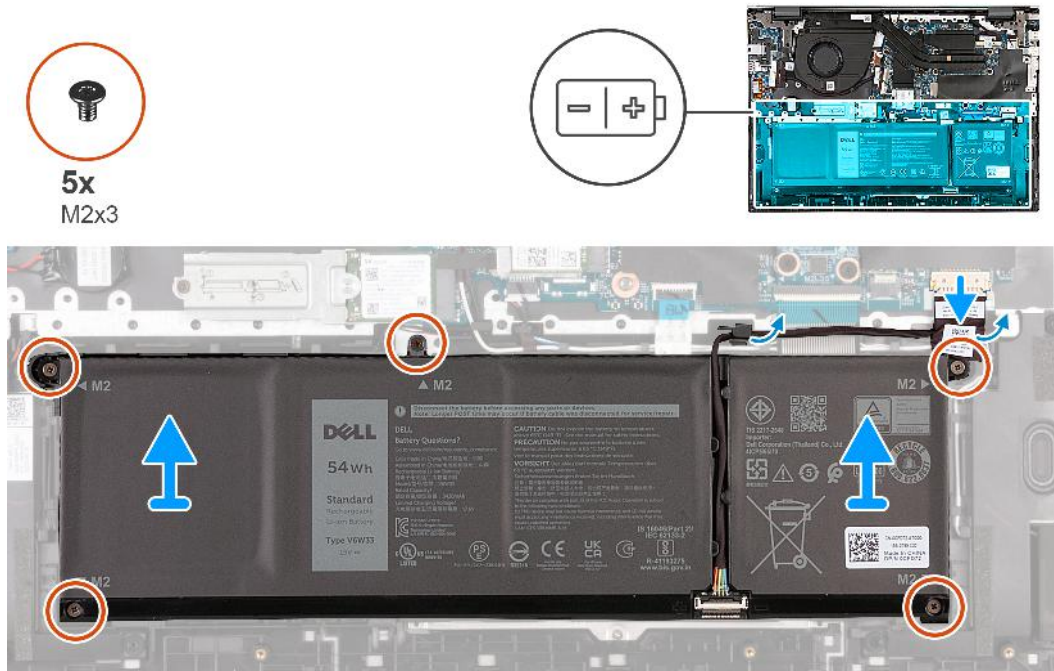

Steps

1. Peel the tape that secures the battery cable to the battery.
2. Disconnect the battery cable and disengage it from the tabs on the system board.
3. Remove the five screws (M2x3) that secure the battery to the palm-rest and keyboard assembly.
4. Lift the battery off the palm-rest and keyboard assembly.

Installing the battery

Prerequisites

CAUTION: The information in this section is intended for authorized service technicians only.

If you are replacing a component, remove the existing component before performing the installation process.

About this task

The following image(s) indicate the location of the battery and provides a visual representation of the installation procedure.



5x
M2x3

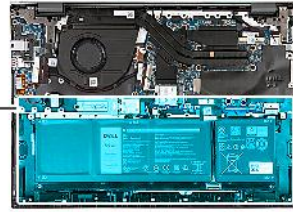
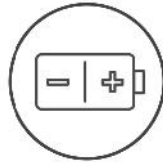

Steps

1. Align the screw holes on the battery with the screw holes on the palm-rest and keyboard assembly.
2. Replace the five screws (M2x3) that secure the battery to the palm-rest and keyboard assembly.
3. Route the battery cable through the tabs and reconnect it to the system board.
4. Adhere the tape that secures the battery cable to the battery.

Next steps

1. Install the [base cover](#).
2. Follow the procedure in [After working inside your computer](#).

Heat sink

Removing the heat sink

Prerequisites

⚠ CAUTION: The information in this section is intended for authorized service technicians only.

1. Follow the procedure in [Before working inside your computer](#).
2. Remove the [base cover](#).

About this task

i NOTE: Before removing the base cover, ensure that there is no SD card installed in the SD card slot on your computer.

The following image(s) indicate the location of the heat sink and provides a visual representation of the removal procedure.

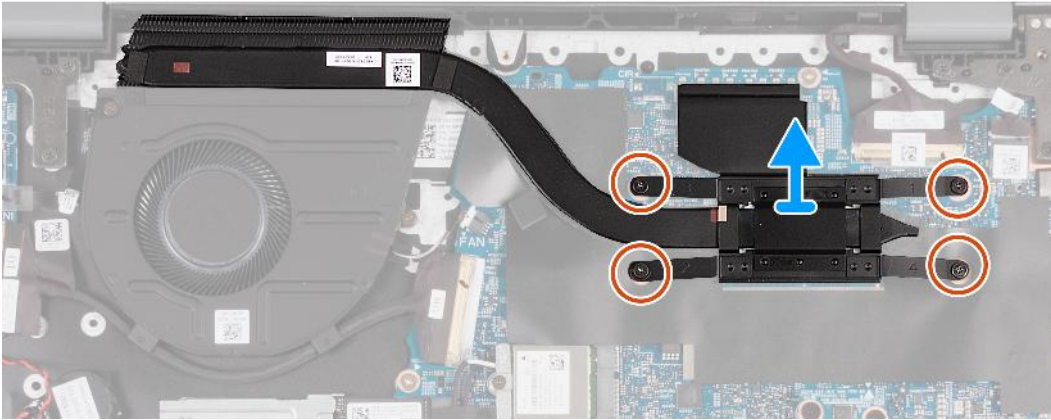
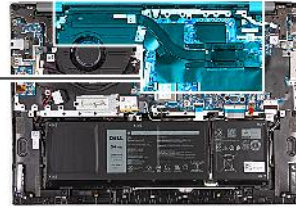

Steps

1. In reverse sequential order (4>3>2>1), loosen the four captive screws that secure the heat sink to the system board.
2. Lift the heat sink off the system board.

Installing the heat sink

Prerequisites

CAUTION: The information in this section is intended for authorized service technicians only.

If you are replacing a component, remove the existing component before performing the installation process.

About this task

The following image(s) indicate the location of the heat sink and provides a visual representation of the installation procedure.

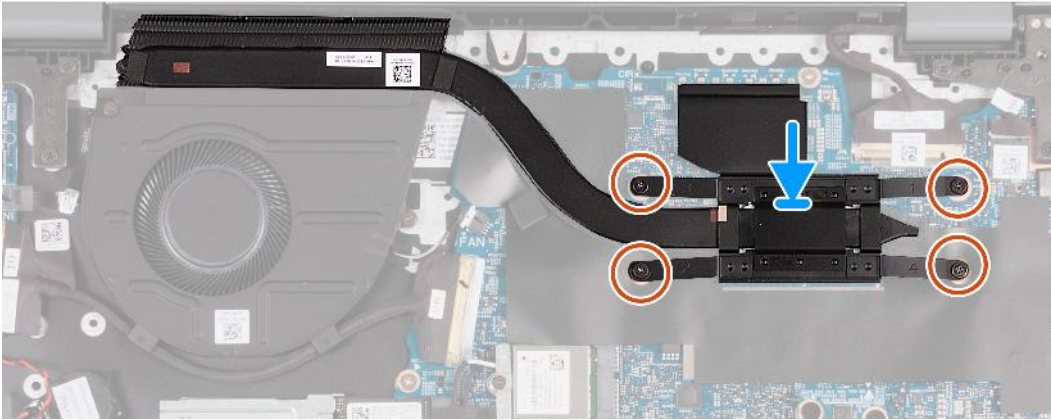
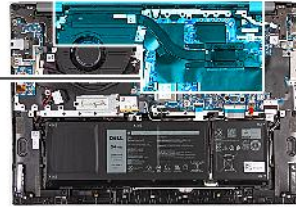

Steps

1. Align the captive screws on the heat sink to the screw holes on the system board.
2. In sequential order (1>2>3>4), tighten the four captive screws that secure the heat sink to the system board.

Next steps

1. Install the [base cover](#).
2. Follow the procedure in [After working inside your computer](#).

Speaker

Removing the speakers

Prerequisites

CAUTION: The information in this section is intended for authorized service technicians only.

1. Follow the procedure in [Before working inside your computer](#).
2. Remove the [base cover](#).
3. Remove the [battery](#).

About this task

NOTE: Before removing the base cover, ensure that there is no SD card installed in the SD card slot on your computer.

The following image(s) indicate the location of the speakers and provides a visual representation of the removal procedure.

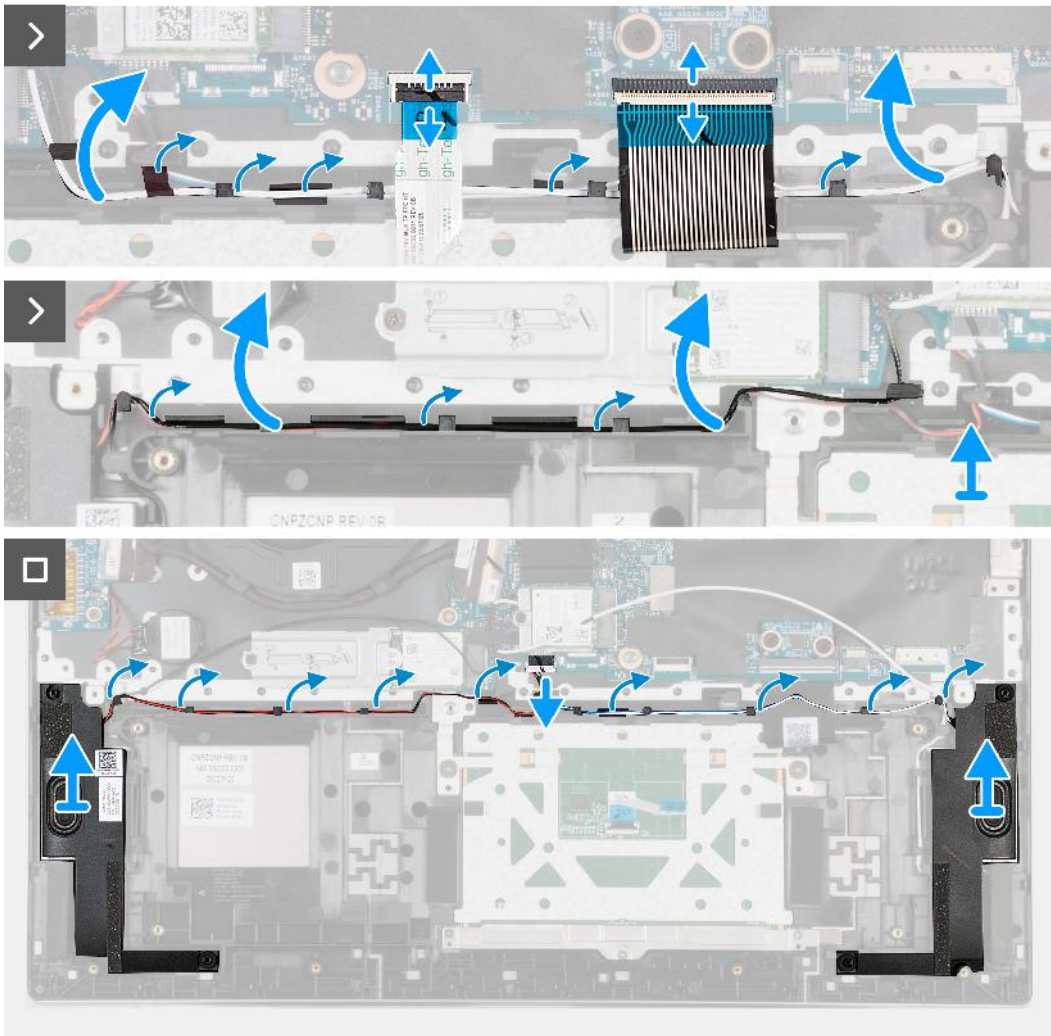
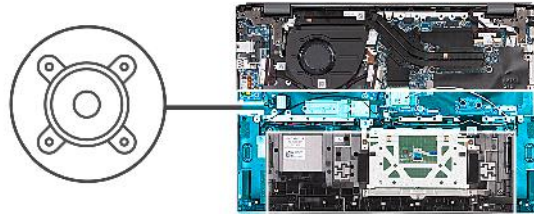

Steps

1. Open the latch and disconnect the touchpad cable from the system board.
2. Open the latch and disconnect the keyboard cable from the system board.
3. Peel the tapes that secure the WLAN cable to the system board.
4. Remove the WLAN cable from the routing guides on the palm-rest and keyboard assembly.
5. Remove the speaker cable from the routing guides on the palm-rest and keyboard assembly.
6. Lift the speakers along with their cables off the palm-rest and keyboard assembly.

Installing the speakers

Prerequisites

⚠ CAUTION: The information in this section is intended for authorized service technicians only.

If you are replacing a component, remove the existing component before performing the installation process.

About this task

The following image(s) indicate the location of the speakers and provides a visual representation of the installation procedure.

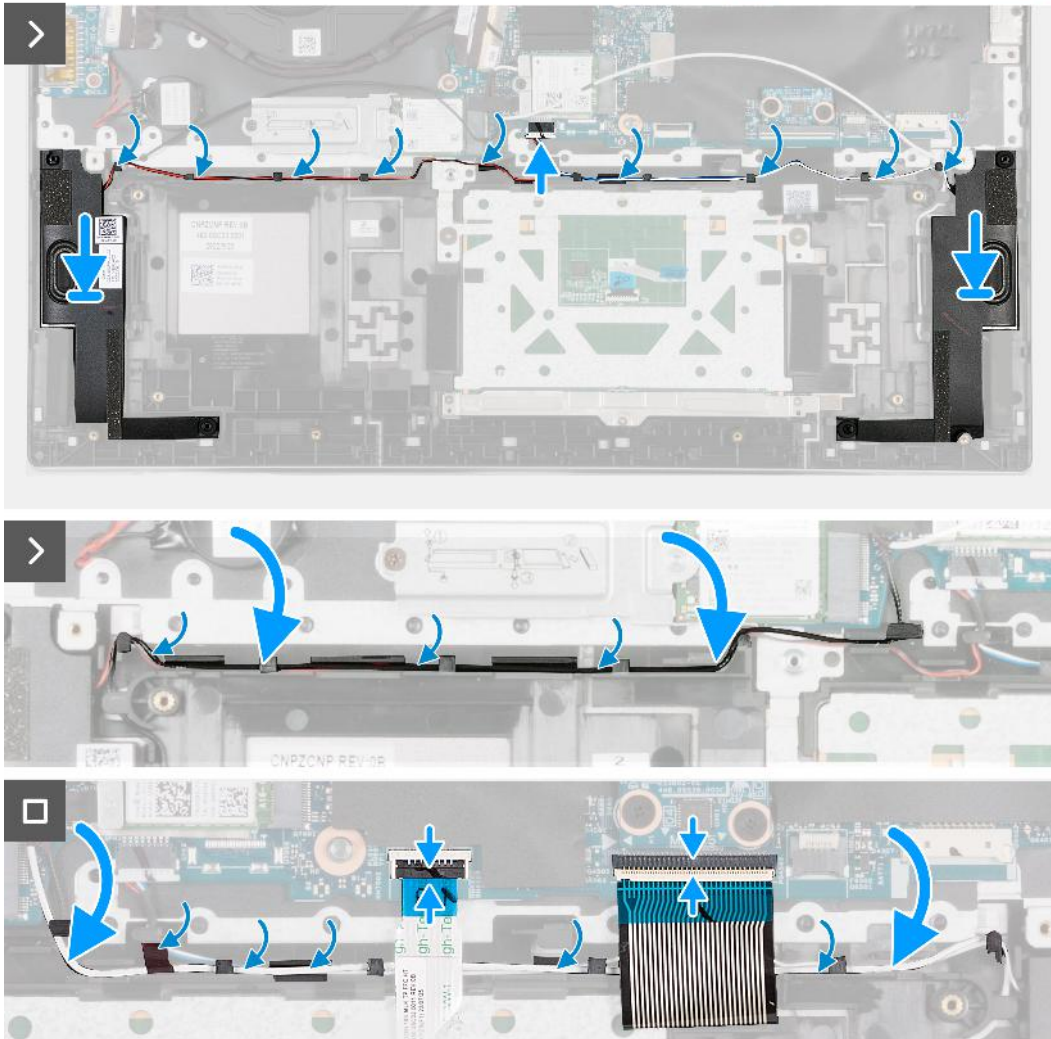
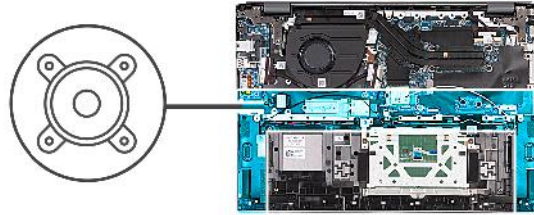

Steps

1. Using the alignment posts, place the speakers (woofers) on the palm-rest and keyboard assembly.
2. Ensure that the alignment posts are threaded through the rubber grommets on the speaker.
3. Route the speaker cable through the routing guides on the palm-rest and keyboard assembly.
4. Route the WLAN cable through the routing guides on the palm-rest and keyboard assembly.
5. Adhere the tapes that secure the WLAN cable to the system board.
6. Connect the keyboard cable to the system board and close the latch.
7. Connect the touchpad cable to the system board and close the latch.

Next steps

1. Install the [battery](#).
2. Install the [base cover](#).
3. Follow the procedure in [After working inside your computer](#).

Coin-cell battery

Removing the coin-cell battery

Prerequisites

CAUTION: The information in this section is intended for authorized service technicians only.

1. Follow the procedure in [Before working inside your computer](#).
2. Remove the [base cover](#).

About this task

NOTE: Before removing the base cover, ensure that there is no SD card installed in the SD card slot on your computer.

The following image(s) indicate the location of the coin-cell battery and provides a visual representation of the removal procedure.

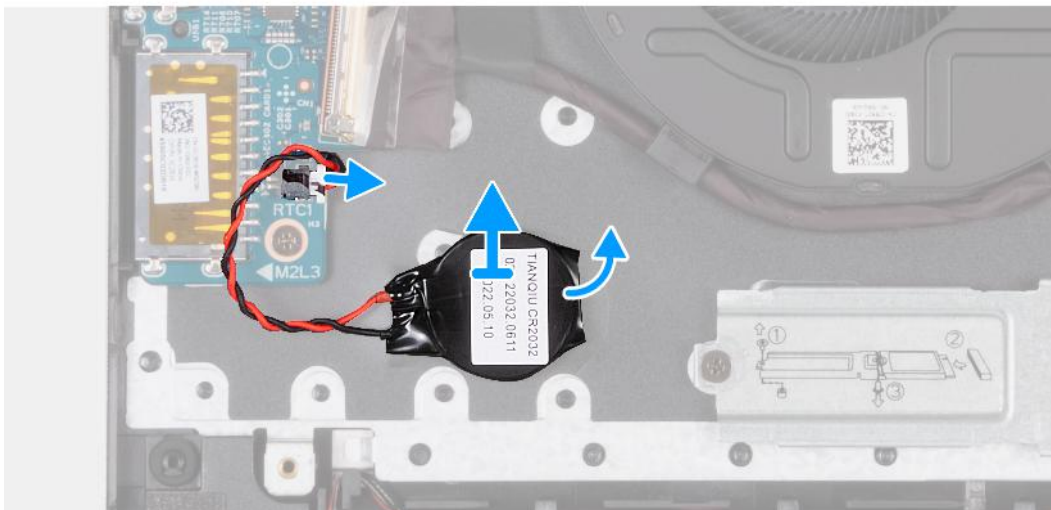
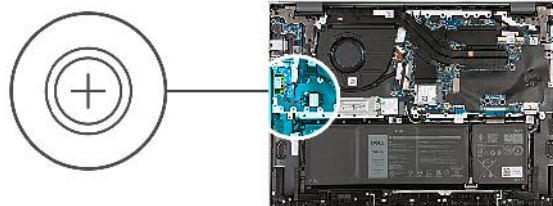

Steps

1. Disconnect the coin-cell battery cable from the system board.
2. Lift and remove the coin-cell battery off the system board.

Installing the coin-cell battery

Prerequisites

CAUTION: The information in this section is intended for authorized service technicians only.

If you are replacing a component, remove the existing component before performing the installation process.

About this task

The following image(s) indicate the location of the coin-cell battery and provides a visual representation of the installation procedure.

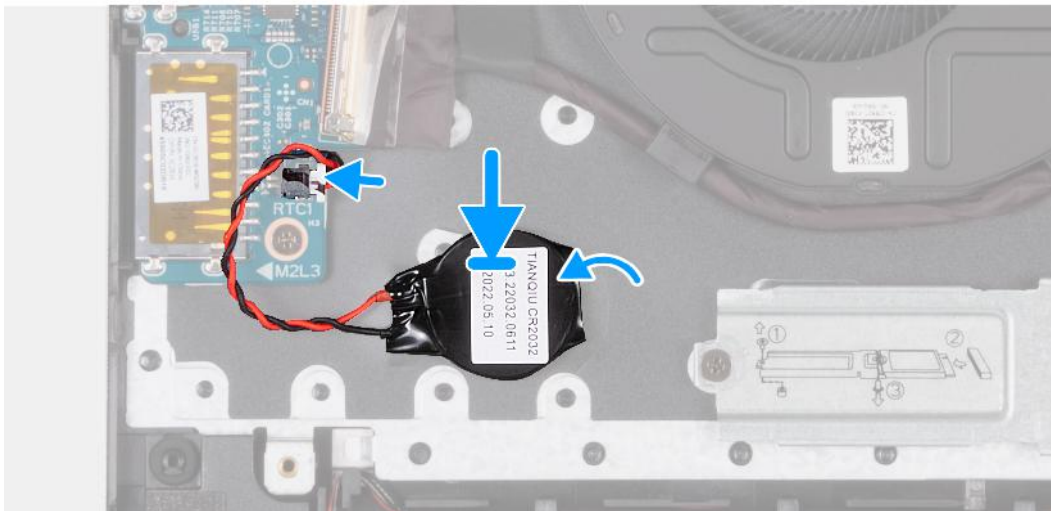
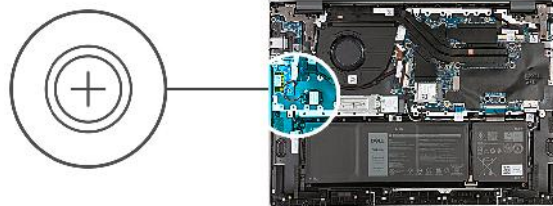

Steps

1. Adhere the coin-cell battery to the system board.
2. Connect the coin-cell battery cable to the system board.

Next steps

1. Install the [base cover](#).
2. Follow the procedure in [After working inside your computer](#).

I/O board

Removing the I/O board

Prerequisites

CAUTION: The information in this section is intended for authorized service technicians only.

1. Follow the procedure in [Before working inside your computer](#).
2. Remove the [base cover](#).

About this task

NOTE: Before removing the base cover, ensure that there is no SD card installed in the SD card slot on your computer.

NOTE: The I/O board includes a RJ45 network-port assembly. If you are replacing the I/O board, ensure that you remove the RJ45 network-port assembly from the old I/O board and install it in the new I/O board.

The following image(s) indicate the location of the I/O board and provides a visual representation of the removal procedure.



3x
M2x5



2x
M2x3

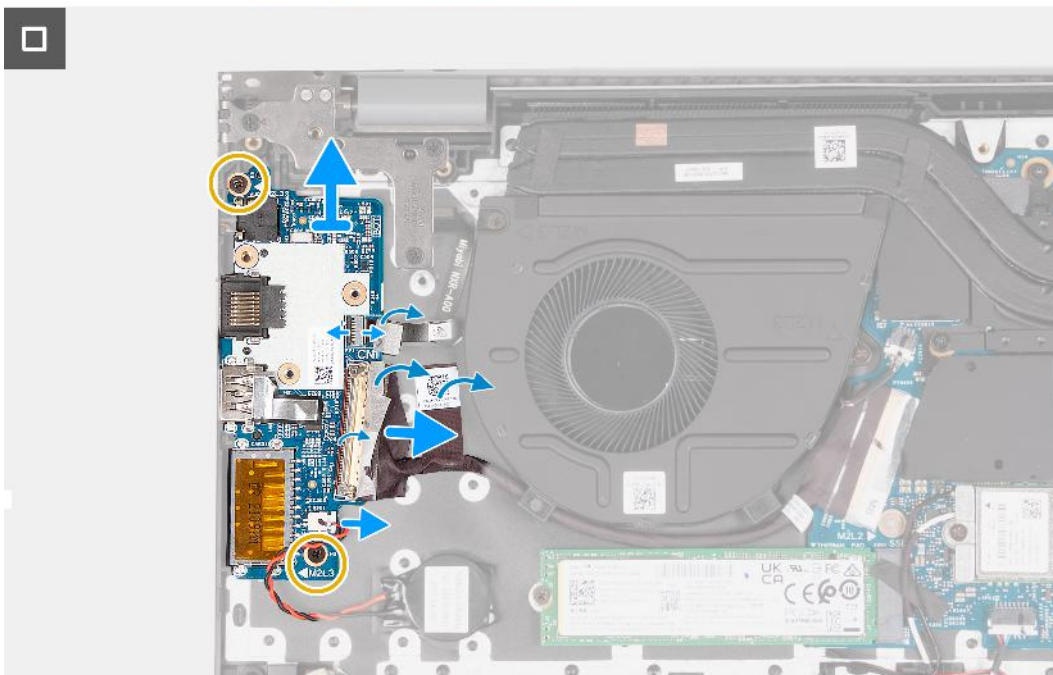
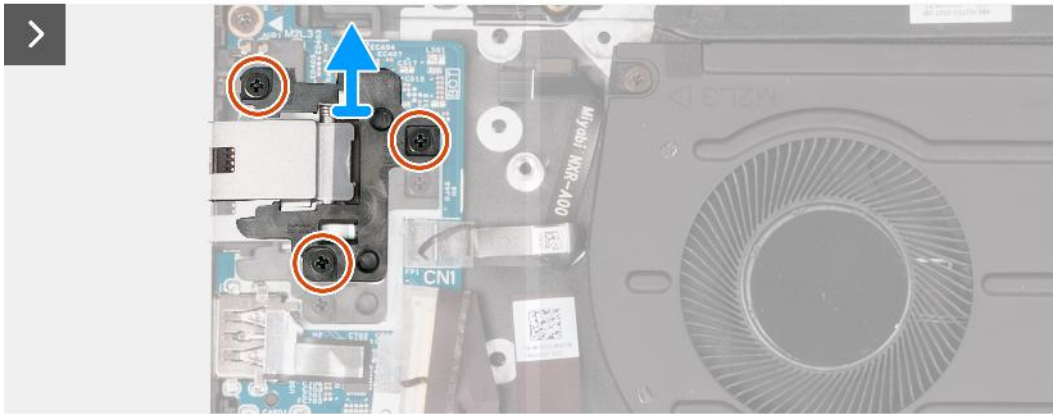
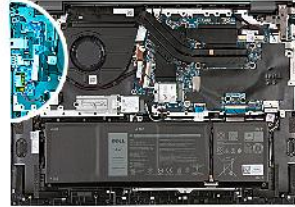

Steps

1. Remove the three screws (M2x5) that secure the RJ45 network-port assembly to the I/O board.
2. Lift the RJ45 network-port assembly off the I/O board.
3. Peel the tape that secures the I/O-board cable connector latch to the I/O board.
4. Open the latch and disconnect the power-button board cable from the I/O board.
5. Open the latch and disconnect the fingerprint-reader cable from the I/O board.

- Remove the two screws (M2x3) that secure the I/O board to the palm-rest and keyboard assembly.
- Lift the I/O board off the palm-rest and keyboard assembly.

Installing the I/O board

Prerequisites

CAUTION: The information in this section is intended for authorized service technicians only.

If you are replacing a component, remove the existing component before performing the installation process.

About this task

The following image(s) indicate the location of the I/O board and provides a visual representation of the installation procedure.

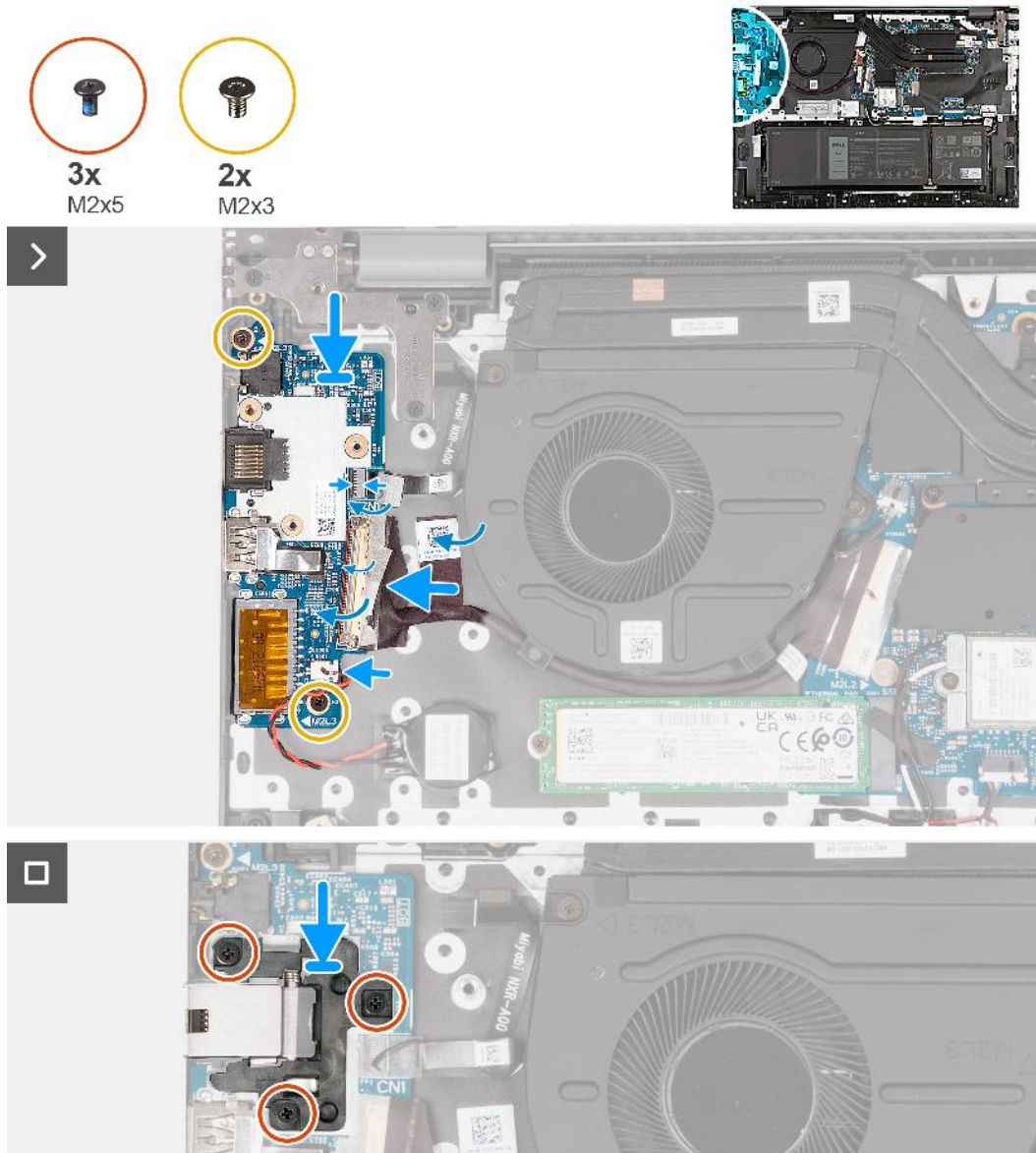

Steps

- Align the screw holes on the I/O board with the screw holes on the system board and palm-rest and keyboard assembly.
- Align the ports on the I/O board with the slots on the palm-rest and keyboard assembly.
- Place the I/O board on the palm-rest and keyboard assembly.

4. Replace the two screws (M2x3) that secure the I/O board to the palm-rest and keyboard assembly.
5. Connect the I/O-board cable to the I/O board.
6. Close the latch and replace the clear adhesive tape.
7. Connect the fingerprint-reader cable to the I/O board and close the latch to secure the cable.
8. Align the screw holes on the RJ45 network-port assembly with the screw holes of the I/O board.
9. Replace the three screws (M2x5) that secure the RJ45 network-port assembly to the I/O board.

Next steps

1. Install the [base cover](#).
2. Follow the procedure in [After working inside your computer](#).

Power button with optional fingerprint reader

Removing the power button with optional fingerprint reader

Prerequisites

CAUTION: The information in this section is intended for authorized service technicians only.

1. Follow the procedure in [Before working inside your computer](#).
2. Remove the [base cover](#).
3. Remove the [I/O board](#).

About this task

NOTE: Before removing the base cover, ensure that there is no SD card installed in the SD card slot on your computer.

The following image(s) indicate the location of the power button with optional fingerprint reader and provides a visual representation of the removal procedure.

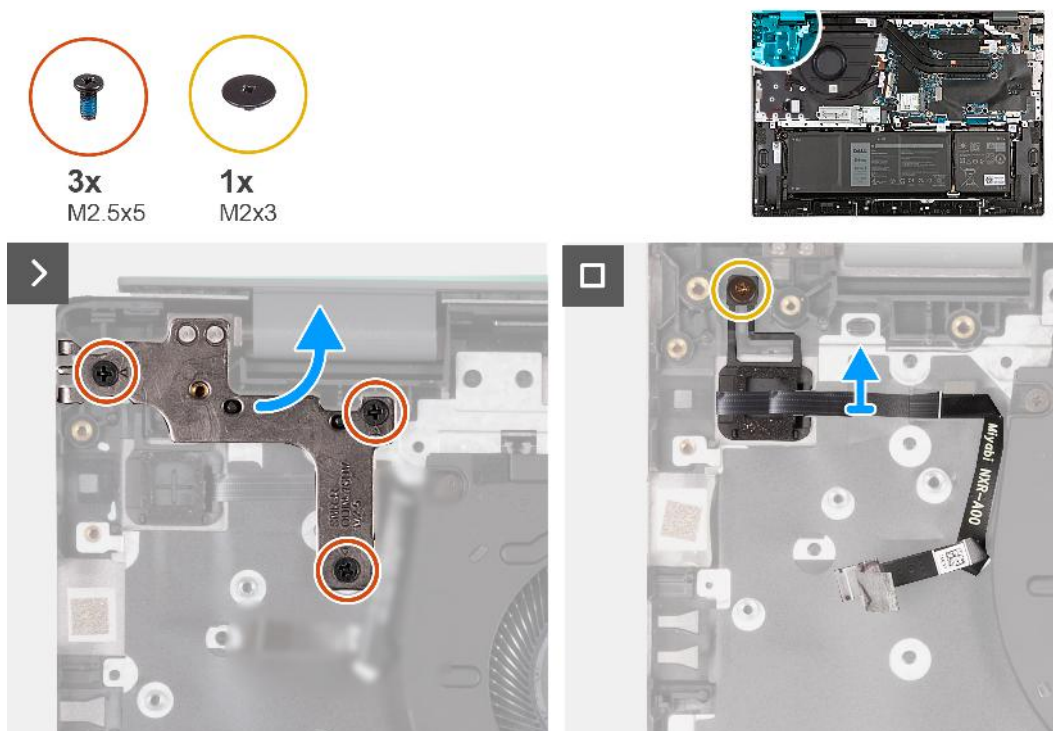

Steps

1. Remove the three screws (M2.5x5) that secure the left display hinge to the system board.
2. Open the left display hinge at an angle of 90 degrees.
3. Remove the screw (M2x3) that secures the power button with optional fingerprint reader with optional fingerprint reader to the palm-rest and keyboard assembly.
4. Lift the power button with optional fingerprint reader with optional fingerprint reader off the palm-rest and keyboard assembly.

Installing the power button with optional fingerprint reader

Prerequisites

CAUTION: The information in this section is intended for authorized service technicians only.

If you are replacing a component, remove the existing component before performing the installation process.

About this task

The following image(s) indicate the location of the power button with optional fingerprint reader and provides a visual representation of the installation procedure.

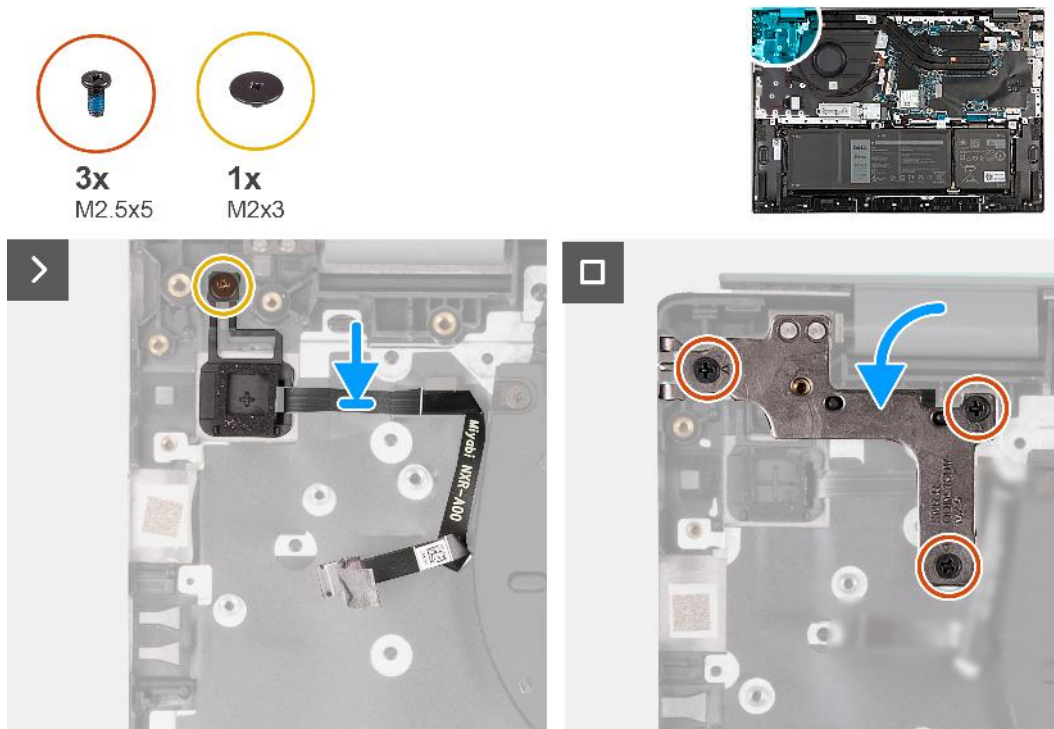

Steps

1. Place the power button with optional fingerprint reader with optional fingerprint reader on the palm-rest and keyboard assembly.
2. Align the screw hole on the power button with optional fingerprint reader with optional fingerprint reader with the screw hole on the palm-rest and keyboard assembly.
3. Replace the screw (M2x3) that secures the power button with optional fingerprint reader with optional fingerprint reader to the palm-rest and keyboard assembly.
4. Close the left display hinge and align the screw holes on the left display hinge with the screw holes on the palm-rest and keyboard assembly.
5. Replace the three screws (M2.5x5) that secure the left display hinge to the palm-rest and keyboard assembly.

Next steps

1. Install the [I/O board](#).
2. Install the [base cover](#).
3. Follow the procedure in [After working inside your computer](#).

Power-button module

Removing the power button

Prerequisites

 **CAUTION:** The information in this section is intended for authorized service technicians only.

1. Follow the procedure in [Before working inside your computer](#).
2. Remove the [base cover](#).
3. Remove the [I/O board](#).

About this task

 **NOTE:** Before removing the base cover, ensure that there is no SD card installed in the SD card slot on your computer.

The following image(s) indicate the location of the power button and provides a visual representation of the removal procedure.

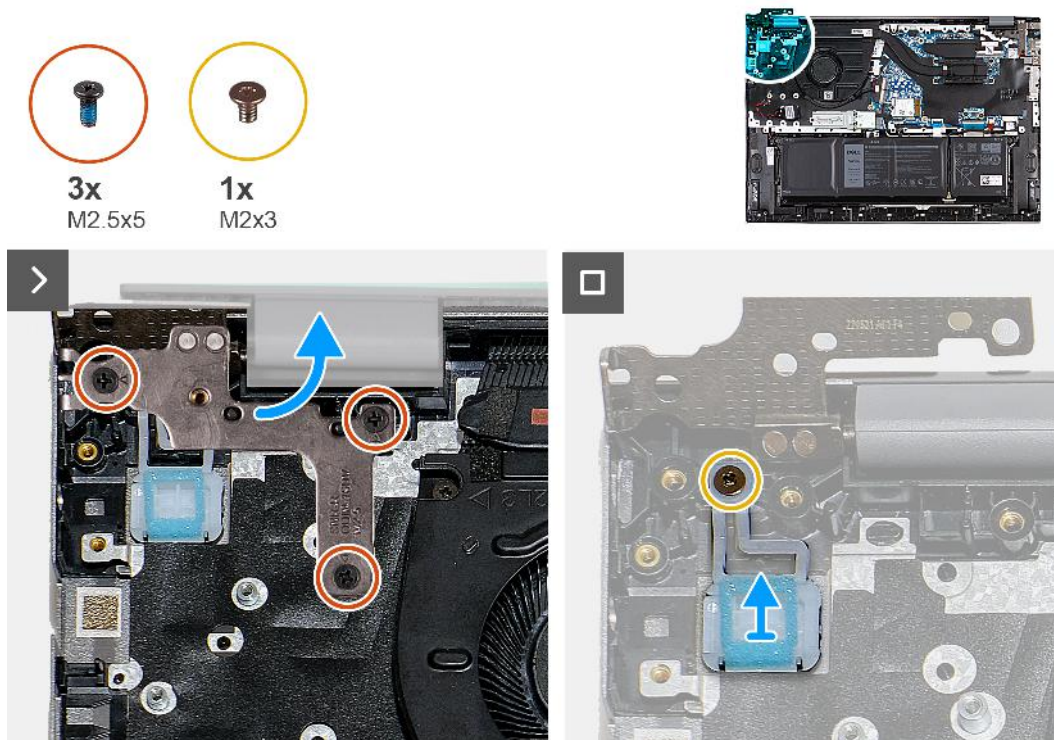

Steps

1. Remove the three screws (M2.5x5) that secure the left display hinge to the system board.
2. Open the left display hinge at an angle of 90 degrees.
3. Remove the screw (M2x3) that secures the power button to the palm-rest and keyboard assembly.
4. Lift the power button off the palm-rest and keyboard assembly.

Installing the power button

Prerequisites

CAUTION: The information in this section is intended for authorized service technicians only.

If you are replacing a component, remove the existing component before performing the installation process.

About this task

The following image(s) indicate the location of the power button and provides a visual representation of the installation procedure.

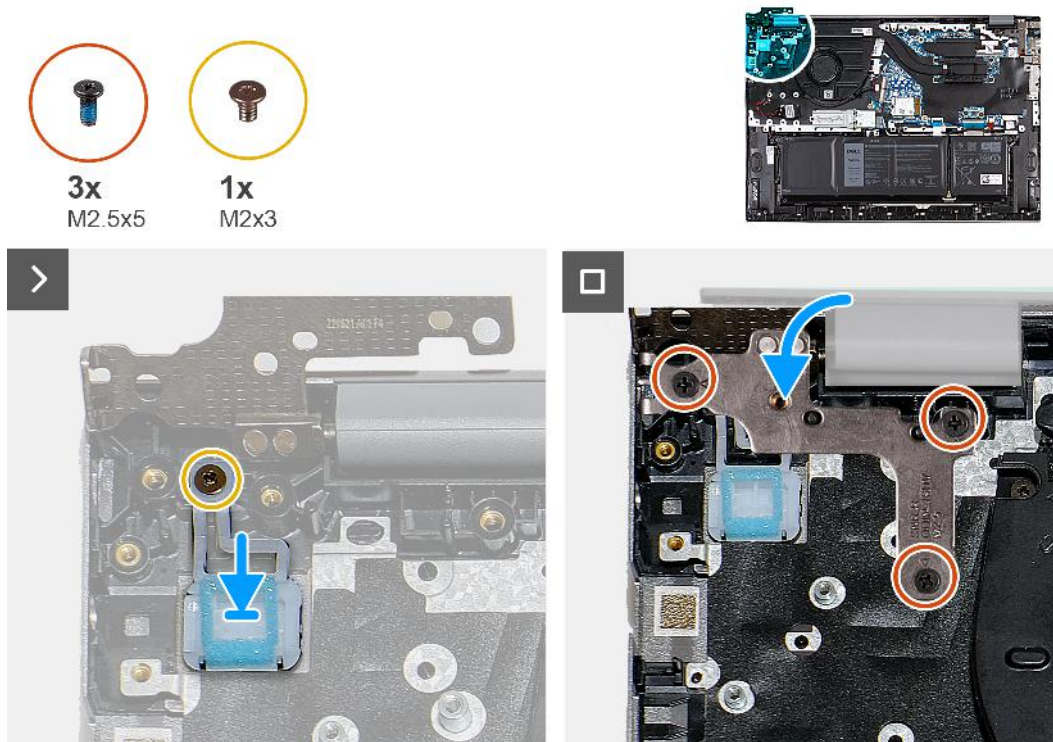

Steps

1. Place the power button on the palm-rest and keyboard assembly.
2. Align the screw hole on the power button with the screw hole on the palm-rest and keyboard assembly.
3. Replace the screw (M2x3) that secures the power button to the palm-rest and keyboard assembly.
4. Close the left display hinge and align the screw holes on the left display hinge with the screw holes on the palm-rest and keyboard assembly.
5. Replace the three screws (M2.5x5) that secure the left display hinge to the palm-rest and keyboard assembly.

Next steps

1. Install the [I/O board](#).
2. Install the [base cover](#).
3. Follow the procedure in [After working inside your computer](#).

Power-adapter port

Removing the power-adapter port

Prerequisites

CAUTION: The information in this section is intended for authorized service technicians only.

1. Follow the procedure in [Before working inside your computer](#).
2. Remove the [base cover](#).

About this task

NOTE: Before removing the base cover, ensure that there is no SD card installed in the SD card slot on your computer.

The following image(s) indicate the location of the power-adapter port and provides a visual representation of the removal procedure.

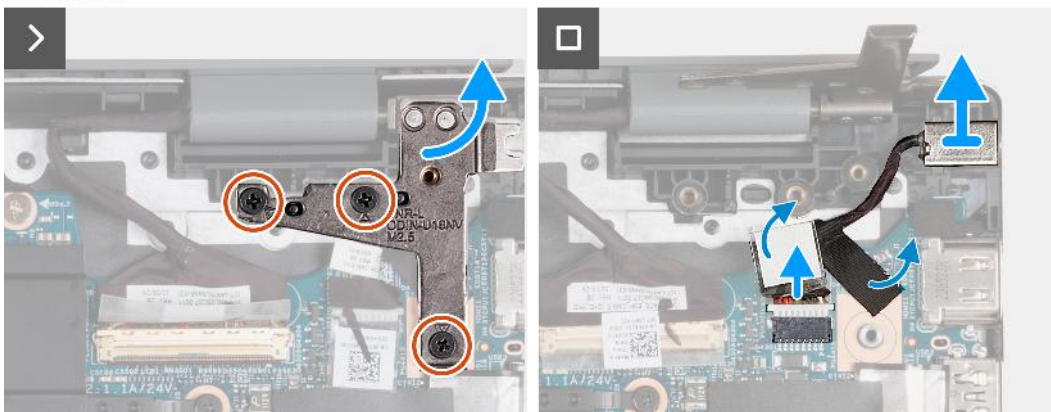

Steps

1. Remove the three screws (M2.5x5) that secure the right display hinge to the system board.
2. Open the right display hinge at an angle of 90 degrees.
3. Peel the tapes that secure the power-adapter port cable to the system board.
4. Disconnect the power-adapter port cable from the system board.
5. Lift the power-adapter port and its cable off the palm-rest and keyboard assembly.

Installing the power-adapter port

Prerequisites

CAUTION: The information in this section is intended for authorized service technicians only.

If you are replacing a component, remove the existing component before performing the installation process.

About this task

The following image(s) indicate the location of the power-adaptor port and provides a visual representation of the installation procedure.

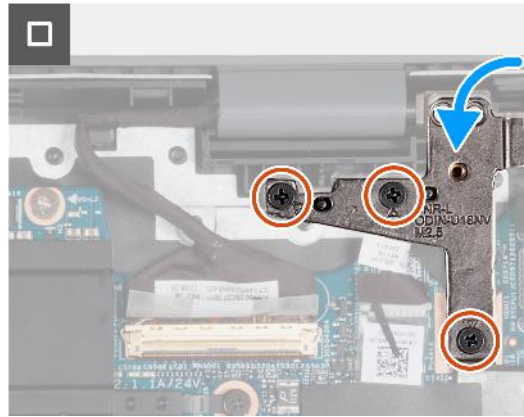
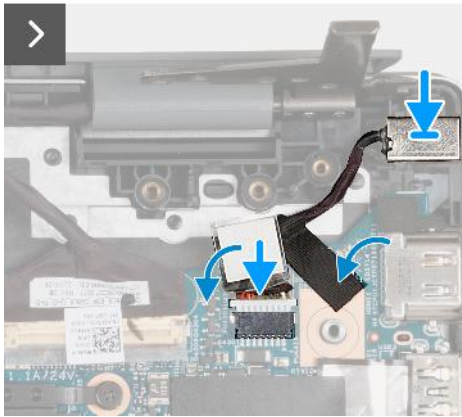
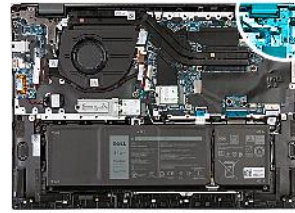

Steps

1. Place the power-adaptor port into the slot on the palm-rest and keyboard assembly.
2. Connect the power-adaptor port cable to the system board.
3. Adhere the tapes that secure the power-adaptor port cable to the system board.
4. Close the right display hinge and align the screw holes on the right display hinge with the screw holes on the system board.
5. Replace the three screws (M2.5x5) that secure the right display hinge to the system board.

Next steps

1. Install the [base cover](#).
2. Follow the procedure in [After working inside your computer](#).

Display assembly

Removing the display assembly

Prerequisites

CAUTION: The information in this section is intended for authorized service technicians only.

1. Follow the procedure in [Before working inside your computer](#).
2. Remove the [base cover](#).

About this task

NOTE: Before removing the base cover, ensure that there is no SD card installed in the SD card slot on your computer.

The following image(s) indicate the location of the display assembly and provides a visual representation of the removal procedure.



6x
M2.5x5

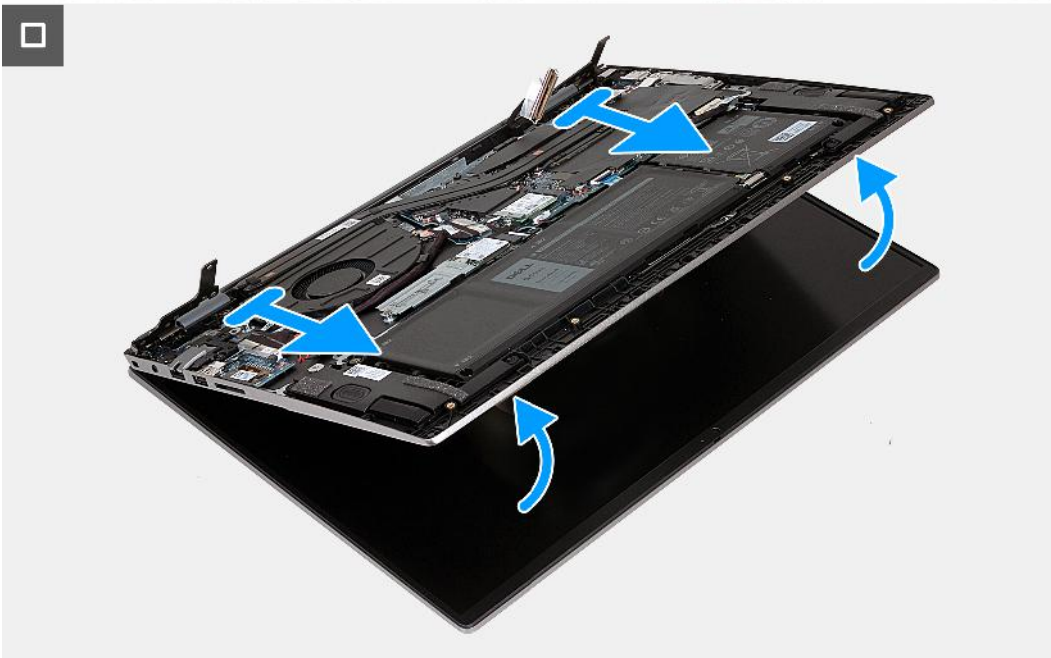
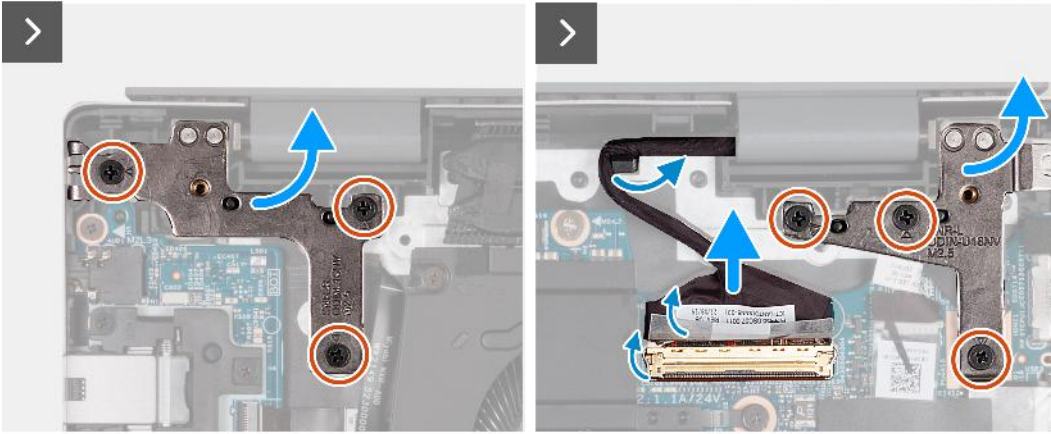
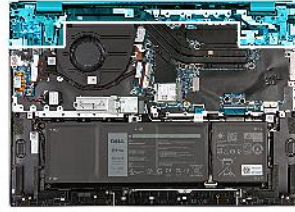

Steps

1. Remove the three screws (M2.5x5) that secure the left display hinge to the system board.
2. Open the left display hinge at an angle of 90 degrees.
3. Remove the three screws (M2.5x5) that secure the right display hinge to the system board.
4. Open the right display hinge at an angle of 90 degrees.
5. Peel the tape that secures the display-cable connector latch to the system board.
6. Open the latch and disconnect the display cable from the system board.
7. Remove the display cable from the routing guides on the palm-rest and keyboard assembly.
8. At an angle, gently lift the palm-rest and keyboard assembly off the display assembly.

Installing the display assembly

Prerequisites

CAUTION: The information in this section is intended for authorized service technicians only.

If you are replacing a component, remove the existing component before performing the installation process.

About this task

The following image(s) indicate the location of the display assembly and provides a visual representation of the installation procedure.



6x
M2.5x5

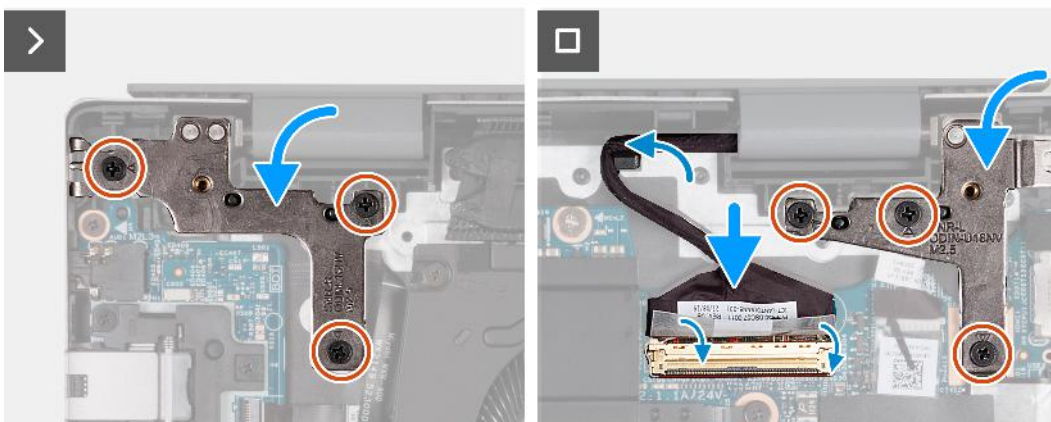
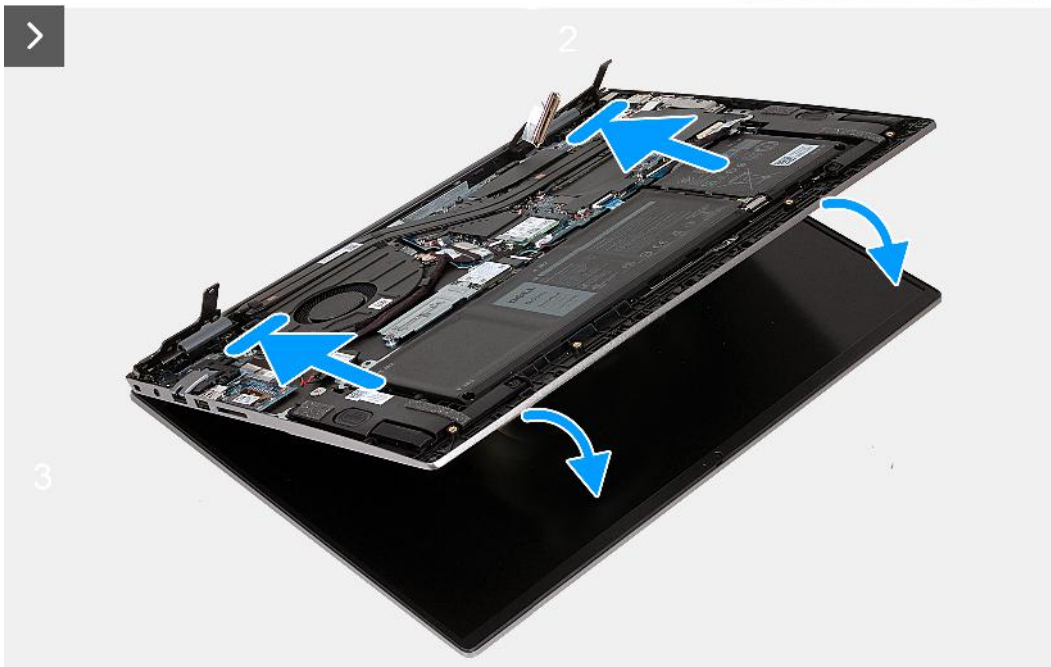
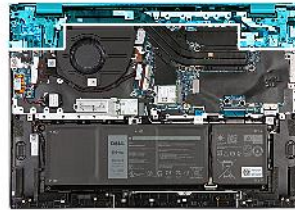

Steps

1. Place the display assembly on a clean and flat surface with the display panel facing up.

2. Gently place the palm-rest and keyboard assembly under the display hinges.
3. Close the left display hinge and align the screw holes on the left display hinge with the screw holes on the palm-rest and keyboard assembly.
4. Replace the three screws (M2.5x5) that secure the left display hinge to the palm-rest and keyboard assembly.
5. Close the right display hinge and align the screw holes on the right display hinge with the screw holes on the palm-rest and keyboard assembly.
6. Replace the three screws (M2.5x5) that secure the right display hinge to the palm-rest and keyboard assembly.
7. Route the display cable through the routing guides on the palm-rest and keyboard assembly.
8. Connect the display cable to the system board and close the latch.
9. Adhere the tape that secures the display-cable connector latch to the system board.

Next steps

1. Install the [base cover](#).
2. Follow the procedure in [After working inside your computer](#).

Trusted Platform Module

Removing the Trusted Platform Module (TPM) board

Prerequisites

CAUTION: The information in this section is intended for authorized service technicians only.

1. Follow the procedure in [Before working inside your computer](#).
2. Remove the [base cover](#).

About this task

NOTE: Before removing the base cover, ensure that there is no SD card installed in the SD card slot on your computer.

The following image(s) indicate the location of the tpm board and provides a visual representation of the removal procedure.



2x
M2x3.5

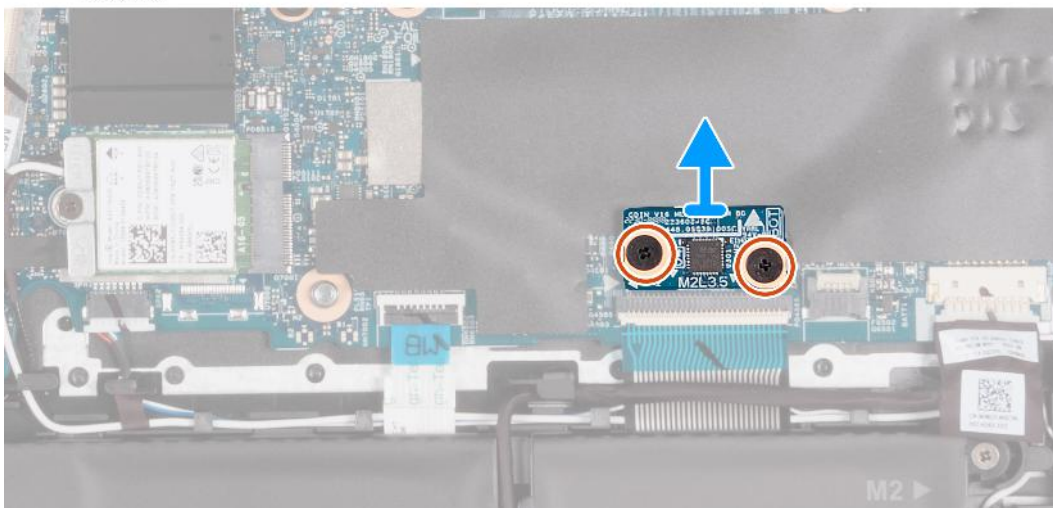
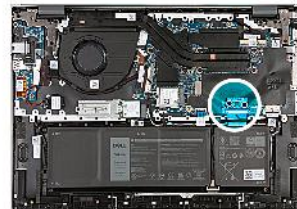

Steps

1. Remove the two screws (M2x3.5) that secure the TPM board to the system board.
2. Lift the TPM board off the system board.

Installing the Trusted Platform Module (TPM) board

Prerequisites

⚠ CAUTION: The information in this section is intended for authorized service technicians only.

If you are replacing a component, remove the existing component before performing the installation process.

About this task

The following image(s) indicate the location of the TPM board and provides a visual representation of the installation procedure.



2x
M2x3.5

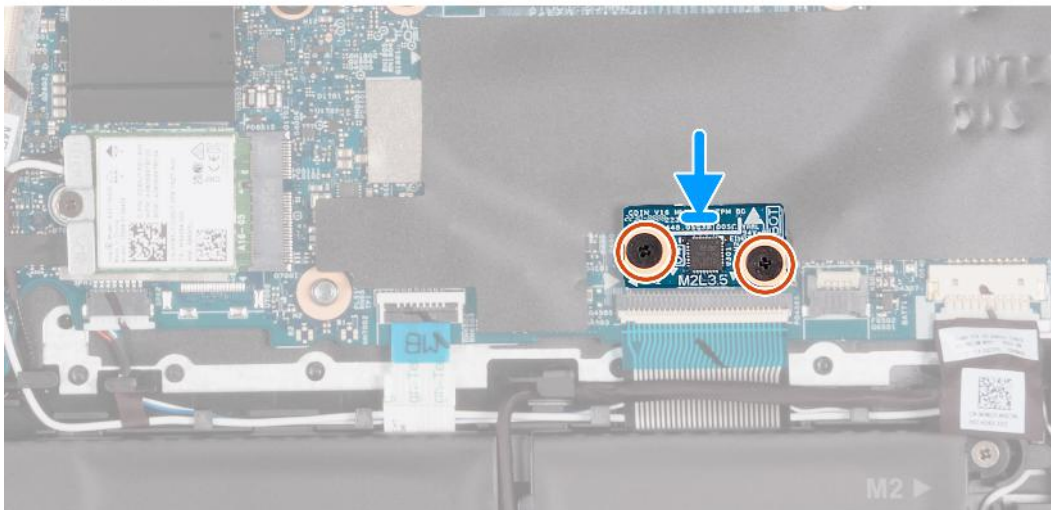

Steps

1. Align the screw holes on the TPM board with the screw holes on the system board.
2. Align the ports on the TPM board with the slots on the system board.
3. Place the TPM board on the system board.
4. Replace the two screws (M2x3) that secure the TPM board to the system board.

Next steps

1. Install the [base cover](#).
2. Follow the procedure in [After working inside your computer](#).

System board

Removing the system board

Prerequisites

1. Follow the procedure in [Before working inside your computer](#).
2. Remove the [base cover](#).
3. Remove the [M.2 2230 solid-state drive](#) or [M.2 2280 solid-state drive](#), whichever applicable.
4. Remove the [wireless card](#).
5. Remove the [heat sink](#).

About this task

- NOTE:** Before removing the base cover, ensure that there is no SD card installed in the SD card slot on your computer.
- NOTE:** The system board can be removed and installed along with the heat sink, when you replace the palm-rest and keyboard assembly. This simplifies the removal and installation procedure and also prevents damage to the thermal bond between the system board and heat sink.
- NOTE:** Device Encryption will be triggered when either the system board or storage (SSD) is replaced. Refer to [BitLocker](#) for more information on suspending BitLocker.

The following image(s) indicate the location of the system board and provides a visual representation of the removal procedure.

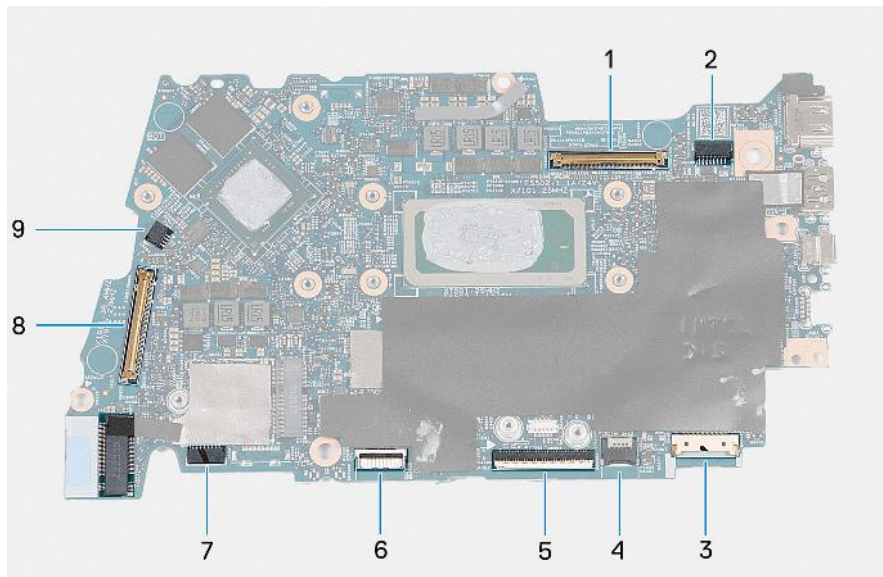

1. Display cable connector
2. Power-cable connector
3. Battery-cable connector
4. Keyboard-cable connector
5. Touchpad-cable connector
6. Keyboard-backlight cable connector
7. Speaker cable connector
8. I/O board-cable connector
9. Fan-cable connector



2x
M2x4



2x
M2x1.8



3x
M2.5x5

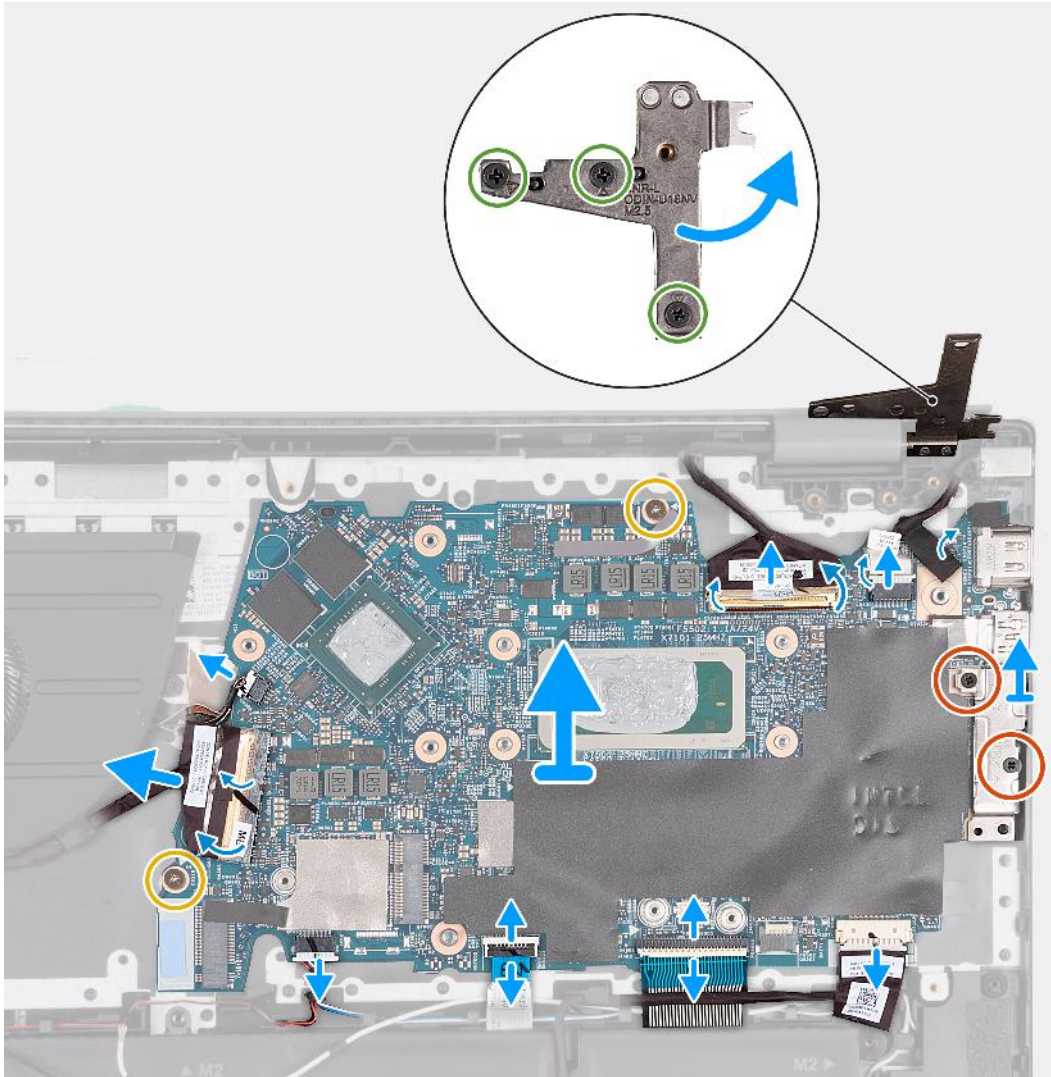
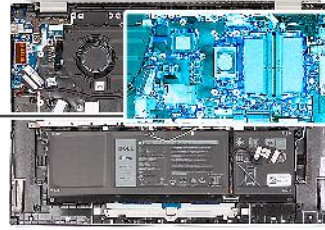

Steps

1. Remove the three screws (M2.5x5) that secure the right display hinge to the system board.
2. Open the right display hinge at an angle of 90 degrees.
3. Peel the tape that secures the display-cable connector latch to the system board.
4. Open the latch and disconnect the display cable from the system board.
5. Peel the tapes that secure the power-adapter port cable to the system board.
6. Disconnect the power-adapter port cable from the system board.
7. Remove the two screws (M2x4) that secure the Type-C port bracket to the system board.
8. Lift the Type-C port-bracket off the system board.
9. Disconnect the battery cable from the system board.
10. Open the latch and disconnect the keyboard cable from the system board.
11. Open the latch and disconnect the touchpad cable from the system board.
12. Disconnect the keyboard-backlight cable from the system board.

13. Open the latch and disconnect the I/O board cable from the system board
14. Disconnect the fan cable from the system board.
15. Remove the two screws (M2x1.8) that secure the system board to the palm-rest and keyboard assembly.
16. Lift the system board at angle off the palm-rest and keyboard assembly, to clear the ports from the port openings.

Installing the system board

Prerequisites

CAUTION: The information in this section is intended for authorized service technicians only.

If you are replacing a component, remove the existing component before performing the installation process.

About this task

The following image(s) indicate the location of the system board and provides a visual representation of the installation procedure.

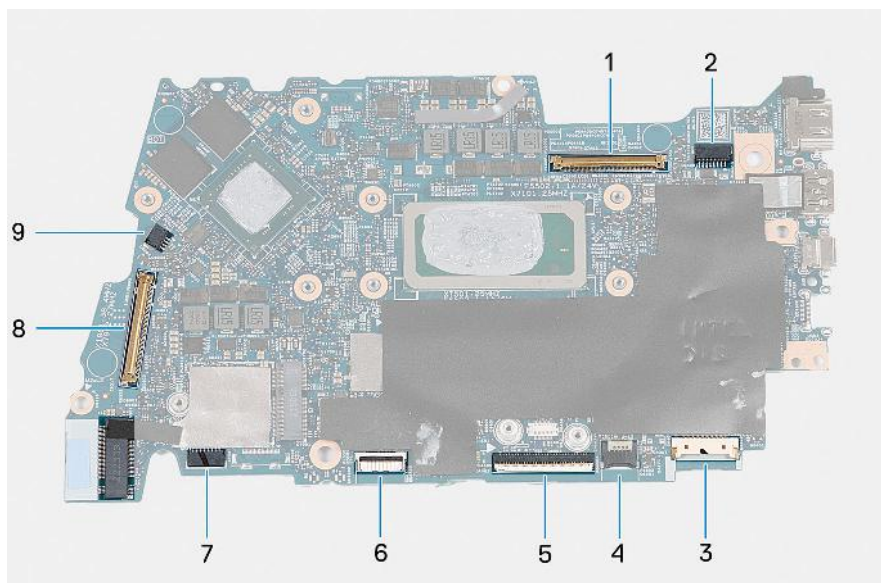

1. Display cable connector
2. Power-cable connector
3. Battery-cable connector
4. Keyboard-cable connector
5. Touchpad-cable connector
6. Keyboard-backlight cable connector
7. Speaker cable connector
8. I/O board-cable connector
9. Fan-cable connector

NOTE: The system board can be removed and installed along with the heat sink, when you replace the palm-rest and keyboard assembly. This simplifies the removal and installation procedure and also prevents damage to the thermal bond between the system board and heat sink.



2x
M2x4



2x
M2x1.8



3x
M2.5x5

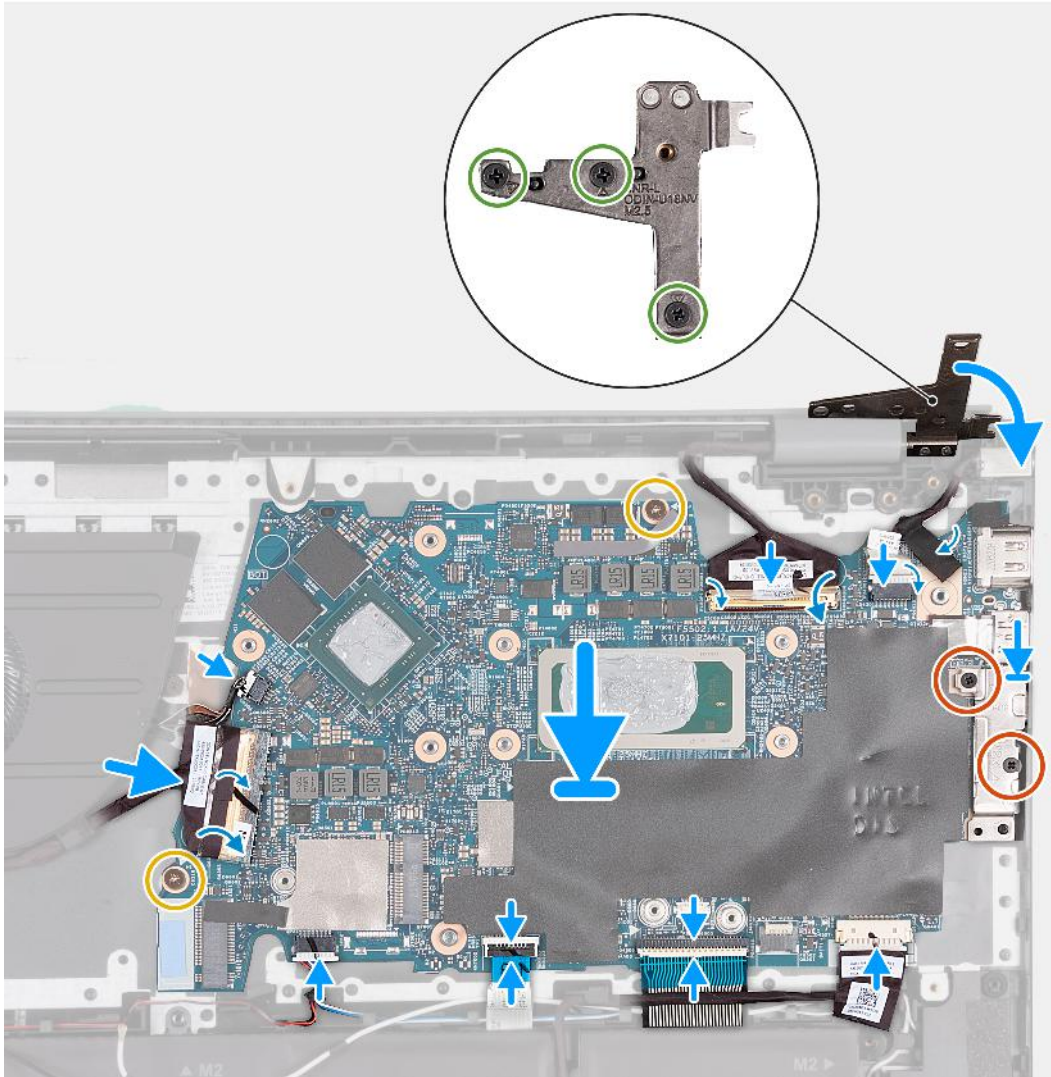
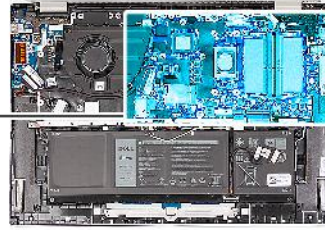

Steps

1. Install the system board at an angle and ensure that the ports are properly aligned with the port openings.
2. Place the system board on the palm-rest and keyboard assembly.
3. Align the screw holes on the system board with the screw holes on the palm-rest and keyboard assembly.
4. Replace the two screws (M2x1.8) that secure the system board to the palm-rest and keyboard assembly.
5. Connect the fan cable to the system board.
6. Connect the I/O board cable to the system board and close the latch.
7. Connect the keyboard-backlight cable to the system board.
8. Connect the touchpad cable to the system board and close the latch.
9. Connect the keyboard cable to the system board and close the latch.
10. Connect the battery cable to the system board.
11. Align the screw holes of the Type-C port-bracket with the screw holes of the system board.
12. Place the Type-C port-bracket on the system board.

13. Replace the two screws (M2x4) that secure the Type-C port-bracket to the system board.
14. Connect the power-adapter port cable to the system board.
15. Adhere the tapes that secure the power-adapter port cable to the system board.
16. Connect the display cable from the system board and close the latch.
17. Adhere the tape that secures the display-cable connector latch to the system board.
18. Connect the power-adapter port cable to the system board.
19. Adhere the tapes that secure the power-adapter port cable to the system board.
20. Connect the display cable to the system board and close the latch.
21. Adhere the tape that secures the display-cable connector latch to the system board.
22. Close the right display hinge and align the screw holes on the right display hinge with the screw holes on the palm-rest and keyboard assembly.
23. Replace the three screws (M2.5x5) that secure the right display hinge to the palm-rest and keyboard assembly.

Next steps

1. Install the [heat sink](#).
2. Install the [wireless card](#).
3. Install the [M.2 2230 solid-state drive](#) or [M.2 2280 solid-state drive](#), whichever applicable.
4. Install the [base cover](#).
5. Follow the procedure in [After working inside your computer](#).

Touchpad

Removing the touchpad

Prerequisites

 **CAUTION:** The information in this section is intended for authorized service technicians only.

1. Follow the procedure in [Before working inside your computer](#).
2. Remove the [base cover](#).
3. Remove the [battery](#).

About this task

 **NOTE:** Before removing the base cover, ensure that there is no SD card installed in the SD card slot on your computer.

The following image(s) indicate the location of the touchpad and provides a visual representation of the removal procedure.

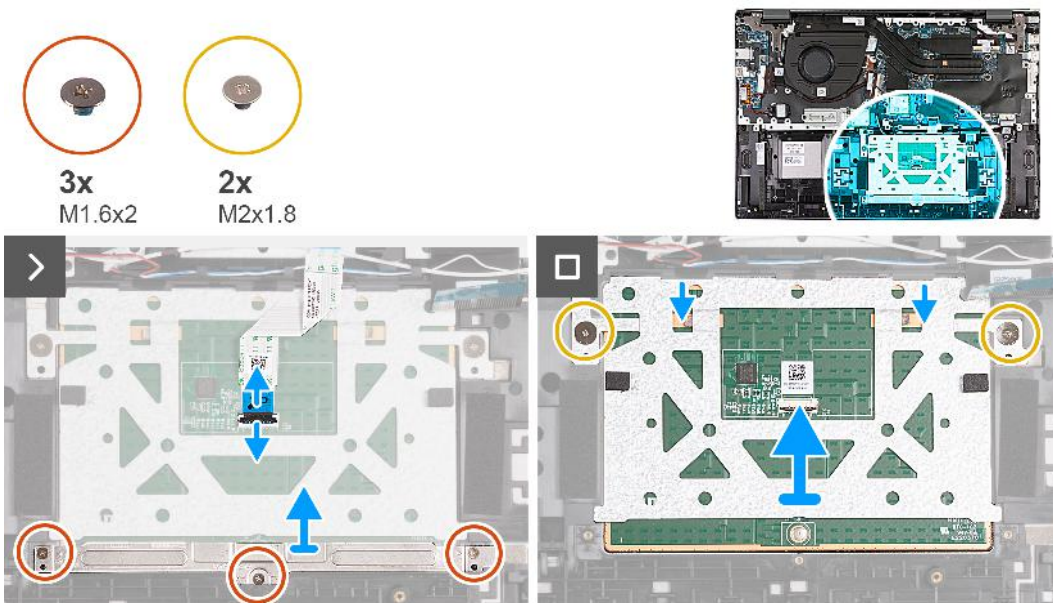

Steps

1. Open the latch of the touchpad connector and disconnect the touchpad cable from the touchpad.
2. Remove the three screws (M1.6x2) that secure the touchpad bracket to the palm-rest and keyboard assembly.
3. Lift the touchpad bracket off the palm-rest and keyboard assembly.
4. Remove the two screws (M2x1.8) that secure the touchpad to the palm-rest and keyboard assembly.
5. Lift the touchpad assembly off the palm-rest and keyboard assembly.

Installing the touchpad

Prerequisites

If you are replacing a component, remove the existing component before performing the installation process.

About this task

The following image(s) indicate the location of the touchpad and provides a visual representation of the installation procedure.

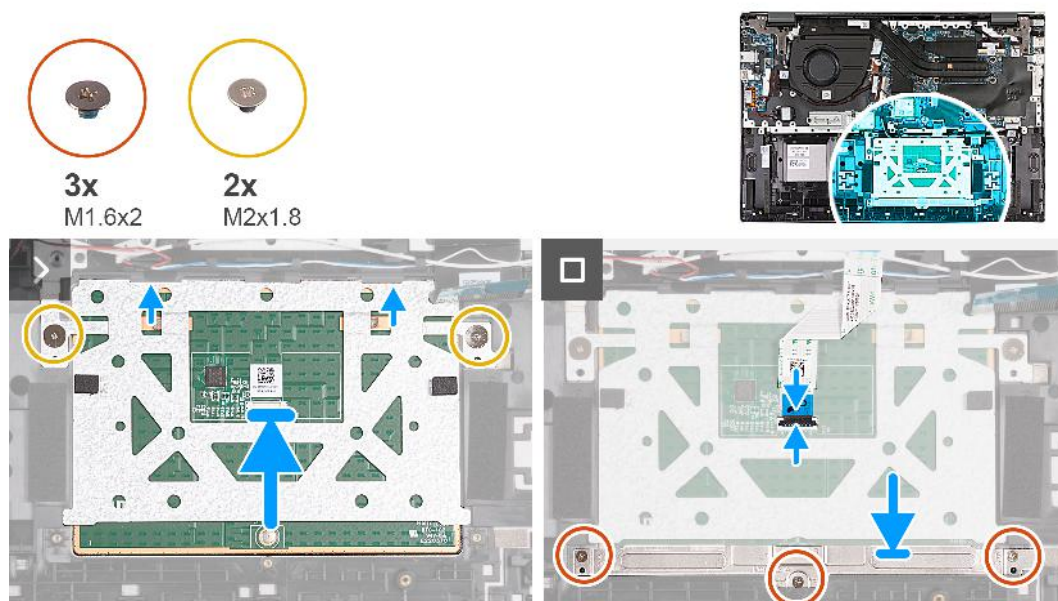

Steps

1. Slide the touchpad onto the palm-rest and keyboard assembly.
2. Replace the two screws (M2x1.8) that secure the touchpad to the palm-rest and keyboard assembly.
3. Align the touchpad bracket and place it on the palm-rest and keyboard assembly.
4. Replace the three screws (M1.6x2) that secure the touchpad bracket to the palm-rest and keyboard assembly.
5. Connect the touchpad cable to the touchpad and close the latch.

Next steps

1. Install the [battery](#).
2. Install the [base cover](#).
3. Follow the procedure in [After working inside your computer](#).

Palm-rest and keyboard assembly

Removing the palm-rest and keyboard assembly

Prerequisites

 **CAUTION:** The information in this section is intended for authorized service technicians only.

1. Follow the procedure in [Before working inside your computer](#).
2. Remove the [base cover](#).
3. Remove the [fan](#).
4. Remove the [wireless card](#).
5. Remove the [M.2 2230 solid-state drive](#) or [M.2 2280 solid-state drive](#), whichever applicable.
6. Remove the [battery](#).
7. Remove the [speakers](#).
8. Remove the [coin-cell battery](#).
9. Remove the [I/O board](#).
10. Remove the [power button with optional fingerprint reader](#) or [power button](#), whichever applicable.
11. Remove the [power-adaptor port](#).
12. Remove the [display assembly](#).
13. Remove the [TPM board](#).
14. Remove the [system board](#).
15. Remove the [touchpad](#).

About this task

 **NOTE:** Before removing the base cover, ensure that there is no SD card installed in the SD card slot on your computer.

 **NOTE:** The system board can be removed and installed along with the heat sink, when you replace the palm-rest and keyboard assembly. This simplifies the removal and installation procedure and also prevents damage to the thermal bond between the system board and heat sink.

The following image(s) indicate the location of the palm-rest and keyboard assembly and provides a visual representation of the removal procedure.

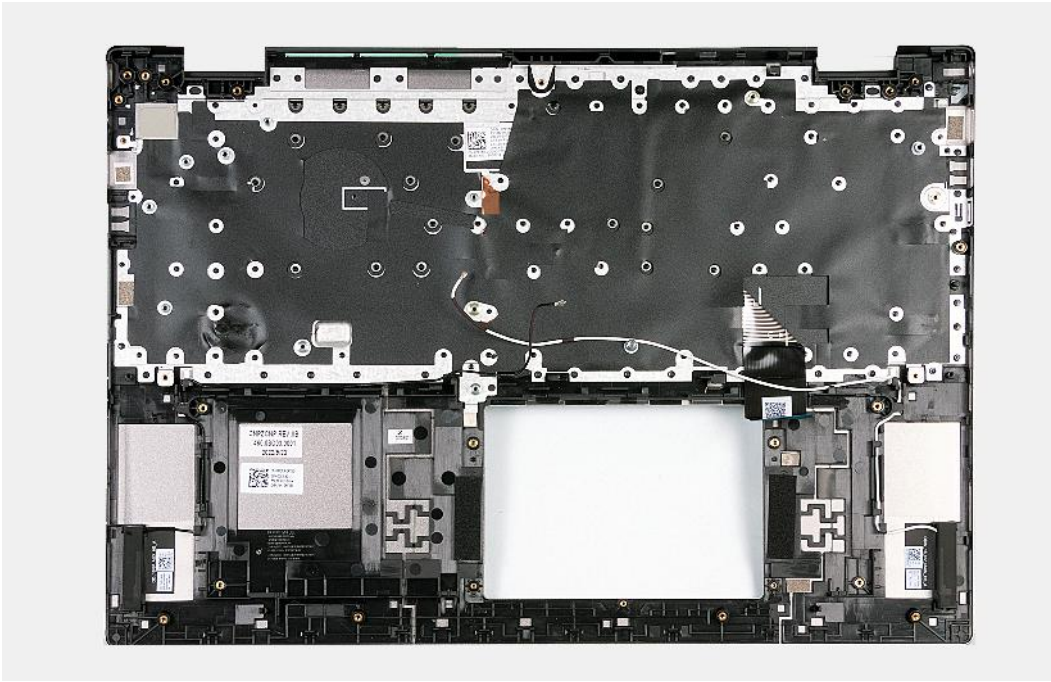

Steps

After performing the pre-requisites, you are left with the palm-rest and keyboard assembly.

Installing the palm-rest and keyboard assembly

Prerequisites

CAUTION: The information in this section is intended for authorized service technicians only.

If you are replacing a component, remove the existing component before performing the installation process.

About this task

The following image(s) indicate the location of the palm-rest and keyboard assembly and provides a visual representation of the installation procedure.

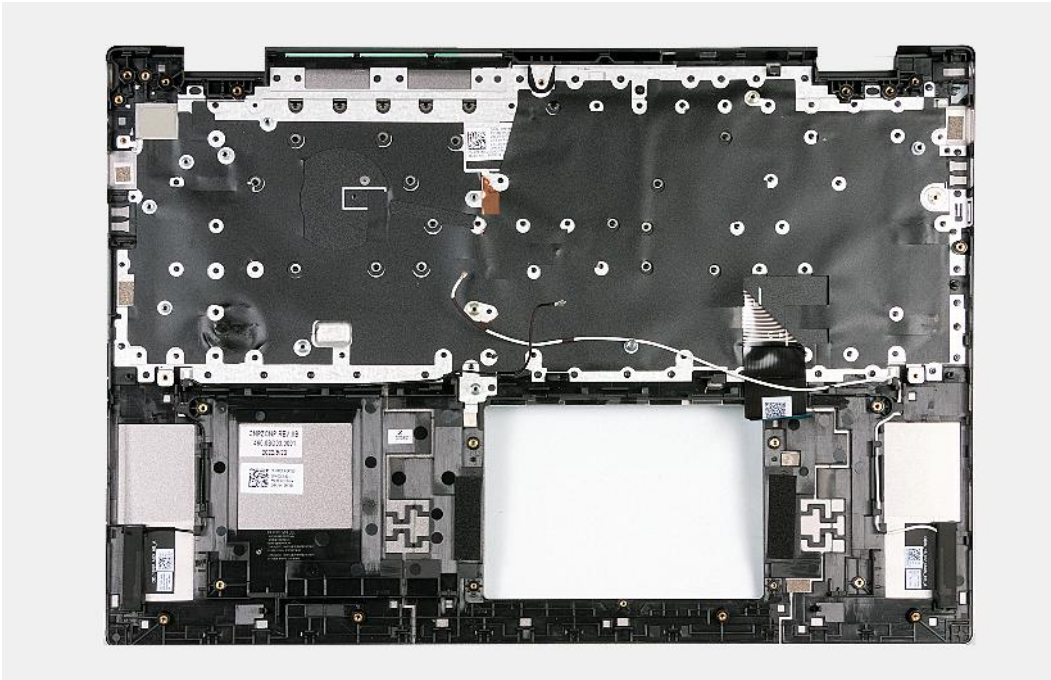

Steps

Place the palm-rest and keyboard assembly on a flat and clean surface and perform the post-requisites to install the palm-rest and keyboard assembly.

Next steps

NOTE: The system board can be removed and installed along with the heat sink, when you replace the palm-rest and keyboard assembly. This simplifies the removal and installation procedure and also prevents damage to the thermal bond between the system board and heat sink.

1. Install the [touchpad](#).
2. Install the [system board](#).
3. Install the [tpm board](#).
4. Install the [display assembly](#).
5. Install the [power adapter port](#)
6. Install the [power button with optional fingerprint reader](#) or [power button](#), whichever applicable.
7. Install the [I/O board](#).
8. Install the [coin-cell battery](#).
9. Install the [speakers](#).
10. Install the [battery](#).
11. Install the [M.2 2230 solid-state drive](#) or [M.2 2280 solid-state drive](#), whichever applicable.
12. Install the [wireless card](#).
13. Install the [fan](#).
14. Install the [base cover](#).
15. Follow the procedure in [After working inside your computer](#).

Software

This chapter details the supported operating systems along with instructions on how to install the drivers.

Operating system

Your Vostro 16 5635 supports the following operating systems:

- Windows 11 Pro, 64-bit
- Windows 11 Home, 64-bit
- Windows 10 Pro, 64-bit
- Windows 10 Home, 64-bit

Drivers and downloads

When troubleshooting, downloading or installing drivers it is recommended that you read the Dell Knowledge Based article, Drivers and Downloads FAQ [000123347](#).

BIOS setup

CAUTION: Unless you are an expert computer user, do not change the settings in the BIOS Setup program. Certain changes can make your computer work incorrectly.

NOTE: Depending on the computer and its installed devices, the items listed in this section may or may not be displayed.

NOTE: Before you change BIOS Setup program, it is recommended that you write down the BIOS Setup program screen information for future reference.

Use the BIOS Setup program for the following purposes:

- Get information about the hardware installed in your computer, such as the amount of RAM and the size of the hard drive.
- Change the system configuration information.
- Set or change a user-selectable option, such as the user password, type of hard drive installed, and enabling or disabling base devices.

Entering BIOS setup program

About this task

Turn on (or restart) your computer and press F2 immediately.

Navigation keys

NOTE: For most of the System Setup options, changes that you make are recorded but do not take effect until you restart the system.

Table 28. Navigation keys

Keys	Navigation
Up arrow	Moves to the previous field.
Down arrow	Moves to the next field.
Enter	Selects a value in the selected field (if applicable) or follow the link in the field.
Spacebar	Expands or collapses a drop-down list, if applicable.
Tab	Moves to the next focus area. NOTE: For the standard graphics browser only.
Esc	Moves to the previous page until you view the main screen. Pressing Esc in the main screen displays a message that prompts you to save any unsaved changes and restarts the system.

One time boot menu

To enter **one time boot menu**, turn on your computer, and then press F2 immediately.

NOTE: It is recommended to shutdown the computer if it is on.

The one-time boot menu displays the devices that you can boot from including the diagnostic option. The boot menu options are:

- Removable Drive (if available)
- STXXXX Drive (if available)
- **i** **NOTE:** XXX denotes the SATA drive number.
- Optical Drive (if available)
- SATA Hard Drive (if available)
- Diagnostics
- **i** **NOTE:** Choosing **Diagnostics**, will display the **ePSA diagnostics** screen.

The boot sequence screen also displays the option to access the System Setup screen.

One time boot menu

To enter **one time boot menu**, turn on your computer, and then press F12 immediately.

i **NOTE:** It is recommended to shutdown the computer if it is on.

The one-time boot menu displays the devices that you can boot from including the diagnostic option. The boot menu options are:

- Removable Drive (if available)
- STXXXX Drive (if available)
- **i** **NOTE:** XXX denotes the SATA drive number.
- Optical Drive (if available)
- SATA Hard Drive (if available)
- Diagnostics

The boot sequence screen also displays the option to access the System Setup screen.

System setup options

i **NOTE:** Depending on your system and its installed devices, the items that are listed in this section may or may not appear.

Table 29. System setup options—System information menu

Overview	
Lattitude 3320	
BIOS Version	Displays the BIOS version number.
Service Tag	Displays the Service Tag of the system.
Asset Tag	Displays the Asset Tag of the system.
Manufacture Date	Displays the manufacture date of the system.
Ownership Date	Displays the ownership date of the system.
Express Service Code	Displays the express service code of the system.
Ownership Tag	Displays the Ownership Tag of the system.
Signed Firmware Update	Displays whether the Signed Firmware Update is enabled on your system.
Battery Information	
Primary	Displays that battery is primary.
Battery Level	Displays the battery level of the system.
Battery State	Displays the battery state of the system.
Health	Displays the battery health of the system.

Table 29. System setup options—System information menu (continued)

Overview	
AC Adapter	Displays whether the AC adapter is connected or not.
Processor Information	
Processor Type	Displays the processor type.
Maximum Clock Speed	Displays the maximum processor clock speed.
Minimum Clock Speed	Displays the minimum processor clock speed.
Current Clock Speed	Displays the current processor clock speed.
Core Count	Displays the number of cores on the processor.
Processor ID	Displays the processor identification code.
Processor L2 Cache	Displays the processor L2 Cache size.
Processor L3 Cache	Displays the processor L3 Cache size.
Microcode Version	Displays the microcode version.
Intel Hyper-Threading Capable	Displays whether the processor is Hyper-Threading (HT) capable.
64-Bit Technology	Displays whether 64-bit technology is used.
Memory Information	
Memory Installed	Displays the total system memory installed.
Memory Available	Displays the total system memory available.
Memory Speed	Displays the memory speed.
Memory Channel Mode	Displays single or dual channel mode.
Memory Technology	Displays the technology that is used for the memory.
Devices Information	
Panel Type	Displays the Panel Type of the system.
Video Controller	Displays the video controller type of the system.
Video Memory	Displays the video memory information of the system.
Wi-Fi Device	Displays the wireless device information of the system.
Native Resolution	Displays the native resolution of the system.
Video BIOS Version	Displays the video BIOS version of the system.
Audio Controller	Displays the audio controller information of the system.
Bluetooth Device	Displays the Bluetooth device information of the system.

Table 30. System setup options—Boot Configuration menu

Boot Configuration	
Boot Sequence	
Boot mode	Displays the boot mode.
Boot Sequence	Displays the boot sequence.
Secure Digital (SD) Card Boot	Enable or disable the SD card read-only boot. By default, the Secure Digital (SD) Card Boot option is not enabled.
Secure Boot	
Enable Secure Boot	Enable or disable the secure boot feature. By default, the option is not enabled.
Secure Boot Mode	Enable or disable to change the secure boot mode options.

Table 30. System setup options—Boot Configuration menu (continued)

Boot Configuration	
	By default, the Deployed Mode is enabled.
Expert Key Management	
Enable Custom Mode	Enable or disable custom mode. By default, the custom mode option is not enabled.
Custom Mode Key Management	Select the custom values for expert key management.

Table 31. System setup options—Integrated Devices menu

Integrated Devices	
Date/Time	Displays the current date in MM/DD/YYYY format and current time in HH:MM:SS AM/PM format.
Camera	Enables or disable the camera. By default, the Enable Camera option is selected
Audio	
Enable Audio	Enable or disable the integrated audio controller. By default, all the options are enabled.
USB Configuration	<ul style="list-style-type: none"> • Enable or disable booting from USB mass storage devices that are connected to external USB ports. By default, the Enable External USB Ports option is enabled. • Enable or disable booting from USB mass storage devices such as external hard drive, optical drive, and USB drive. By default, the Enable USB Boot Support option is enabled.
Disable USB4 PCIE Tunneling	Disable the USB4 PCIE Tunneling option. By default, the option is disabled.
Video/Power only on Type-C Ports	Enable or disable the Type-C port functionality to video or power only. By default, the Video/Power only on Type-C Ports option is disabled.

Table 32. System setup options—Storage menu

Storage	
SATA/NVMe Operation	
SATA/NVMe Operation	Set the operating mode of the integrated storage device controller. By default, the RAID On option is enabled.
Storage interface	
Port Enablement	This page allows you to enable the onboard drives. By default, the M.2 PCIe SSD option is enabled.
SMART Reporting	
Enable SMART Reporting	Enable or disable Self-Monitoring, Analysis, and Reporting Technology (SMART) during system startup. By default, the Enable SMART Reporting option is not enabled.
Drive Information	
M.2 PCIe SSD	

Table 32. System setup options—Storage menu (continued)

Storage	
Type	Displays the M.2 PCIe SSD type information of the system.
Device	Displays the M.2 PCIe SSD device information of the system.
Enable MediaCard	
Secure Digital (SD) Card	Enable or disable the SD card. By default, the Secure Digital (SD) Card option is enabled.
Secure Digital (SD) Card Read-Only Mode	Enable or disable the SD card read-only mode. By default, the Secure Digital (SD) Card Read-Only Mode option is not enabled.

Table 33. System setup options—Display menu

Display	
Display Brightness	
Brightness on battery power	Enable to set screen brightness when the system is running on battery power.
Brightness on AC power	Enable to set screen brightness when the system is running on AC power.
EcoPower	
	Enable or disable EcoPower Feature in your panel. EcoPower can increase the battery life of your system by reducing the display brightness when appropriate. By default, Enable EcoPower option is enabled.
Full Screen Logo	
	Enable or disable full screen logo. By default, the option is not enabled.

Table 34. System setup options—Connection menu

Connection	
Wireless Device Enable	
WLAN	Enable or disable the internal WLAN device. By default, the option enabled.
Bluetooth	Enable or disable the internal Bluetooth device By default, the option enabled.
Enable UEFI Network Stack	
	Enable or disable UEFI Network Stack and controls the on-board LAN Controller. By default, the Enable UEFI Network Stack option is enabled.
HTTPs Boot Feature	
HTTPs Boot	Enable or disable the HTTPs Boot feature. By default, the HTTPs Boot option is disabled.

Table 35. System setup options—Power menu

Power	
Battery configuration	
	Enables the system to run on battery during peak power usage hours. Use the table Custom Charge Start and Custom Charge Stop , to prevent AC power usage between certain times of each day. By default, the Adaptive option is enabled.
Advanced Configuration	

Table 35. System setup options—Power menu (continued)

Power	
Enable Advanced Battery Charge Configuration	<p>Enable or disable the advanced battery charge configuration.</p> <p>By default, the Enable Advanced Battery Charge Configuration option is disabled.</p>
<p>Peak Shift</p> <p>Enable Peak Shift</p>	<p>Enables the system to run on battery during peak power usage hours.</p> <p>By default, the Enable Peak Shift option is disabled.</p>
<p>Thermal Management</p>	<p>Enables to cool the fan and processor heat management to adjust the system performance, noise, and temperature.</p> <p>By default, the Optimized option is enabled.</p>
<p>USB Wake Support</p> <p>Enable USB Wake Support</p>	<p>When enabled, the USB devices like a mouse or keyboard can be used to wake the system from Standby, Hibernate, and Power Off.</p> <p>NOTE: This feature requires Deep Sleep Control to be disabled.</p> <p>NOTE: This feature is only functional when the AC power adapter is connected. If the AC power adapter is removed before Standby, the BIOS will remove power from all of the USB ports to conserve battery power.</p> <p>By default, the Enable USB Wake Support option is disabled.</p>
Wake on Dell USB-C Dock	<p>When enabled, connecting a Dell USB-C Dock will wake the system from Standby, Hibernate, and Power Off.</p> <p>By default, the Wake on Dell USB-C Dock option is enabled.</p>
<p>Block Sleep</p>	<p>Enables to block entering sleep (S3) mode in the operating system.</p> <p>By default, the Block Sleep option is disabled.</p>
<p>Lid Switch</p> <p>Enabled Lid Switch</p>	<p>Enable or disable the lid switch.</p> <p>By default, the Enable Lid Switch option is enabled.</p>
Power On Lid Open	<p>When enabled, allows the system to power up from the off state whenever the lid is opened.</p> <p>By default, the Power On Lid Open option is enabled.</p>
<p>Intel Speed Shift Technology</p>	<p>Enable or disable the Intel speed shift technology support.</p> <p>By default, the Intel Speed Shift Technology option is enabled.</p>

Table 36. System setup options—Security menu

Security	
<p>TPM 2.0 Security</p> <p>TPM 2.0 Security On</p>	<p>Allows you to enable or disable TPM visibility to operating system.</p> <p>By default, the TPM 2.0 Security On option is enabled.</p>
Attestation Enable	<p>Enables to control whether the Trusted Platform Module (TPM) Endorsement Hierarchy is available to the operating system.</p> <p>By default, the Attestation Enable option is enabled.</p>
Key Storage Enable	<p>Enables to control whether the Trusted Platform Module (TPM) Storage Hierarchy is available to the operating system.</p> <p>By default, the Key Storage Enable option is enabled.</p>

Table 36. System setup options—Security menu (continued)

Security	
SHA-256	<p>When enabled, the BIOS and TPM will use the SHA-256 hash algorithm to extend measurements into the TPM PCRs during BIOS boot.</p> <p>By default, the SHA-256 option is enabled.</p>
Clear	<p>Enables to clear the TPM owner information and returns the TPM to the default state.</p> <p>By default, the Clear option is disabled.</p>
PPI Bypass for Clear Commands	<p>Controls the TPM Physical Presence Interface (PPI).</p> <p>By default, the PPI ByPass for clear Commands option is disabled.</p>
SMM Security Mitigation	<p>Enable or disable additional UEFI SMM Security Mitigation protections.</p> <p>By default, the option is enabled.</p>
Data Wipe on Next Boot	
Start Data Wipe	<p>Enable or disable the data wipe on next boot.</p> <p>By default, the Start Data Wipe option is disabled.</p>
Absolute	<p>Enable or disable or permanently disable the BIOS module interface of the optional Absolute Persistence Module service from Absolute software.</p> <p>By default, the option is enabled.</p> <p>⚠ WARNING: The 'Permanently Disabled' option can only be selected once. When 'Permanently Disabled' is selected, Absolute Persistence cannot be re-enabled. No further changes to the Enable/Disable states are allowed.</p> <p>i NOTE: The Enable/Disable options will be unavailable while Computrace is in the activated state.</p>
UEFI Boot Path Security	<p>Controls whether the system will prompt the user to enter the admin password (if set) when booting to a UEFI boot path device from the F12 boot menu.</p> <p>By default, the Always Except Internal HDD option is enabled.</p>

Table 37. System setup options—Passwords menu

Passwords	
Admin Password	Set, change, or delete the administrator password.
System Password	Set, change, or delete the system password.
NVMe SSD0	Set, change, or delete the NVMe SSD0 password.
Password Configuration	
Upper Case Letter	<p>Reinforces password must have at least one upper case letter.</p> <p>By default, the option is disabled.</p>
Lower Case Letter	<p>Reinforces password must have at least one lower case letter.</p> <p>By default, the option is disabled.</p>
Digit	<p>Reinforces password must have at least one digit number.</p> <p>By default, the option is disabled.</p>
Special Character	<p>Reinforces password must have at least one special character.</p> <p>By default, the option is disabled.</p>
Minimum Characters	Set the minimum characters allowed for password.

Table 37. System setup options—Passwords menu (continued)

Passwords	
<p>Password Bypass</p> <p>Password Changes</p> <p>Enable Non-Admin Password Changes</p>	<p>When enabled, this always prompts for system and internal hard drive passwords when powered on from the off state.</p> <p>By default, the Disabled option is selected.</p> <p>Enable or disable to change system and hard drive password without the need for admin password.</p> <p>By default, the option is enabled.</p>
Admin Setup Lockout	
<p>Enable Admin Setup Lockout</p>	<p>Enables administrators control over how their users can or cannot access BIOS setup.</p> <p>By default, the option is disabled.</p>
Master Password Lockout	
<p>Enable Master Password Lockout</p>	<p>When enabled, this disables the master password support.</p> <p>By default, the option is disabled.</p>
Allow Non-Admin PSID Revert	
<p>Enable Allow Non-Admin PSID Revert</p>	<p>Controls access to the Physical Security ID (PSID) revert of NVMe hard-drives from the Dell Security Manager prompt.</p> <p>By default, the option is disabled.</p>

Table 38. System setup options—Update, Recovery menu

Update, Recovery	
<p>UEFI Capsule Firmware Updates</p>	<p>Enable or disable BIOS updates through UEFI capsule update packages.</p> <p>i NOTE: Disabling this option will block BIOS updates from services such as Microsoft Windows Update and Linux Vendor Firmware Service (LVFS).</p> <p>By default, the option is enabled.</p>
<p>BIOS Recovery from Hard Drive</p>	<p>Enables the user to recover from certain corrupted BIOS conditions from a recovery file on the user primary hard drive or an external USB key.</p> <p>By default, the option is enabled.</p> <p>i NOTE: BIOS Recovery from Hard Drive is not available for self-encrypting drives (SED).</p>
<p>BIOS Downgrade</p> <p>Allow BIOS Downgrade</p>	<p>This field controls the flashing of the system firmware to previous revisions.</p> <p>By default, the option is enabled.</p>
<p>SupportAssist OS Recovery</p>	<p>Enable or disable the boot flow for SupportAssist OS Recovery tool in the event of certain system errors.</p> <p>By default, the option is enabled.</p>
<p>BIOSConnect</p>	<p>Enable or disable cloud Service operating system recovery if the main operating system fails to boot with the number of failures equal to or greater than the value specified by the Auto operating system Recovery Threshold setup option and local Service operating system does not boot or is not installed.</p> <p>By default, the option is enabled.</p>
<p>Dell Auto operating system Recovery Threshold</p>	<p>Controls the automatic boot flow for SupportAssist System Resolution Console and for Dell operating system Recovery Tool.</p>

Table 38. System setup options—Update, Recovery menu (continued)

Update, Recovery	
	By default, the threshold value is set to 2.

Table 39. System setup options—System Management menu

System Management	
Service Tag	Displays the Service Tag of the system.
Asset Tag	Create a system Asset Tag.
AC Behavior	
Wake on AC	Enable or disable the wake on AC option. By default, the option is disabled.
Auto on Time	Enable to set the system to turn on automatically every day or on a preselected date and time. This option can be configured only if the Auto On Time is set to Everyday, Weekdays, or Selected Days. By default, the option is disabled.

Table 40. System setup options—Keyboard menu

Keyboard	
Numlock Enable	Allows you to enable or disable the Numlock function when the system boots. By default, the option Fn Lock Options is enabled.
Fn Lock Options	By default, the Fn lock option is enabled.
Lock Mode	By default, the Lock Mode Secondary option is enabled. With this option, the F1-F2 keys scan the code for their secondary functions.

Table 41. System setup options—Pre-boot Behavior menu

Pre-boot Behavior	
Adapter Warnings	
Enable Adapter Warnings	Enable or disable the warning messages during boot when the adapters with less power capacity are detected. By default, the option is enabled.
Warning and Errors	Enable or disable the action to be done when a warning or error is encountered. By default, the Prompt on Warnings and Errors option is enabled.
USB-C Warnings	
Enable Dock Warning Messages	By default, the option is enabled.
Fastboot	Allows you to configure the speed of the UEFI boot process. By default, the Minimal option is enabled.
Extend BIOS POST Time	Set the BIOS POST load time. By default, the 0 seconds option is enabled.

Table 42. System setup options—Virtualization menu

Virtualization	
Intel Virtualization Technology	
Enable Intel Virtualization Technology (VT)	When enabled, the system will be able to run a Virtual Machine Monitor (VMM).

Table 42. System setup options—Virtualization menu (continued)

Virtualization	
VT for Direct I/O	<p>By default, the option is enabled.</p> <p>When enabled, the system will be able to perform Virtualization Technology for Direct I/O (VT-d).</p> <p>By default, the option is enabled.</p>
Intel Trusted Execution Technology (TXT)	
Enable Intel Trusted Execution Technology (TXT)	<p>Specifies whether a measured Virtual Machine Monitor (MVMM) can use the additional hardware capabilities that are provided by Intel Trusted Execution Technology. The following must be enabled in order to enable Intel TXT.</p> <ul style="list-style-type: none"> • Trusted Platform Module (TPM) • Intel Hyper-Threading • All CPU cores (Multi-Core Support) • Intel Virtualization Technology • Intel VT for Direct I/O <p>By default, the option is disabled.</p>

Table 43. System setup options—Performance menu

Performance	
Multi Core Support	
Active Cores	<p>Enables to change the number of CPU cores available to the operating system.</p> <p>By default, the All Cores option is enabled.</p>
Intel SpeedStep	
Enable Intel SpeedStep Technology	<p>Enables the system to dynamically adjust processor voltage and core frequency, decreasing average power consumption and heat production.</p> <p>By default, the option is enabled.</p>
C-States Control	
Enable C-State Control	<p>Enable the ability of the CPU to enter and exit low power state. When disabled, it disabled all C-states. When enabled, it enabled all C-states that the chipset or platform allows.</p> <p>By default, the option is enabled.</p>
Intel Turbo Boost Technology	
Enable Intel Turbo Boost Technology	<p>Enable or disable the Intel TurboBoost mode of the processor.</p> <p>By default, the option is enabled.</p>
Intel Hyper-Threading Technology	
Enable Intel Hyper-Threading Technology	<p>Enable or disable Hyper-Threading in the processor.</p> <p>By default, the option is enabled.</p>
Dynamic Tuning:Machine Learning	
Enable Dynamic Tuning:Machine Learning	<p>Enables the operating system capability to enhance dynamic power tuning capabilities based on detected workloads.</p> <p>By default, the option is disabled.</p>

Table 44. System setup options—System Logs menu

System Logs	
BIOS Event Log	
Clear Bios Event Log	Displays BIOS events. By default, the Keep Log option is enabled.
Thermal Event Log	
Clear Thermal Event Log	Displays Thermal events. By default, the Keep Log option is enabled.
Power Event Log	
Clear Power Event Log	Displays power events. By default, the Keep Log option is enabled.
License Information	Displays the license information of the system.

Updating the BIOS

Updating the BIOS in Windows

Steps

1. Go to www.dell.com/support.
2. Click **Product support**. In the **Search support** box, enter the Service Tag of your computer, and then click **Search**.
 **NOTE:** If you do not have the Service Tag, use the SupportAssist feature to automatically identify your computer. You can also use the product ID or manually browse for your computer model.
3. Click **Drivers & Downloads**. Expand **Find drivers**.
4. Select the operating system installed on your computer.
5. In the **Category** drop-down list, select **BIOS**.
6. Select the latest version of BIOS, and click **Download** to download the BIOS file for your computer.
7. After the download is complete, browse the folder where you saved the BIOS update file.
8. Double-click the BIOS update file icon and follow the on-screen instructions.
For more information about how to update the system BIOS, search in the Knowledge Base Resource at www.dell.com/support.

Updating the BIOS using the USB drive in Windows

Steps

1. Follow the procedure from step 1 to step 6 in [Updating the BIOS in Windows](#) to download the latest BIOS setup program file.
2. Create a bootable USB drive. For more information, search the Knowledge Base Resource at www.dell.com/support.
3. Copy the BIOS setup program file to the bootable USB drive.
4. Connect the bootable USB drive to the computer that needs the BIOS update.
5. Restart the computer and press **F12**.
6. Select the USB drive from the **One Time Boot Menu**.
7. Type the BIOS setup program filename and press **Enter**.
The **BIOS Update Utility** appears.
8. Follow the on-screen instructions to complete the BIOS update.

Updating the BIOS in Linux and Ubuntu

To update the system BIOS on a computer that is installed with Linux or Ubuntu, see the knowledge base article [000131486](https://www.dell.com/support) at www.dell.com/support.

Updating the BIOS from the F12 One-Time boot menu

Update your computer BIOS using the BIOS update.exe file that is copied to a FAT32 USB drive and booting from the F12 One-Time boot menu.

About this task

BIOS Update

You can run the BIOS update file from Windows using a bootable USB drive or you can also update the BIOS from the F12 One-Time boot menu on the computer.

Most of the Dell computers built after 2012 have this capability, and you can confirm by booting your computer to the F12 One-Time Boot Menu to see if BIOS FLASH UPDATE is listed as a boot option for your computer. If the option is listed, then the BIOS supports this BIOS update option.

 **NOTE:** Only computers with BIOS Flash Update option in the F12 One-Time boot menu can use this function.

Updating from the One-Time boot menu

To update your BIOS from the F12 One-Time boot menu, you need the following:

- USB drive formatted to the FAT32 file system (key does not have to be bootable)
- BIOS executable file that you downloaded from the Dell Support website and copied to the root of the USB drive
- AC power adapter that is connected to the computer
- Functional computer battery to flash the BIOS

Perform the following steps to perform the BIOS update flash process from the F12 menu:

 **CAUTION:** Do not turn off the computer during the BIOS update process. The computer may not boot if you turn off your computer.

Steps

1. From a turn off state, insert the USB drive where you copied the flash into a USB port of the computer.
2. Turn on the computer and press F12 to access the One-Time Boot Menu, select BIOS Update using the mouse or arrow keys then press Enter.
The flash BIOS menu is displayed.
3. Click **Flash from file**.
4. Select external USB device.
5. Select the file and double-click the flash target file, and then click **Submit**.
6. Click **Update BIOS**. The computer restarts to flash the BIOS.
7. The computer will restart after the BIOS update is completed.

System and setup password

Table 45. System and setup password

Password type	Description
System password	Password that you must enter to log in to your system.
Setup password	Password that you must enter to access and make changes to the BIOS settings of your computer.

You can create a system password and a setup password to secure your computer.

 **CAUTION:** The password features provide a basic level of security for the data on your computer.

 **CAUTION:** Anyone can access the data that is stored on your computer if it is not locked and left unattended.

 **NOTE:** System and setup password feature is disabled.

Assigning a system setup password

Prerequisites

You can assign a new **System or Admin Password** only when the status is in **Not Set**.

About this task

To enter the system setup, press F12 immediately after a power-on or reboot.

Steps

1. In the **System BIOS** or **System Setup** screen, select **Security** and press Enter.
The **Security** screen is displayed.
2. Select **System/Admin Password** and create a password in the **Enter the new password** field.
Use the following guidelines to assign the system password:
 - A password can have up to 32 characters.
 - At least one special character: ! " # \$ % & ' () * + , - . / : ; < = > ? @ [\] ^ _ ` { | }
 - Numbers 0 through 9.
 - Upper case letters from A to Z.
 - Lower case letters from a to z.
3. Type the system password that you entered earlier in the **Confirm new password** field and click **OK**.
4. Press Esc and save the changes as prompted by the pop-up message.
5. Press Y to save the changes.
The computer restarts.

Deleting or changing an existing system setup password

Prerequisites

Ensure that the **Password Status** is Unlocked (in the System Setup) before attempting to delete or change the existing System and/or Setup password. You cannot delete or change an existing System or Setup password, if the **Password Status** is Locked.

About this task

To enter the System Setup, press F12 immediately after a power-on or reboot.

Steps

1. In the **System BIOS** or **System Setup** screen, select **System Security** and press Enter.
The **System Security** screen is displayed.
2. In the **System Security** screen, verify that **Password Status** is **Unlocked**.
3. Select **System Password**, update, or delete the existing system password, and press Enter or Tab.
4. Select **Setup Password**, update, or delete the existing setup password, and press Enter or Tab.
 **NOTE:** If you change the System and/or Setup password, reenter the new password when prompted. If you delete the System and/or Setup password, confirm the deletion when prompted.
5. Press Esc and a message prompts you to save the changes.
6. Press Y to save the changes and exit from System Setup.
The computer restarts.

Clearing CMOS settings

About this task

 **CAUTION:** Clearing CMOS settings will reset the BIOS settings on your computer.

Steps

1. Remove the [base cover](#).
2. Disconnect the battery cable from the system board.
3. Remove the [coin-cell battery](#).
4. Wait for one minute.
5. Replace the [coin-cell battery](#).
6. Connect the battery cable to the system board.
7. Replace the [base cover](#).

Clearing BIOS (System Setup) and System passwords

About this task

To clear the system or BIOS passwords, contact Dell technical support as described at www.dell.com/contactdell.

 **NOTE:** For information on how to reset Windows or application passwords, refer to the documentation accompanying Windows or your application.

Troubleshooting

Handling swollen Lithium-ion batteries

Like most laptops, Dell laptops use lithium-ion batteries. One type of lithium-ion battery is the lithium-ion polymer battery. Lithium-ion polymer batteries have increased in popularity in recent years and have become standard in the electronics industry due to customer preferences for a slim form factor (especially with newer ultra-thin laptops) and long battery life. Inherent to lithium-ion polymer battery technology is the potential for swelling of the battery cells.

Swollen battery may impact the performance of the laptop. To prevent possible further damage to the device enclosure or internal components leading to malfunction, discontinue the use of the laptop and discharge it by disconnecting the AC adapter and letting the battery drain.

Swollen batteries should not be used and should be replaced and disposed of properly. We recommend contacting Dell product support for options to replace a swollen battery under the terms of the applicable warranty or service contract, including options for replacement by a Dell authorized service technician.

The guidelines for handling and replacing Lithium-ion batteries are as follows:

- Exercise caution when handling Lithium-ion batteries.
- Discharge the battery before removing it from the system. To discharge the battery, unplug the AC adapter from the system and operate the system only on battery power. When the system will no longer power on when the power button is pressed, the battery is fully discharged.
- Do not crush, drop, mutilate, or penetrate the battery with foreign objects.
- Do not expose the battery to high temperatures, or disassemble battery packs and cells.
- Do not apply pressure to the surface of the battery.
- Do not bend the battery.
- Do not use tools of any type to pry on or against the battery.
- If a battery gets stuck in a device as a result of swelling, do not try to free it as puncturing, bending, or crushing a battery can be dangerous.
- Do not attempt to reassemble a damaged or swollen battery into a laptop.
- Swollen batteries that are covered under warranty should be returned to Dell in an approved shipping container (provided by Dell)—this is to comply with transportation regulations. Swollen batteries that are not covered under warranty should be disposed of at an approved recycling center. Contact Dell product support at <https://www.dell.com/support> for assistance and further instructions.
- Using a non-Dell or incompatible battery may increase the risk of fire or explosion. Replace the battery only with a compatible battery purchased from Dell that is designed to work with your Dell computer. Do not use a battery from other computers with your computer. Always purchase genuine batteries from <https://www.dell.com> or otherwise directly from Dell.

Lithium-ion batteries can swell for various reasons such as age, number of charge cycles, or exposure to high heat. For more information on how to improve the performance and lifespan of the laptop battery and to minimize the possibility of occurrence of the issue, search Dell Laptop Battery in the Knowledge Base Resource at www.dell.com/support.

Locate the Service Tag or Express Service Code of your Dell computer

Your Dell computer is uniquely identified by a Service Tag or Express Service Code. To view relevant support resources for your Dell computer, we recommend entering the Service Tag or Express Service Code at www.dell.com/support.

For more information on how to find the Service Tag for your computer, see [Locate the Service Tag for your Dell Laptop](#).

Dell SupportAssist Pre-boot System Performance Check diagnostics

About this task

SupportAssist diagnostics (also known as system diagnostics) performs a complete check of your hardware. The Dell SupportAssist Pre-boot System Performance Check diagnostics is embedded with the BIOS and is launched by the BIOS internally. The embedded system diagnostics provides a set of options for particular devices or device groups allowing you to:

- Run tests automatically or in an interactive mode
- Repeat tests
- Display or save test results
- Run thorough tests to introduce additional test options to provide extra information about the failed device(s)
- View status messages that inform you if tests are completed successfully
- View error messages that inform you of problems encountered during testing

 **NOTE:** Some tests for specific devices require user interaction. Always ensure that you are present at the computer terminal when the diagnostic tests are performed.

For more information, see <https://www.dell.com/support/kbdoc/000180971>.

Running the SupportAssist Pre-Boot System Performance Check

Steps

1. Turn on your computer.
2. As the computer boots, press the F12 key as the Dell logo appears.
3. On the boot menu screen, select the **Diagnostics** option.
4. Click the arrow at the bottom left corner.
Diagnostics front page is displayed.
5. Click the arrow in the lower-right corner to go to the page listing.
The items detected are listed.
6. To run a diagnostic test on a specific device, press Esc and click **Yes** to stop the diagnostic test.
7. Select the device from the left pane and click **Run Tests**.
8. If there are any issues, error codes are displayed.
Note the error code and validation number and contact Dell.

Built-in self-test (BIST)

M-BIST

M-BIST (Built In Self-Test) is the system board's built-in self-test diagnostics tool that improves the diagnostics accuracy of system board embedded controller (EC) failures.

 **NOTE:** M-BIST can be manually initiated before POST (Power On Self Test).

How to run M-BIST

 **NOTE:** M-BIST must be initiated on the system from a power-off state either connected to AC power or with battery only.

1. Press and hold both the **M** key on the keyboard and the **power button** to initiate M-BIST.
2. With both the **M** key and the **power button** held down, the battery indicator LED may exhibit two states:
 - a. OFF: No fault detected with the system board
 - b. AMBER: Indicates a problem with the system board
3. If there is a failure with the system board, the battery status LED will flash one of the following error codes for 30 seconds:

Table 46. LED error codes

Blinking Pattern		Possible Problem
Amber	White	
2	1	CPU Failure
2	8	LCD Power Rail Failure
1	1	TPM Detection Failure
2	4	Unrecoverable SPI Failure

4. If there is no failure with the system board, the LCD will cycle through the solid color screens described in the LCD-BIST section for 30 seconds and then power off.

LCD Power rail test (L-BIST)

L-BIST is an enhancement to the single LED error code diagnostics and is automatically initiated during POST. L-BIST will check the LCD power rail. If there is no power being supplied to the LCD (i.e., the L-BIST circuit fails), the battery status LED will flash either an error code [2,8] or an error code [2,7].

 **NOTE:** If L-BIST fails, LCD-BIST cannot function as no power will be supplied to the LCD.

How to invoke L-BIST Test:

1. Press the power button to start the system.
2. If the system does not start up normally, look at the battery status LED:
 - If the battery status LED flashes an error code [2,7], the display cable may not be connected properly.
 - If the battery status LED flashes an error code [2,8], there is a failure on the LCD power rail of the system board, hence there is no power supplied to the LCD.
3. For cases, when a [2,7] error code is shown, check to see if the display cable is properly connected.
4. For cases when a [2,8] error code is shown, replace the system board.

LCD Built-in Self Test (BIST)

Dell laptops have a built-in diagnostic tool that helps you determine if the screen abnormality you are experiencing is an inherent problem with the LCD (screen) of the Dell laptop or with the video card (GPU) and PC settings.

When you notice screen abnormalities like flickering, distortion, clarity issues, fuzzy or blurry image, horizontal or vertical lines, color fade etc., it is always a good practice to isolate the LCD (screen) by running the Built-In Self Test (BIST).

How to invoke LCD BIST Test

1. Power off the Dell laptop.
2. Disconnect any peripherals that are connected to the laptop. Connect only the AC adapter (charger) to the laptop.
3. Ensure that the LCD (screen) is clean (no dust particles on the surface of the screen).
4. Press and hold **D** key and **Power on** the laptop to enter LCD built-in self test (BIST) mode. Continue to hold the D key, until the system boots up.
5. The screen will display solid colors and change colors on the entire screen to white, black, red, green, and blue twice.
6. Then it will display the colors white, black and red.
7. Carefully inspect the screen for abnormalities (any lines, fuzzy color or distortion on the screen).
8. At the end of the last solid color (red), the system will shut down.

 **NOTE:** Dell SupportAssist Pre-boot diagnostics upon launch, initiates an LCD BIST first, expecting a user intervention confirm functionality of the LCD.

System-diagnostic lights

This section lists the system-diagnostic lights of your Vostro 16 5635.

Table 47. System-diagnostic lights

Blinking pattern		Problem description
Amber	White	
1	1	TPM detection failure
1	2	Unrecoverable SPI flash failure
1	3	Short in hinge cable tripped OCP1
1	4	Short in hinge cable tripped OCP2
1	5	EC unable to program i-Fuse
1	6	EC internal failure
2	1	Processor failure
2	2	System board: BIOS or ROM (Read-Only Memory) failure
2	3	No memory or RAM (Random-Access Memory) detected
2	4	Memory or RAM (Random-Access Memory) failure
2	5	Invalid memory installed
2	6	System-board or chipset error
2	7	Display failure - SBIOS message
2	8	Display failure - EC detection of power rail failure
3	1	CMOS battery failure
3	2	PCI, video card/chip failure
3	3	BIOS recovery image not found
3	4	Recovery image found but invalid
3	5	Power-rail failure
3	6	System BIOS Flash incomplete
3	7	Management Engine (ME) error

NOTE: Blinking 3-3-3 LEDs on Lock LED (Caps-Lock or Num-Lock), Power button LED (without Fingerprint reader), and Diagnostic LED indicates failure to provide input during LCD panel test on Dell SupportAssist Pre-boot System Performance Check diagnostics.

Recovering the operating system

When your computer is unable to boot to the operating system even after repeated attempts, it automatically starts Dell SupportAssist OS Recovery.

Dell SupportAssist OS Recovery is a standalone tool that is preinstalled in all Dell computers installed with Windows operating system. It consists of tools to diagnose and troubleshoot issues that may occur before your computer boots to the operating system. It enables you to diagnose hardware issues, repair your computer, back up your files, or restore your computer to its factory state.

You can also download it from the Dell Support website to troubleshoot and fix your computer when it fails to boot into their primary operating system due to software or hardware failures.

For more information about the Dell SupportAssist OS Recovery, see *Dell SupportAssist OS Recovery User's Guide* at www.dell.com/serviceabilitytools. Click **SupportAssist** and then, click **SupportAssist OS Recovery**.

Real-Time Clock (RTC Reset)

The Real Time Clock (RTC) reset function allows you or the service technician to recover Dell systems from No POST/No Power/No Boot situations. The legacy jumper enabled RTC reset has been retired on these models.

Start the RTC reset with the system powered off and connected to AC power. Press and hold the power button for thirty (30) seconds

. The system RTC Reset occurs after you release the power button.

Backup media and recovery options

It is recommended to create a recovery drive to troubleshoot and fix problems that may occur with Windows. Dell proposes multiple options for recovering Windows operating system on your Dell PC. For more information, see [Dell Windows Backup Media and Recovery Options](#).

WiFi power cycle

About this task

If your computer is unable to access the internet due to WiFi connectivity issues a WiFi power cycle procedure may be performed. The following procedure provides the instructions on how to conduct a WiFi power cycle:

 **NOTE:** Some ISPs (Internet Service Providers) provide a modem/router combo device.

Steps

1. Turn off your computer.
2. Turn off the modem.
3. Turn off the wireless router.
4. Wait for 30 seconds.
5. Turn on the wireless router.
6. Turn on the modem.
7. Turn on your computer.

Drain residual flea power (perform hard reset)

About this task

Flea power is the residual static electricity that remains in the computer even after it has been powered off and the battery is removed.

For your safety, and to protect the sensitive electronic components in your computer, you are requested to drain residual flea power before removing or replacing any components in your computer.

Draining residual flea power, also known as a performing a "hard reset", is also a common troubleshooting step if your computer does not power on or boot into the operating system.

To drain residual flea power (perform a hard reset)

Steps

1. Turn off your computer.

2. Disconnect the power adapter from your computer.
3. Remove the base cover.
4. Remove the battery.
5. Press and hold the power button for 20 seconds to drain the flea power.
6. Install the battery.
7. Install the base cover.
8. Connect the power adapter to your computer.
9. Turn on your computer.



 **NOTE:** For more information about performing a hard reset, search in the Knowledge Base Resource at www.dell.com/support.

Getting help and contacting Dell

Self-help resources

You can get information and help on Dell products and services using these self-help resources:

Table 48. Self-help resources

Self-help resources	Resource location
Information about Dell products and services	www.dell.com
My Dell app	
Tips	
Contact Support	In Windows search, type <code>Contact Support</code> , and press Enter.
Online help for operating system	www.dell.com/support/windows www.dell.com/support/linux
Access top solutions, diagnostics, drivers and downloads, and learn more about your computer through videos, manuals and documents.	Your Dell computer is uniquely identified by a Service Tag or Express Service Code. To view relevant support resources for your Dell computer, enter the Service Tag or Express Service Code at www.dell.com/support . For more information on how to find the Service Tag for your computer, see Locate the Service Tag on your computer .
Dell knowledge base articles for a variety of computer concerns	<ol style="list-style-type: none"> 1. Go to www.dell.com/support. 2. On the menu bar at the top of the Support page, select Support > Knowledge Base. 3. In the Search field on the Knowledge Base page, type the keyword, topic, or model number, and then click or tap the search icon to view the related articles.

Contacting Dell

To contact Dell for sales, technical support, or customer service issues, see www.dell.com/contactdell.

 **NOTE:** Availability varies by country/region and product, and some services may not be available in your country/region.

 **NOTE:** If you do not have an active Internet connection, you can find contact information about your purchase invoice, packing slip, bill, or Dell product catalog.